

KH 891

HOW TO USE KNITTING MACHINE

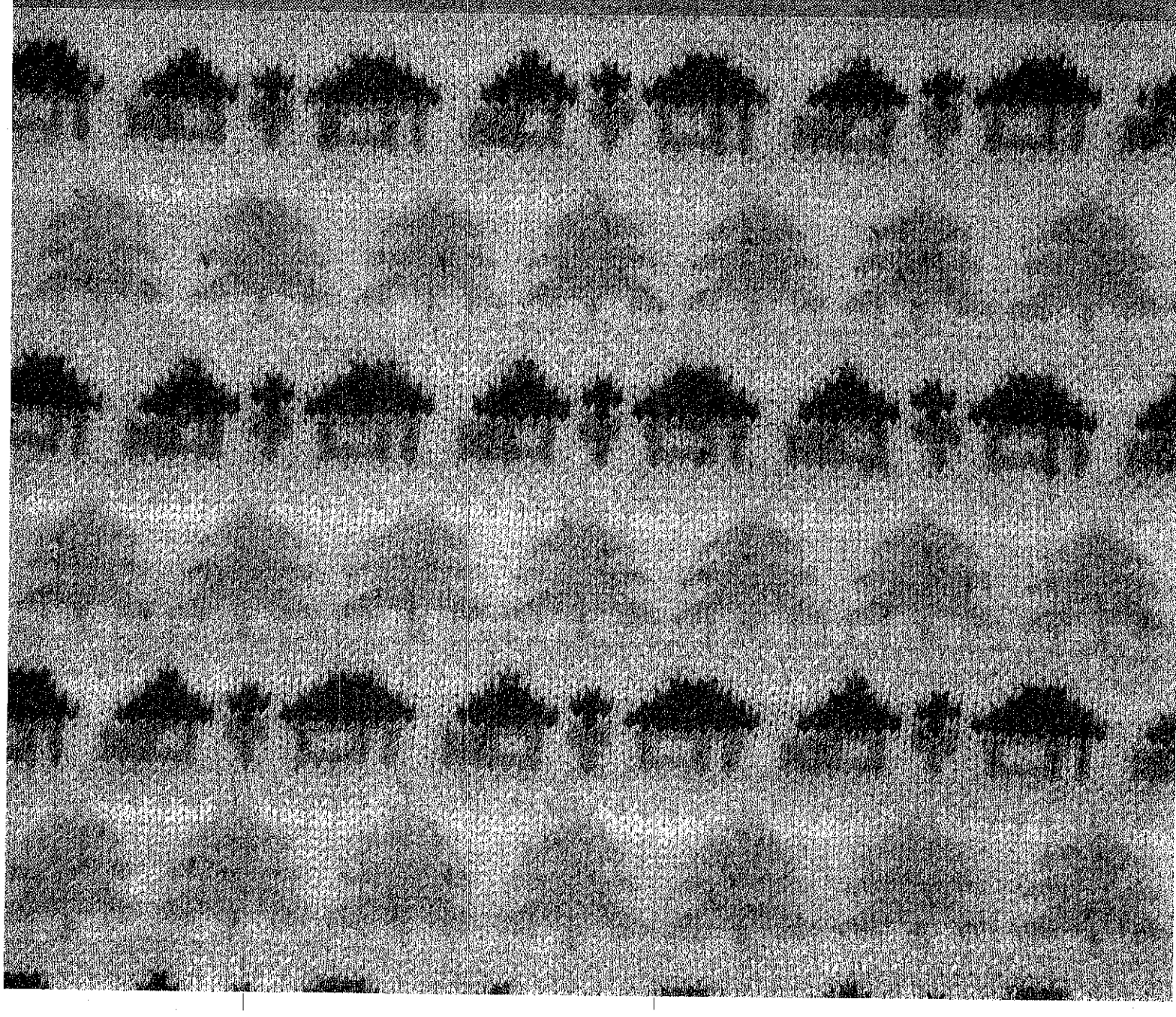

LESSON 1

1. HOW TO USE KNITTING MACHINE	5
1-1. SETTING UP KNITTING MACHINE	5
1-2. REPLACING KNITTING MACHINE IN CARRYING CASE	11
2. HERE ARE A FEW IMPORTANT POINTS TO REMEMBER BEFORE YOU START KNITTING	15
2-1. PREPARATION OF YARN	15
2-2. THREADING THE YARN TENSION UNIT	16
2-3. NEEDLE POSITION	18
2-4. NAME OF PARTS K CARRIAGE	18
2-5. RELATION BETWEEN THE TENSION DIAL AND YARN	19
3. BASIC OPERATION PRACTICE I (PLAIN KNITTING)	20
3-1. PLAIN KNITTING	20
3-2. HOW TO REMOVE THE KNITTING FROM THE MACHINE	23
3-3. HOW TO CAST ON WITH A FINISHED EDGE.....	24
3-3-1. Hand method	24
3-3-2. Latch tool.....	25
3-3-3. Using the Weaving pattern lever and 1/1 Needle pusher	27
4. KNOWLEDGE OF PLAIN KNITTING	28
4-1. WHEN YOU CANNOT CAST ON	28
4-1-1. When the needles do not catch the yarn	28
4-2. WHEN THE K CARRIAGE IS HARD TO PUSH	28
4-3. IF THE K CARRIAGE SHOULD JAM	29

LESSON 2

5. BASIC OPERATION PRACTICE II (PATTERN KNITTING)	33
5-1. PUNCH CARD	40
5-2. RELATION BETWEEN THE PUNCH CARD AND THE NEEDLES	42
HOW TO CHANGE THE SELECTION GUIDE FOR END NEEDLE.....	43
5-3. PREPARATION FOR PATTERN KNITTING	44
5-3-1. Setting the Punch card	44
5-3-2. Preparation for pattern knitting	45
5-4. TUCK STITCH PATTERNS, SKIP STITCH PATTERNS	46
5-5. TWO COLOR TUCK STITCH PATTERNS TWO COLOR SKIP STITCH PATTERNS	48
5-6. FAIR-ISLE PATTERNS	50
5-7. FAIR-ISLE MOTIF	52
5-7-1. How to connect the Motif knitting cam	53
5-7-2. Preparation for Fair-isle Motif and How to knit	54
5-7-3. Double Fair-isle motif	56
5-8. DOUBLE LENGTH PATTERNS	59
5-8-1. Preparation for Double length patterns	58
5-8-2. When knitting Normal and Double length patterns mixed	59
5-9. WEAVING PATTERNS	59
5-10. PLATING YARN KNITTING	62
5-11. INTARSIA KNITTING	64
5-12. HOW TO DESIGN OWN CARDS	67
6. KNOWLEDGE OF PATTERN KNITTING	68
6-1. IF YOU MAKE MISTAKES IN PATTERN KNITTING USING THE PUNCH CARDS HOW TO CORRECT THEM	68
6-1-1. If the K carriage should jam	68
6-2. IF YOU MAKE MISTAKES ON KNITTING DOUBLE LENGTH PATTERNS HOW TO CORRECT THEM	72
7. BASIC OPERATION PRACTICE III (LACE PATTERN KNITTING)	73
7-1. LACE PATTERN KNITTING	73
7-2. HOW TO SET THE L CARRIAGE	73
7-3. LACE PATTERN KNITTING. FINE-LACE PATTERN KNITTING	74
7-4. WHEN KNITTING LACE AND FINE-LACE PATTERN MIXED	77
7-5. HOW TO USE THE L-POINT CAM	78
8. KNOWLEDGE OF LACE PATTERN KNITTING	80
8-1. IF THE L CARRIAGE SHOULD JAM	80
8-2. UNRAVELLING THE KNITTING	82

LESSON 3

9. MAKING A GARMENT		83
9-1. HOW TO USE THE TRANSFER TOOL AND THE LATCH TOOL		83
9-1-1. Transfer tool		83
9-1-2. Latch tool		84
9-2. INCREASING AND DECREASING STITCHES		
PICKING UP DROPPED STITCHES		85
9-2-1. Increasing stitches		85
9-2-1-1. Increasing one stitch at either edge of the knitting.		
Simple method		85
9-2-1-2. Increasing one stitch at either edge of the knitting.		
Full fashioned method		85
9-2-1-3. Increasing several stitches at either edge of the knitting		85
9-2-2. Decreasing stitches		86
9-2-2-1. Decreasing one stitch at either edge of the knitting.		
Simple method		86
9-2-2-2. Decreasing one stitch at either edge of the knitting.		
Full fashioned method		87
9-2-2-3. Decreasing several stitches at either edge of the knitting		87
9-2-3. Picking up dropped stitches		88
9-2-3-1. Repairing a dropped stitch		88
9-2-3-2. Repairing a stitch that the dropped several rows		89
9-3. HOW TO MAKE A HEM		90
9-3-1. Plain hem		90
9-3-2. Picot hem		92
9-3-3. 1 x 1 Elastic hem		94
9-4. BINDING OFF AND BUTTON HOLE		95
9-4-1. Binding off using the tapestry needle		95
9-4-1-1. When the yarn is on the left side		95
9-4-1-2. When the yarn is on the right side		96
9-4-2. Cast-off using the latch tool		97
9-4-3. Vertical seaming of plain stitch		98
9-4-4. How to make a button hole		99
9-5. HOW TO SHAPE A ROUND NECK LINE		100
9-5-1. Using the holding cam lever		100
9-5-1-1. Plain knitting		100
9-5-1-2. Pattern knitting		101
9-5-2. Using the cast-on thread		
(Lace Pattern knitting)		103

9-6. SEWING PROCEDURE	105
9-6-1. Baste the knitting with binding wire and/or basting thread	105
9-6-2. Sewing procedure	106
9-7. CLEANING AND MAINTENANCE	106
9-7-1. Replacing a needle	106
9-7-2. Cleaning and maintenance	107

10. USEFUL HINTS	108
-------------------------	------------

10-1. PARTIAL KNITTING (PLAIN KNITTING & PATTERN KNITTING)	108
10-1-1. Decreasing stitches	109
10-1-2. Increasing stitches	110
10-2. PARTIAL KNITTING (LACE PATTERN KNITTING)	111
10-2-1. Decreasing stitches	111
10-2-2. Increasing stitches	111
10-3. TUBE KNITTING	112

LESSON 1

1. HOW TO USE KNITTING MACHINE

1-1. SETTING UP KNITTING MACHINE



Place the machine on a firm table, with the CARRYING CASE HANDLE away from you.

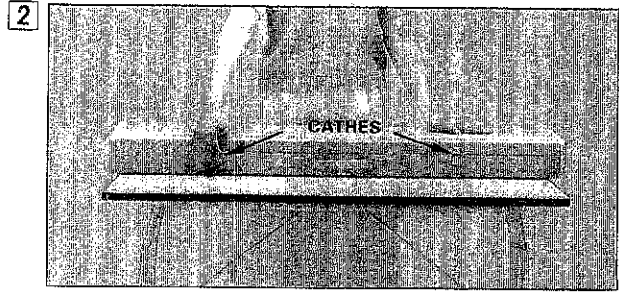

Unlock the CATCHES on either side of handle.

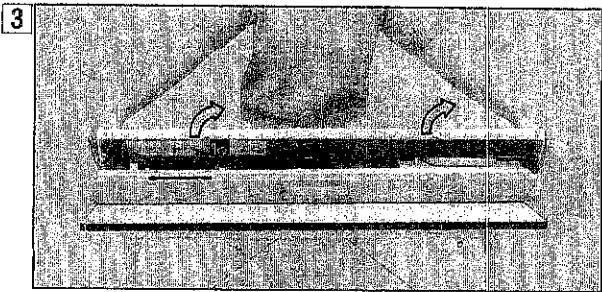

Lift the UPPER CASE slightly, and pull toward you to release the lid.

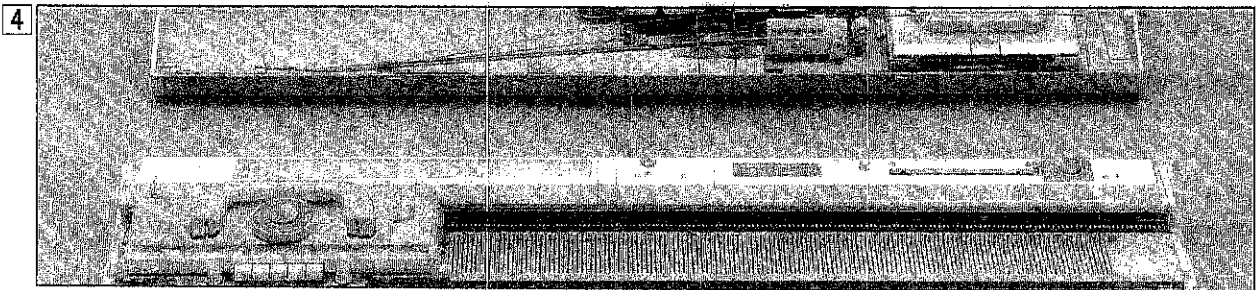

After releasing the lid.

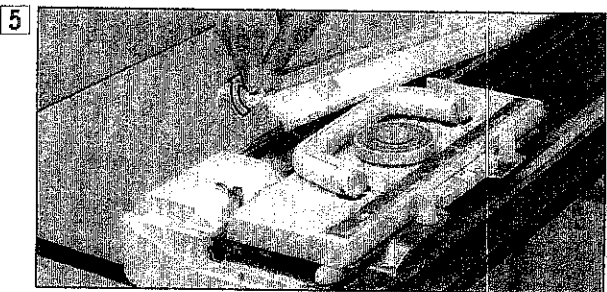

Take the two TABLE CLAMPS out of the accessory box.

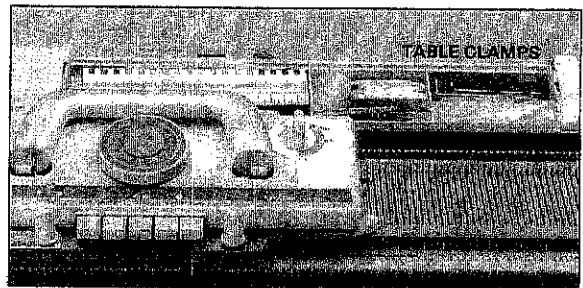

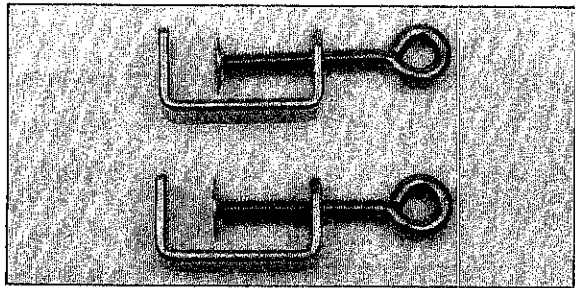
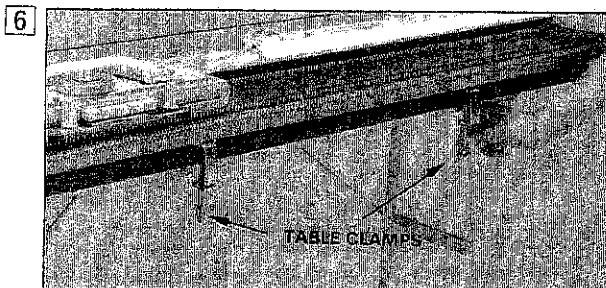
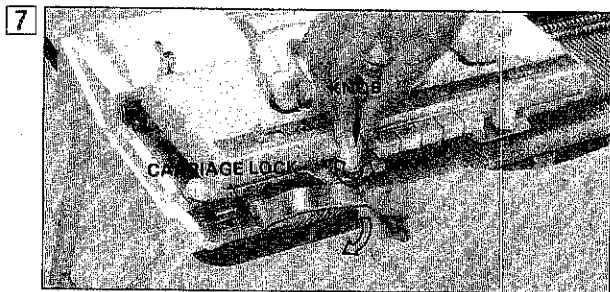

TABLE CLAMPS.



Fasten the machine to the table by tightening the TABLE CLAMP SCREW.



Loosen the KNOB and remove the CARRIAGE LOCK.

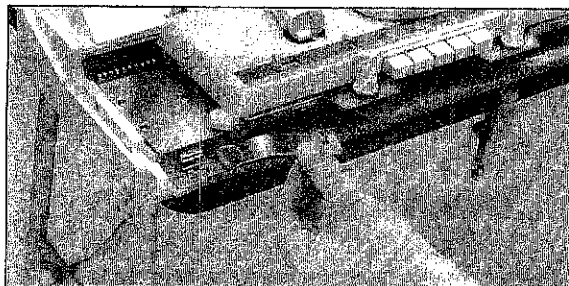

Remove the ROW COUNTER from the carrying case.
1) Push the ROW COUNTER toward you.
2) Lift it up to remove.

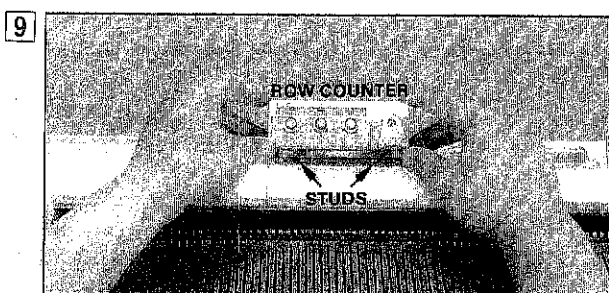

Set the ROW COUNTER up on the two STUDS at the center of the machine.
1) Set the ROW COUNTER onto the two STUDS.

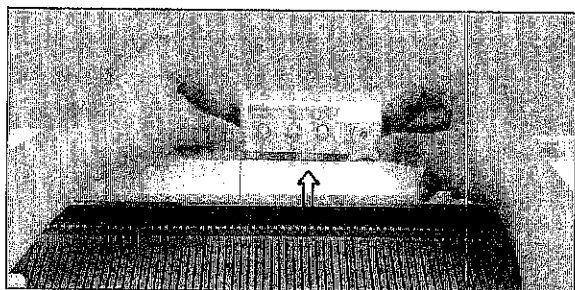

2) Push it away from you.

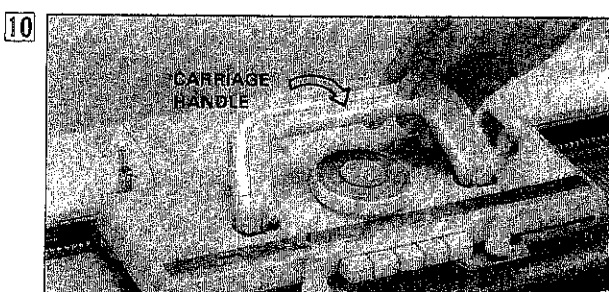

Pull the CARRIAGE HANDLE up towards you.

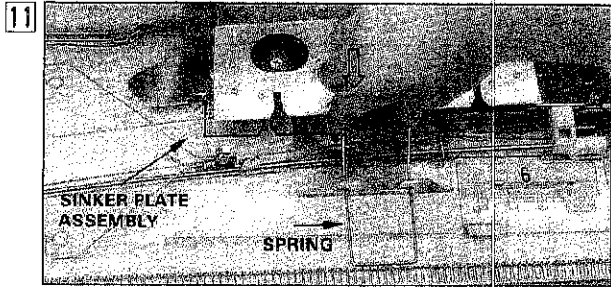

Press down the SPRING and remove it from the HOOK.

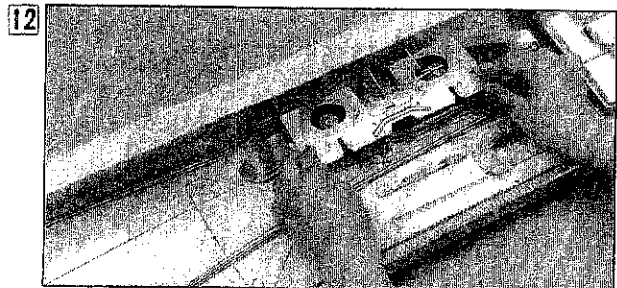

Remove the SINKER PLATE ASSEMBLY from the carrying case.

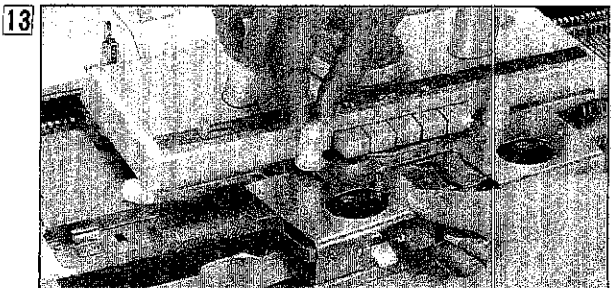

Setting up the SINKER PLATE ASSEMBLY on the K CARRIAGE.

1) Loosen the KNOBS and insert the SINKER PLATE ASSEMBLY under the knobs.

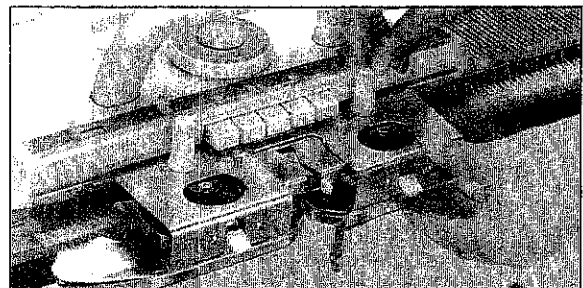

2) Be sure to tighten the knobs so the SINKER PLATE ASSEMBLY will fit securely.

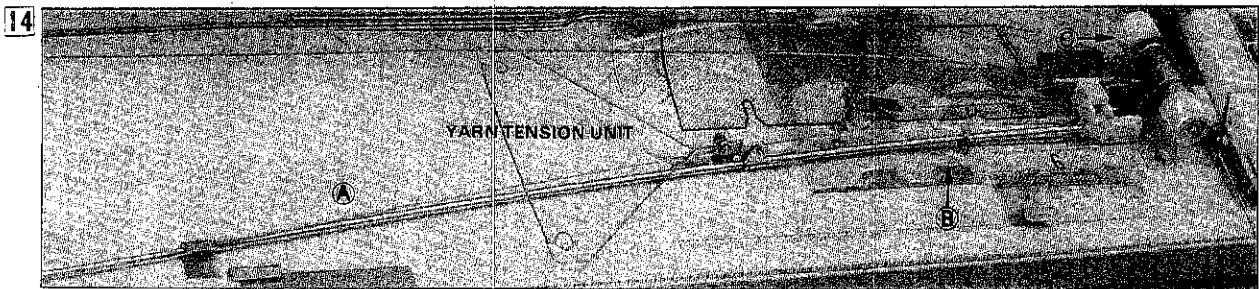

Remove the YARN TENSION UNIT from the carrying case. Take it out of the carrying case in the order of A, B and C.

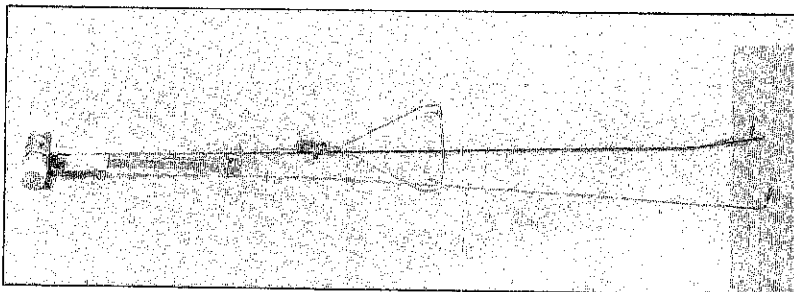

YARN TENSION UNIT.

Setting the YARN TENSION UNIT.

15

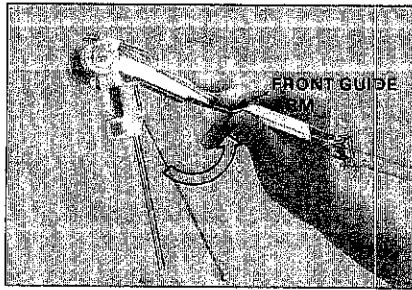

- 1) Turn the FRONT GUIDE ARM forward in the direction of the arrow.

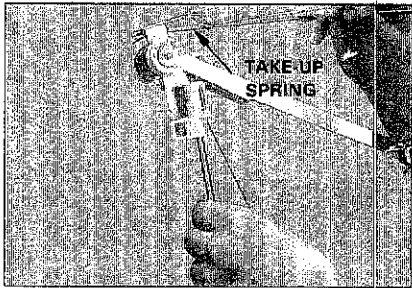

- 2) Turn back the TAKE-UP SPRINGS as far as they will go.

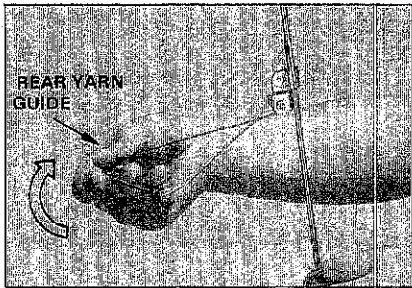

- 3) Raise the REAR YARN GUIDE until it is perpendicular to the rod.

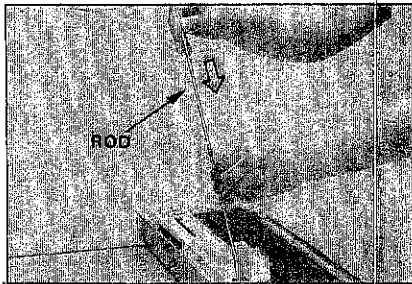

- 4) Insert the end of the ROD into the hole for this purpose at the center of the machine.

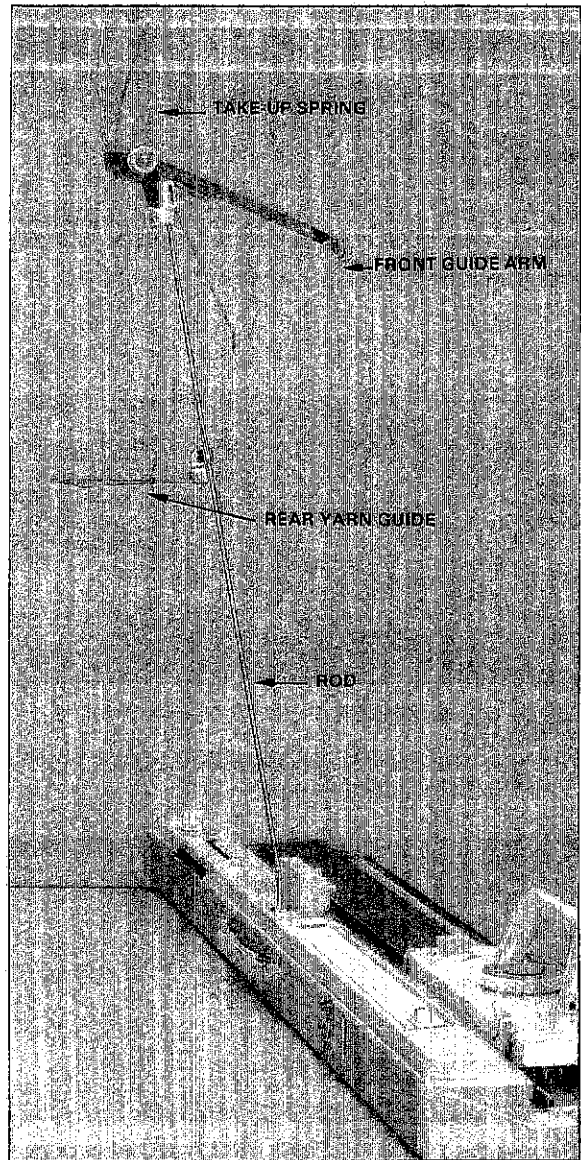

The REAR YARN GUIDE should lean backwards.

16

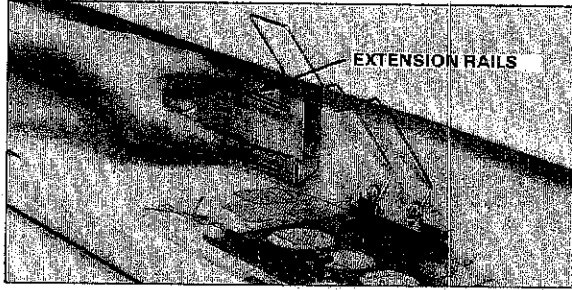

Remove the EXTENSION RAILS from the carrying case and set them up on both sides of the machine.

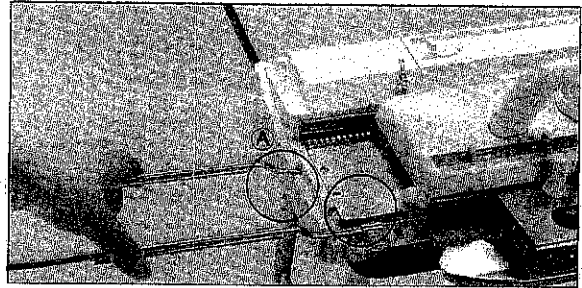

1) Insert EXTENSION RAILS into the holes (A and B) at the both sides of the machine.

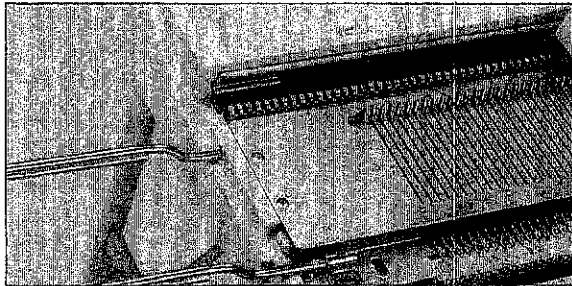

2) Set up the EXTENSION RAILS securely to prevent K CARRIAGE from dropping off.

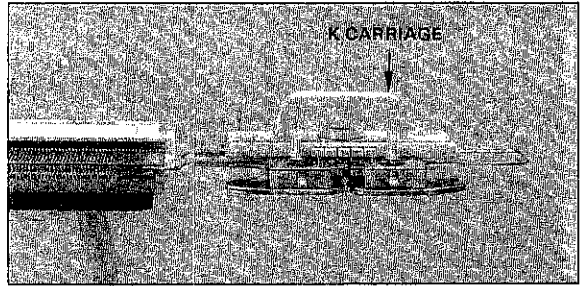

17

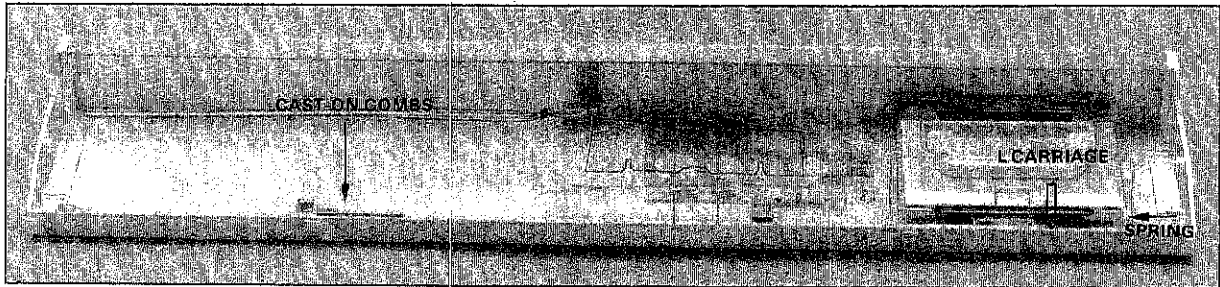

Press down the SPRING and remove the CAST-ON COMBS from the carrying case.

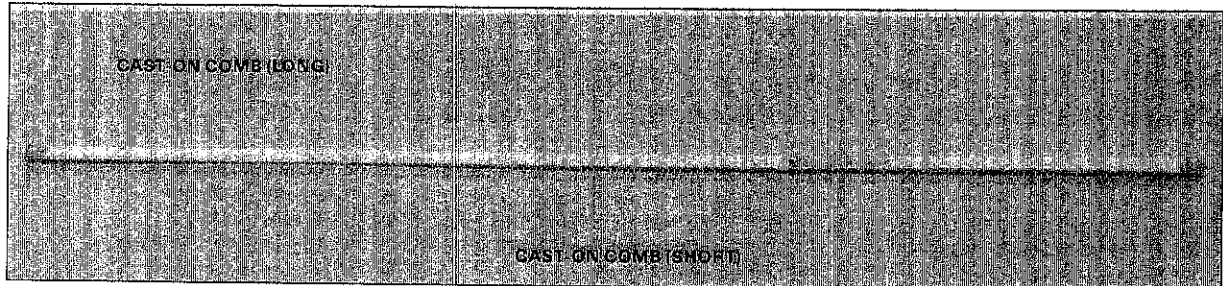

18

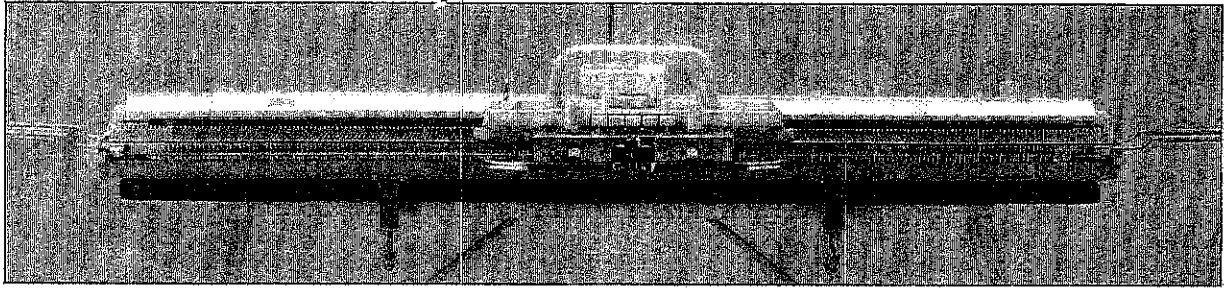

After setting up your machine, put the carrying case away.

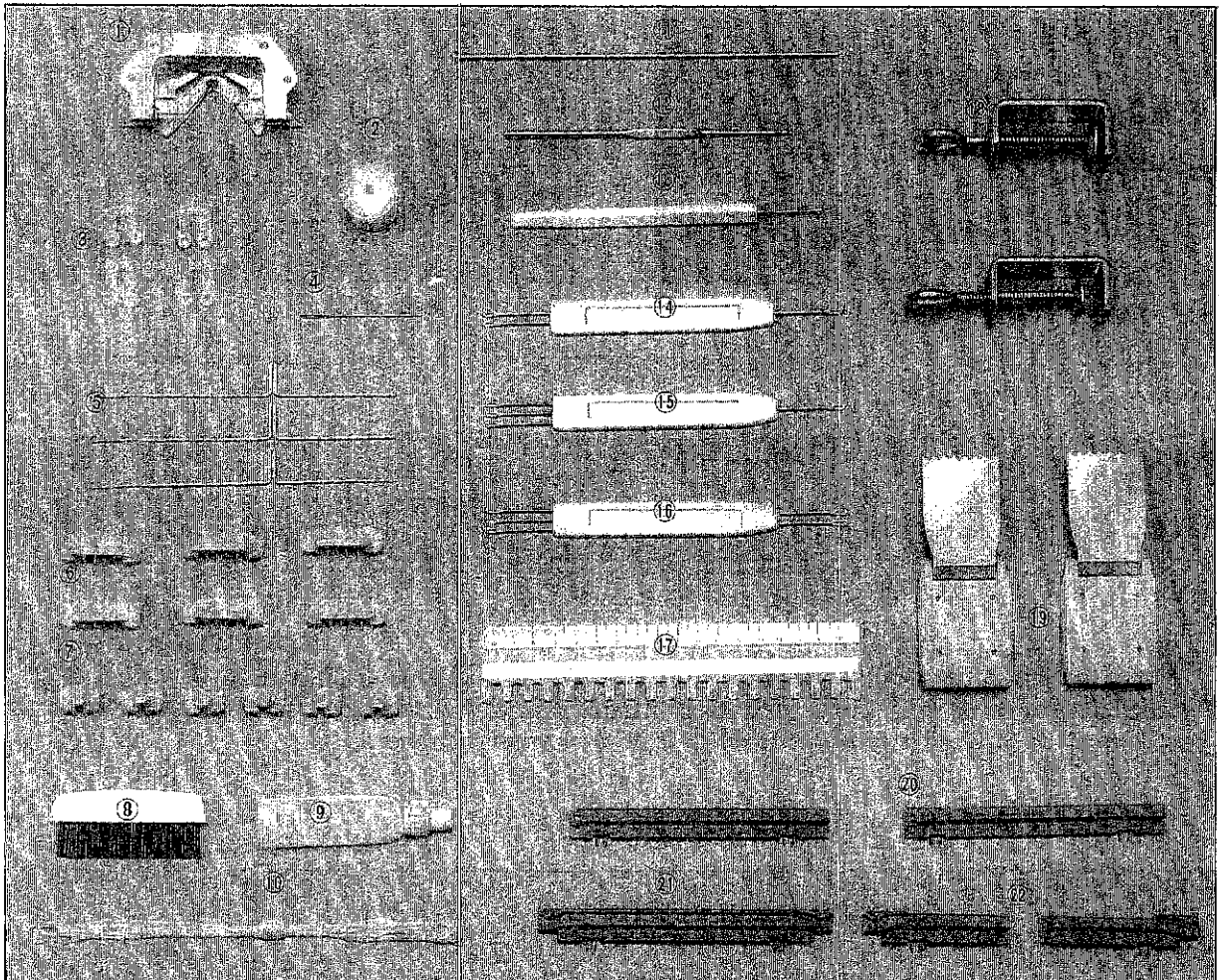

- | | | |
|--------------------------------------|------------------------------------|---------------------------------------|
| 1. Plating yarn feeder (1 pce.) | 9. Oil (1 pce.) | 17. 1/1 needle pusher (1 pce.) |
| 2. Yarn wax (1 pce.) | 10. Cast-on thread (1 pce.) | 18. Table clamps (2 pcs.) |
| 3. Snaps (4 pcs.) | 11. Punch card holder pin (1 pce.) | 19. Claw weights (2 pcs.) |
| 4. Tapestry needle (1 pce.) | 12. Crochet needle (1 pce.) | 20. Motif knitting cam M (2 pcs.) |
| 5. Spare needles (3 pcs.) | 13. Latch tool (1 pce.) | 21. One-point cam (1 pce.) |
| 6. L-point cam for 8-needle (6 pcs.) | 14. 1 x 2 Transfer tool (1 pce.) | 22. Motif knitting cam L & R (1 each) |
| 7. L-point cam for 4-needle (6 pcs.) | 15. 1 x 3 Transfer tool (1 pce.) | |
| 8. Hand brush (1 pce.) | 16. 2 x 3 Transfer tool (1 pce.) | |

1-2. REPLACING KNITTING MACHINE IN CARRYING CASE

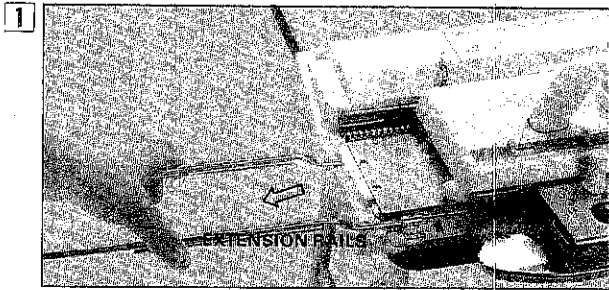

Remove the EXTENSION RAILS (lift up and pull).



Replace the L CARRIAGE in the carrying case.

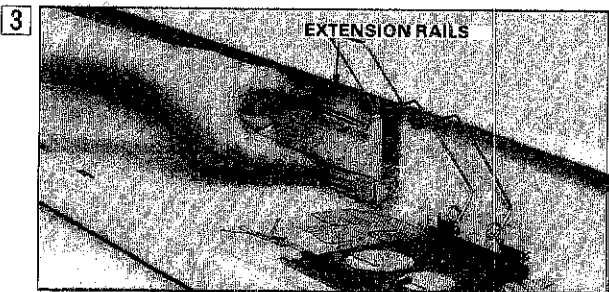

Replace the EXTENSION RAILS in the carrying case.

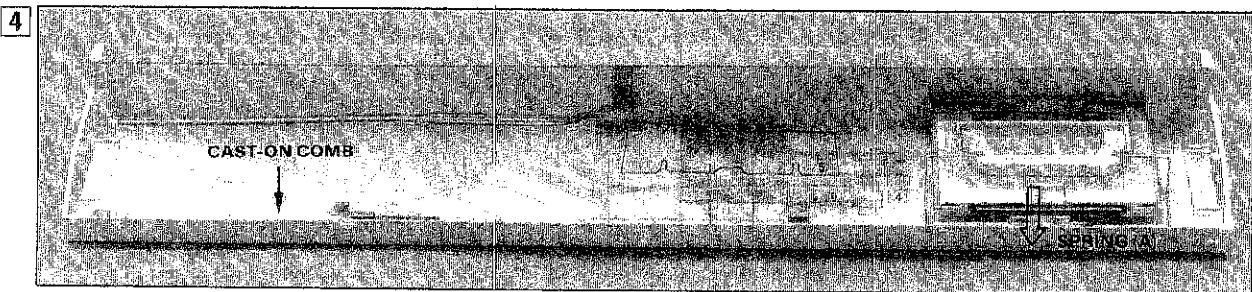

Replace the CAST-ON COMBS in the carrying case and set the SPRING to A position.

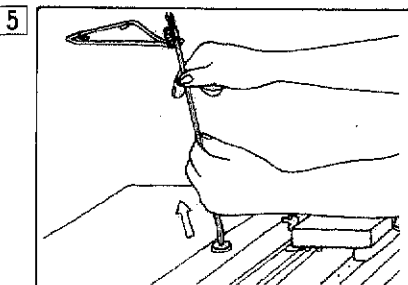

Pull up the YARN TENSION UNIT to remove.
Fold up the YARN TENSION UNIT in order as shown in the figures.

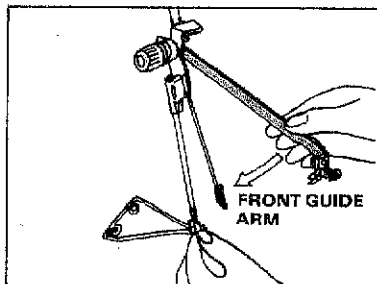

1) FRONT GUIDE ARM.

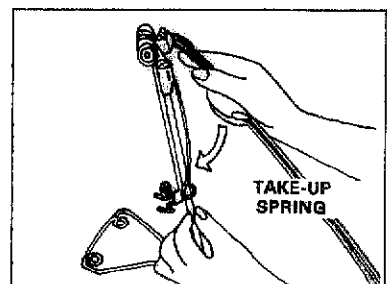

2) TAKE-UP SPRING.

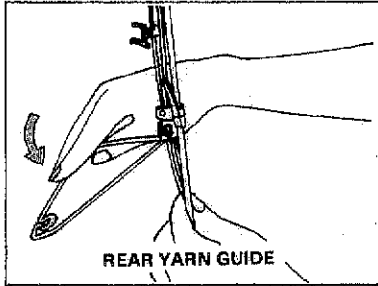

3) REAR YARN GUIDE.

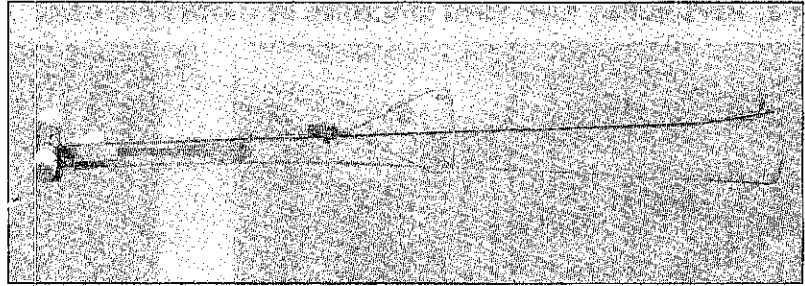

YARN TENSION UNIT.

6

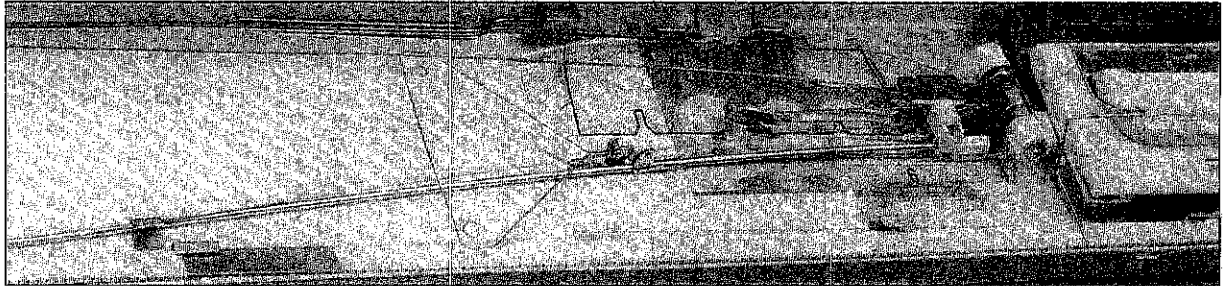

Replace the YARN TENSION UNIT in the carrying case.

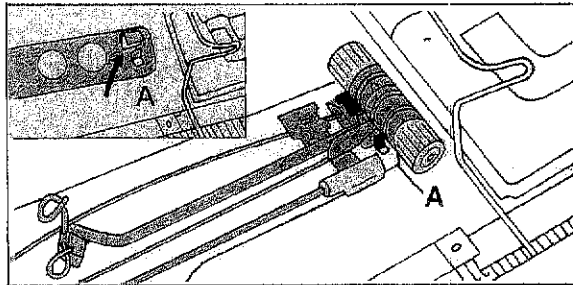

1) Place the head of YARN TENSION UNIT at the hook **A** as shown above.

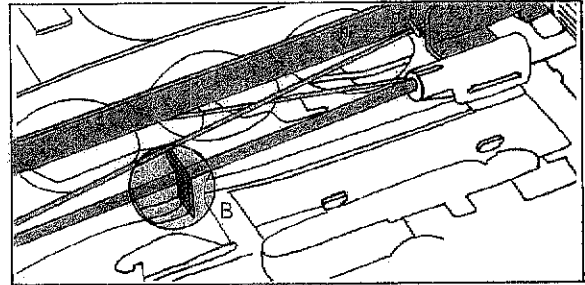

2) Set the YARN ROD on B position.

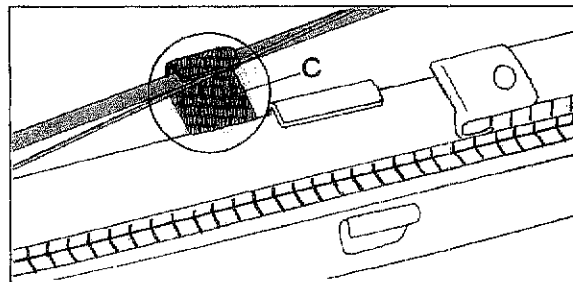

3) Set the YARN ROD and TAKE-UP SPRINGS on C position.

7

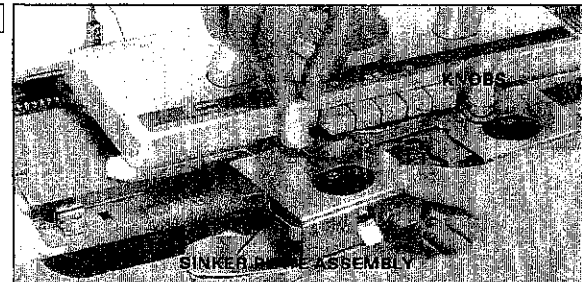

Loosen the KNOBS and remove the SINKER PLATE ASSEMBLY from the K carriage.

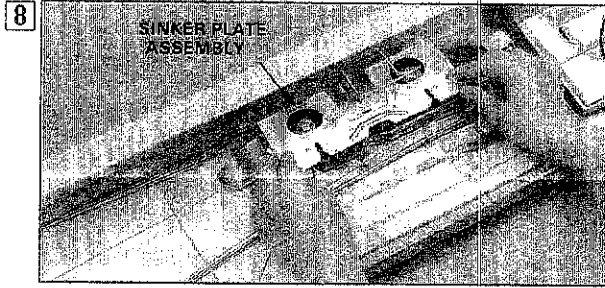

1) Replace it on the corresponding drawing in the carrying case.

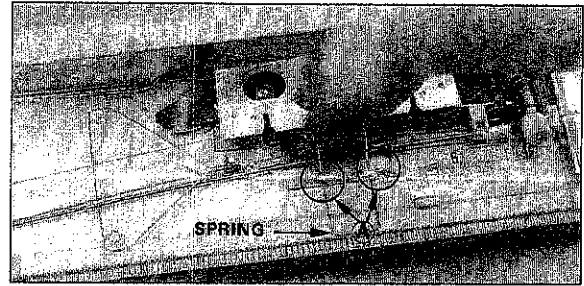

2) Set the SPRING to A position.

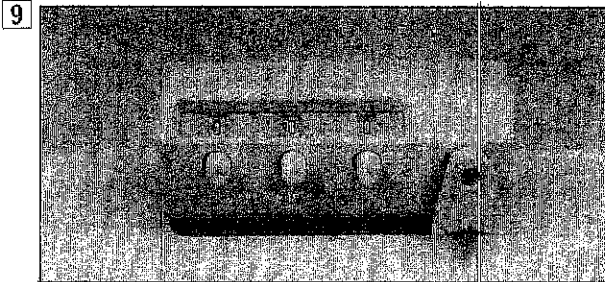

Remove the ROW COUNTER from the machine and replace it in the carrying case.

1) The figures on your ROW COUNTER can be moved to zero by turning the dials according to the arrows starting with the dial at the left.

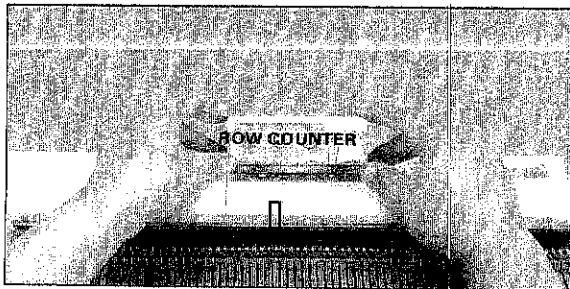

2) Pull the ROW COUNTER toward you and lift it up.

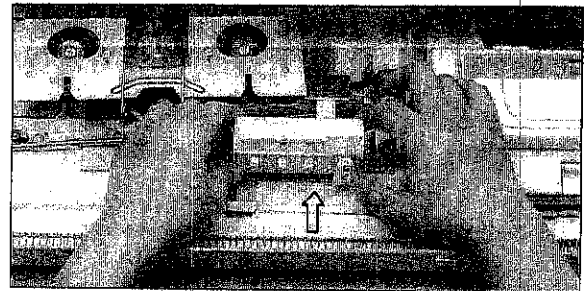

3) Set the ROW COUNTER onto the two studs in the carrying case and push it away from you.

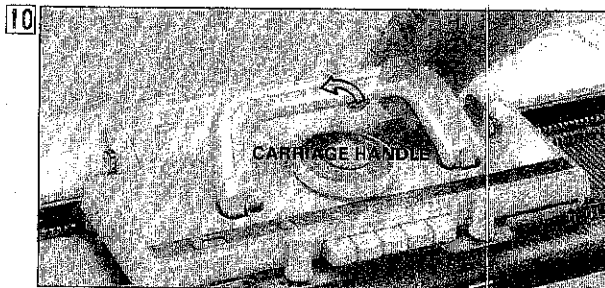

Fold down the CARRIAGE HANDLE.

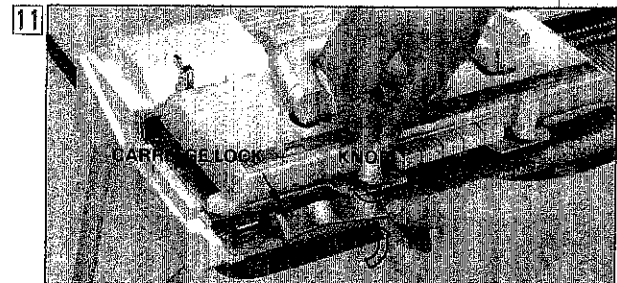

Insert the CARRIAGE LOCK in the hole at the left edge of the machine and lock the K CARRIAGE.

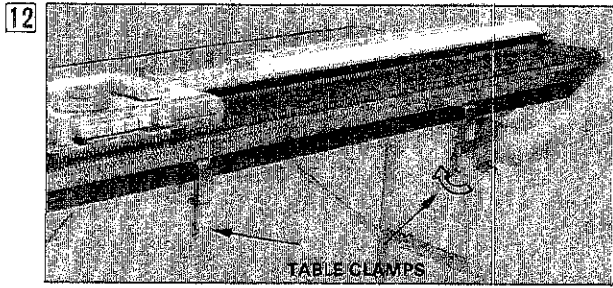

1) Release the two TABLE CLAMPS.

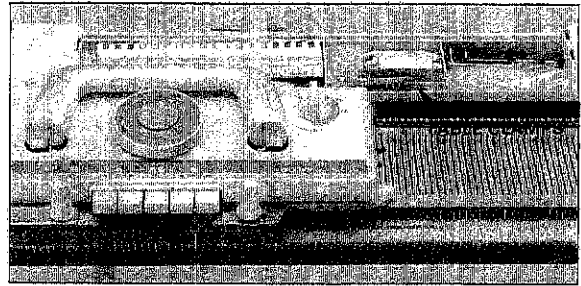

2) Replace the two TABLE CLAMPS in the accessory box.

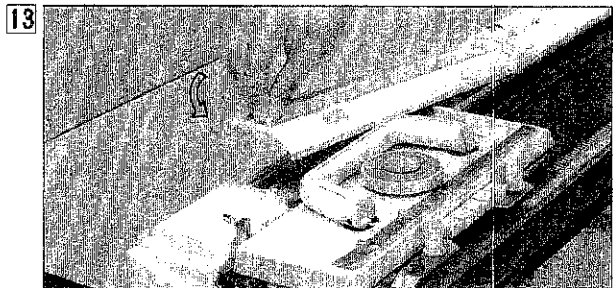

Replace the other accessories in the accessory box and close it. Push all needles back to position A.

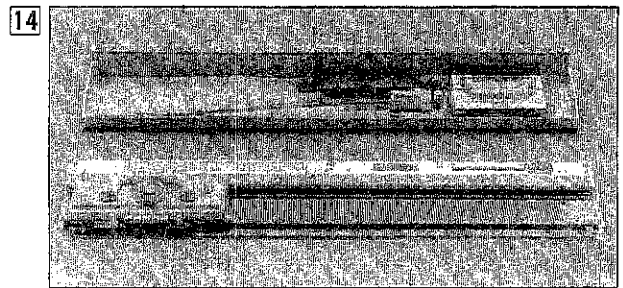

After replacing all the accessories.

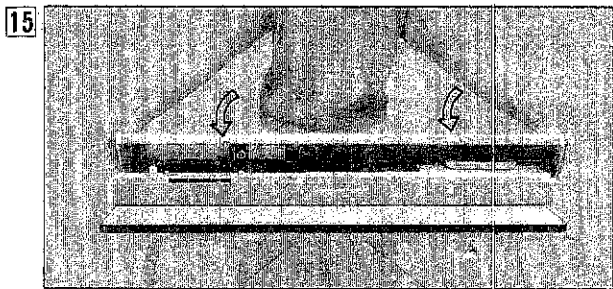

Hold the UPPER CASE and close the carrying case as shown in the figure.

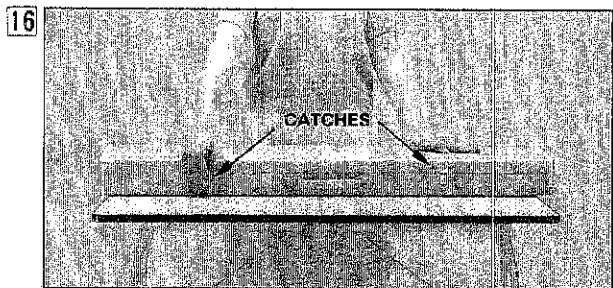
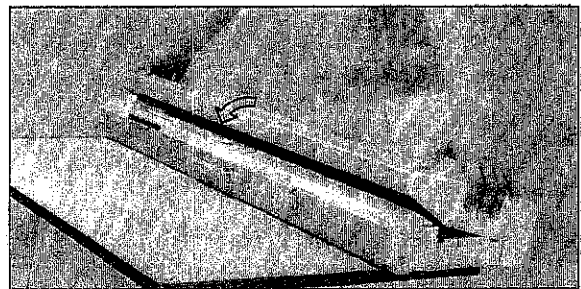

Lock the two CATCHES on either side of the handle.

2. HERE ARE A FEW IMPORTANT POINTS TO REMEMBER BEFORE YOU START KNITTING

2-1. PREPARATION OF YARN

For a beginner, it would be best to use new yarn.

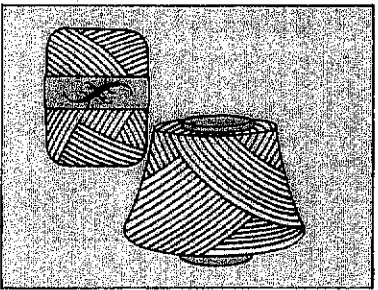
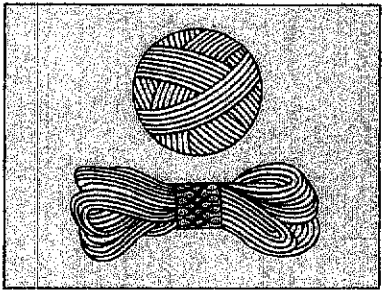

Rewind all yarn shown in the above illustration into a ball by using a SKEIN HOLDER and WOOL WINDER.

Yarn wound as shown in the above illustration can be used as they stand.

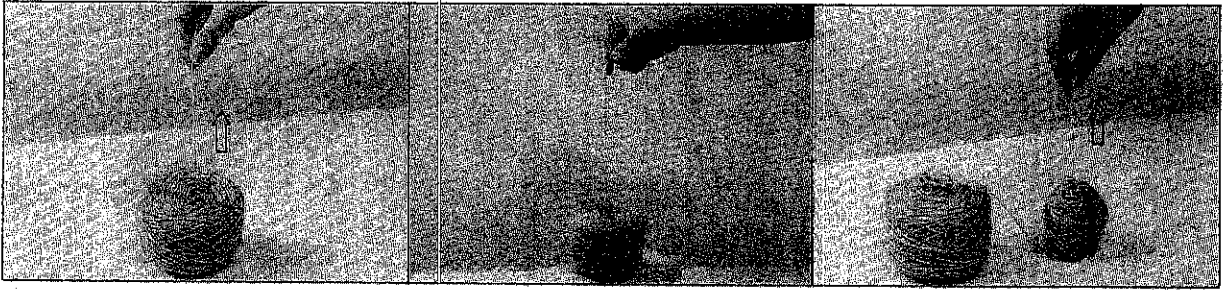
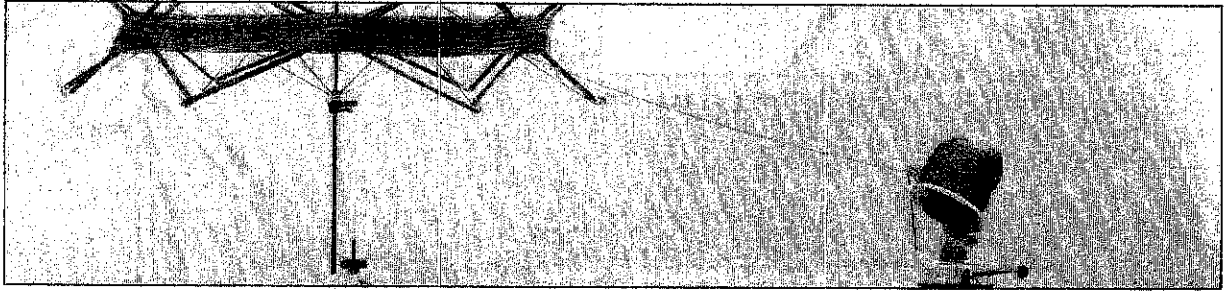

When the wound yarn is pulled from the center of the ball, it should come out freely without lifting the ball from the table.

If the yarn does not come out freely, pull some yarn out of the center of the ball.

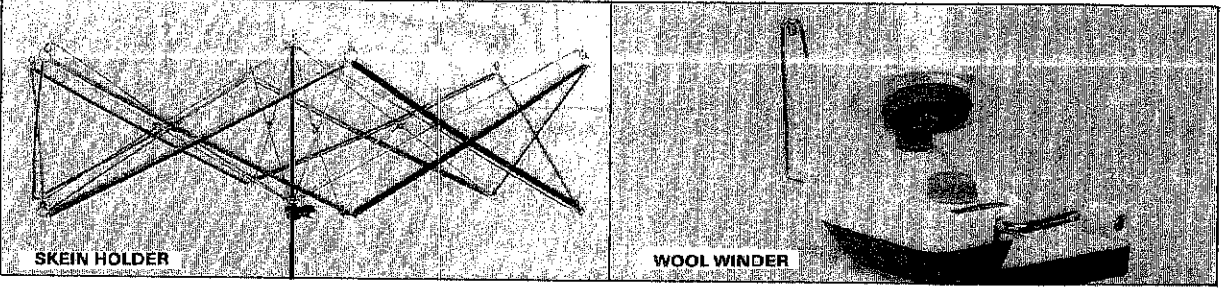

The SKEIN HOLDER and the WOOL WINDER are available separately.

2-2. THREADING THE YARN TENSION UNIT.

Thread the YARN TENSION UNIT in order as shown in the figure.

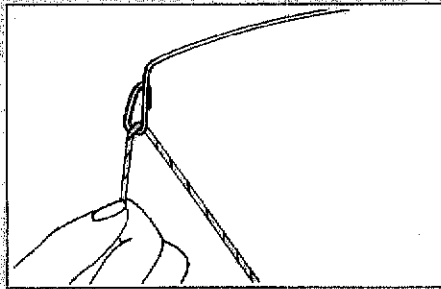

Thread the yarn into the EYELET OF THE TAKE-UP SPRING.

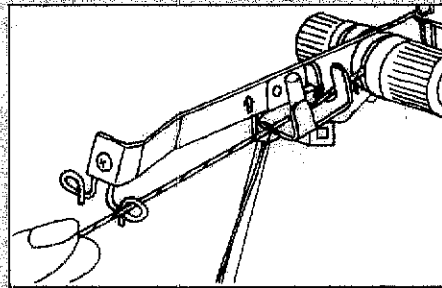

Thread the FRONT YARN GUIDE.

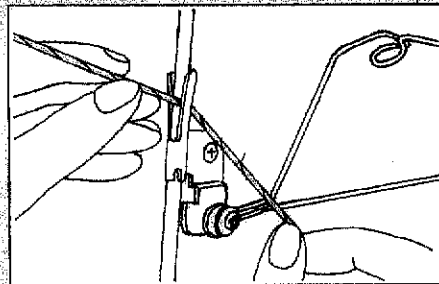

Clip the yarn under the YARN CLIP.

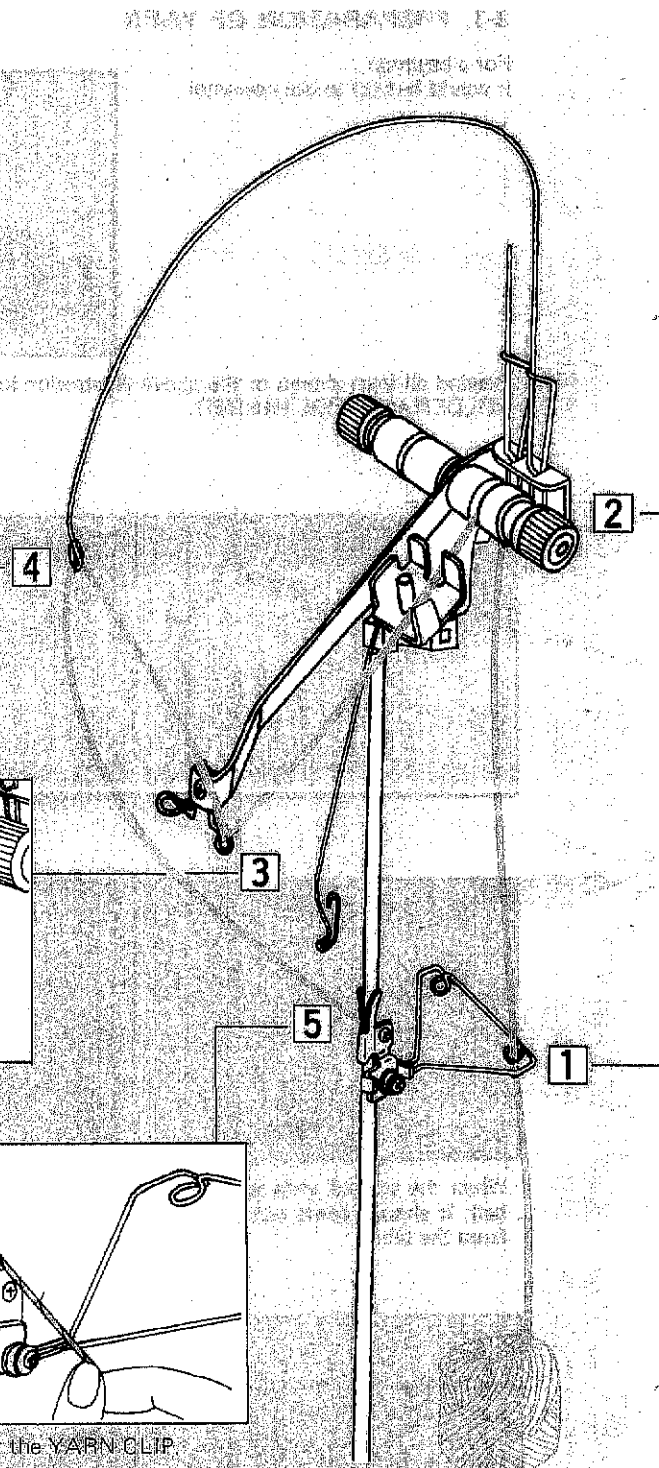

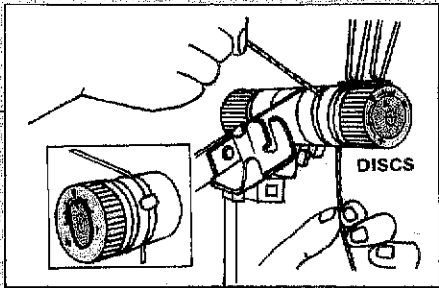

Pass the yarn under THE PIN and between the two DISCS from behind.
 (Hold the yarn as shown above and pull it towards you so that the yarn gets in under the PIN.)

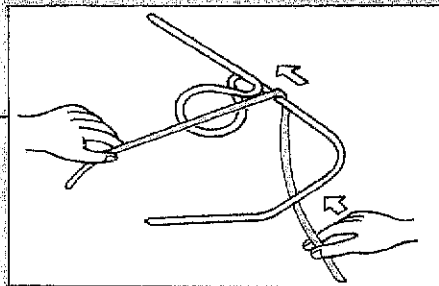

Pass the yarn from the ball through the REAR YARN GUIDE sliding the yarn through the eyelet.

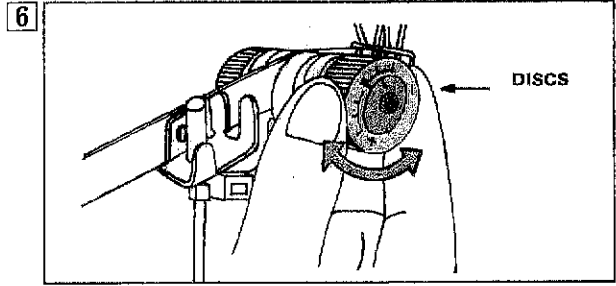
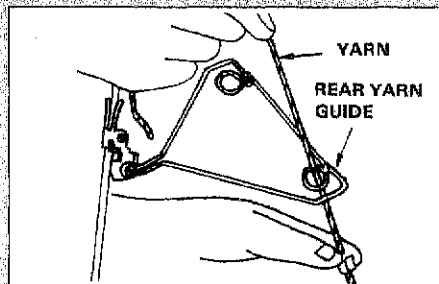

Set the arrow mark according to the thickness of yarn as below.

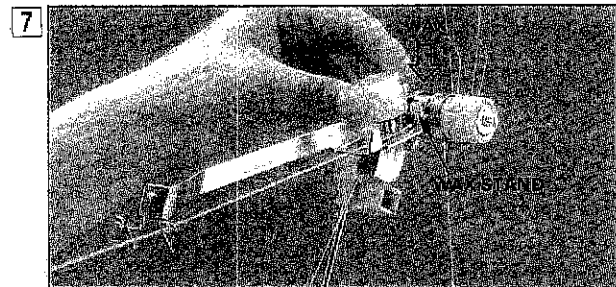
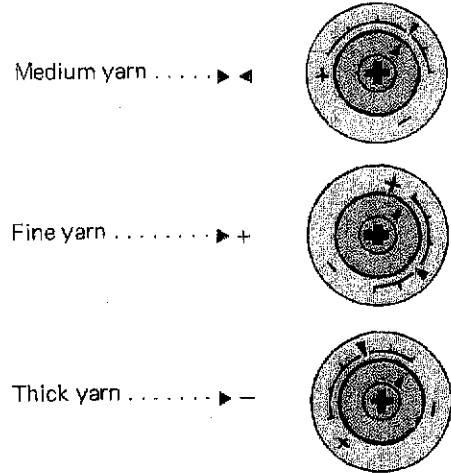

When you start knitting, set the WAX from the accessory box on the special stand.

The WAX will help the yarn to slide more smoothly.

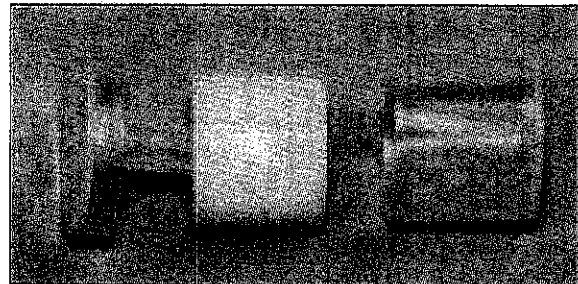

Wax with wax case.

2-3. NEEDLE POSITION

On either side of the needle bed there appears the marks A, B, D and E.

- A Non-working position.
- B Working position (Used for general work).
- D Pattern knitting position (Selected Needles are brought to this position by the K carriage).
- E Holding position (The stitch will 'Hold' on the needle until released. Used for shaping e.g. socks, necklines, darts.)

When you fold up the machine, return the needles to position A.

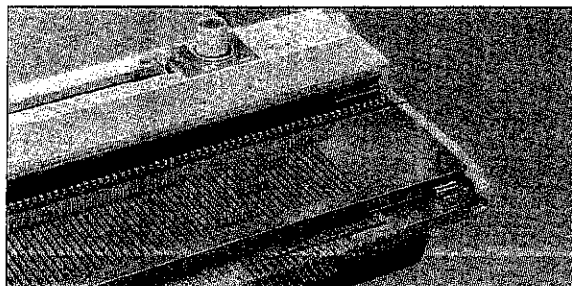

2-4. NAME OF PARTS . . . K CARRIAGE.

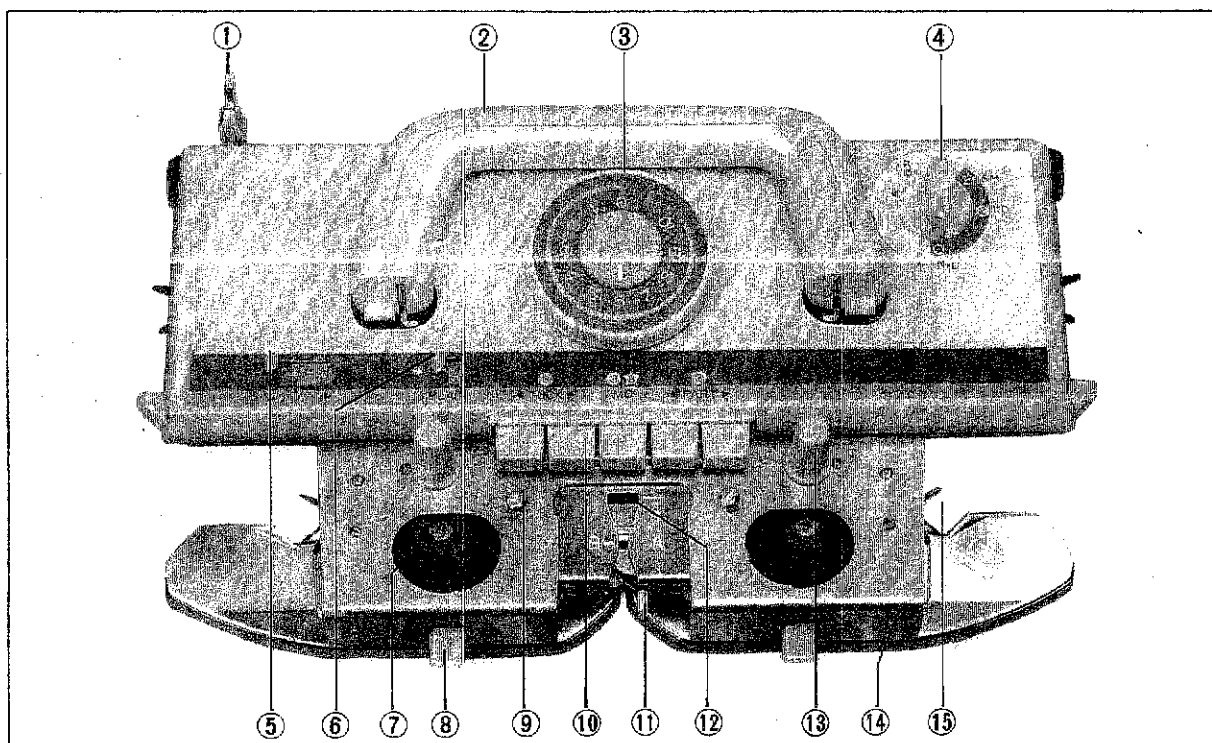

- | | | |
|------------------------|------------------------------|---------------------------|
| 1. Row counter tripper | 6. Cam button release lever | 11. Yarn feeder lever |
| 2. K carriage handle | 7. Weaving pattern brush | 12. Yarn feeder |
| 3. Tension dial | 8. Weaving pattern lever | 13. Knobs |
| 4. Change knob | 9. Yarn feeder setting screw | 14. Sinker plate assembly |
| 5. Holding cam lever | 10. Cam buttons | 15. Weaving yarn guide |

2-5. RELATION BETWEEN THE TENSION DIAL AND YARN

1 TENSION DIAL

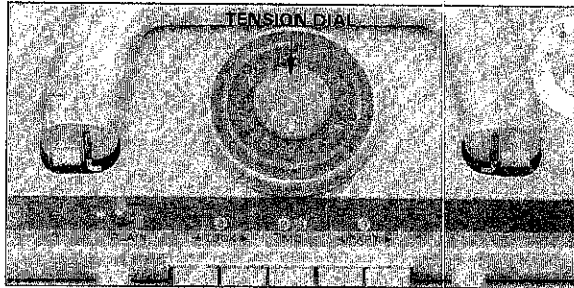

This dial is graduated from 0 to 10, each space being subdivided into three parts.

The size of stitch is adjusted by the tension setting on the Carriage Tension Dial. 0 denotes the tightest tension (i.e. the smallest stitch) and 10 is the loosest tension (i.e. the largest stitch).

Adjust the dial according to the thickness of the yarn.

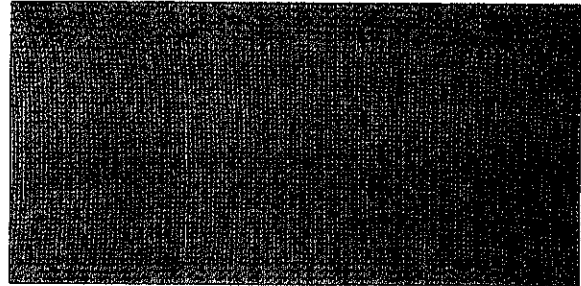

1) TENSION DIAL is tight.







2) TENSION DIAL is loose.

2 YARN

There are too many types of yarn to show all of them here and each type of yarn requires its own Tension Dial (T.D.) number.

Find the proper Tension Dial (T.D.) number by referring to the following table.

Type of yarn		Recommended T.D. number	
1.		Very fine yarn	1 ~ 3
2.		Fine yarn	3 ~ 5
3.		Medium yarn	5 ~ 7
4.		Thick yarn	7 ~ 9
5.		Very thick yarn	8 ~ 10

Remarks: For very thick or bulky yarn, use every other or every third needle.

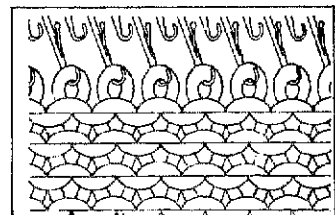

3. BASIC OPERATION PRACTICE I (PLAIN KNITTING)

3-1. PLAIN KNITTING.

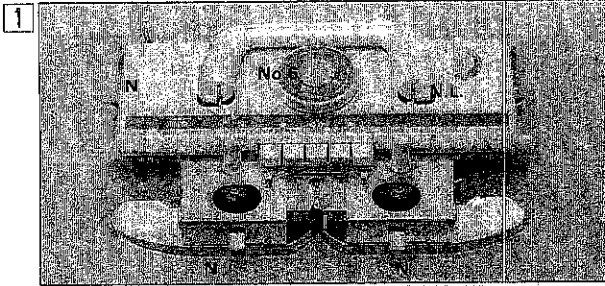

1 Set the K CARRIAGE.
(The following instructions are explained based on Tension dial number 6.)

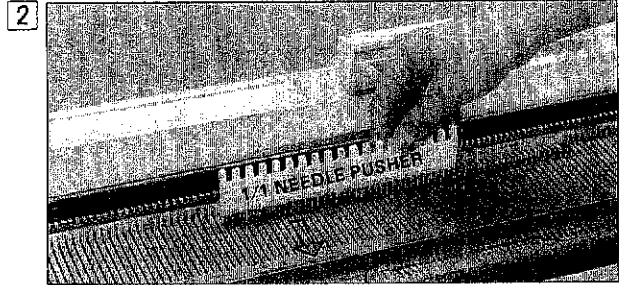

2 Using the 1/1 NEEDLE PUSHER bring forward 60 needles to position B. (30 needles on either side of the center mark "0".)

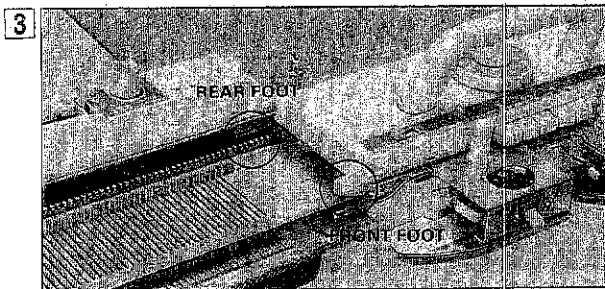

3 After seeing that the REAR and FRONT FEET of the K CARRIAGE are set on the NEEDLE BED correctly, move the K CARRIAGE across and back to straighten these needles into position B.

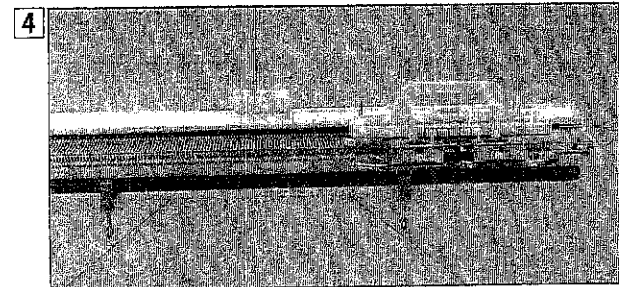

4 Place the K CARRIAGE at right side of the machine.

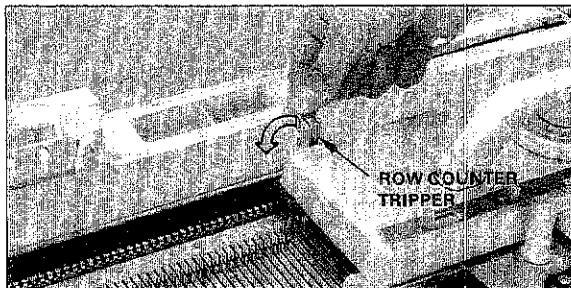

When using the ROW COUNTER, set the ROW COUNTER TRIPPER to working position.

5

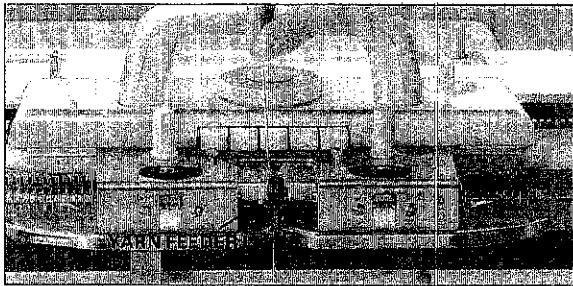

Turn the YARN FEEDER LEVER to the left and take the end of the yarn (which has been clipped onto the YARN TENSION ROD). Thread it into the YARN FEEDER "A" for main yarn. Hold the yarn from below with your left hand and from above with your right. Then put the yarn into the YARN FEEDER "A".

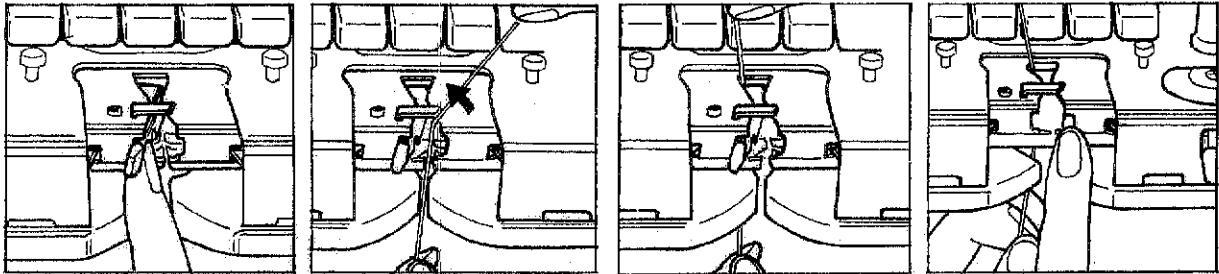

Hold the end of the yarn with your left hand under the YARN FEEDER "A". Close the YARN LEVER.

6

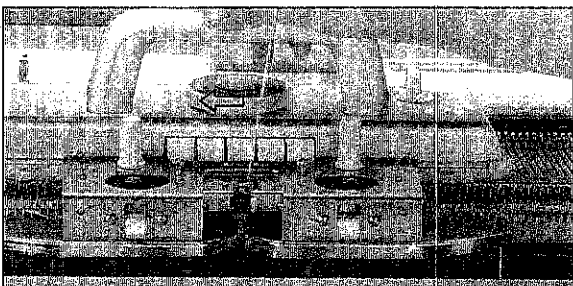

Move the K CARRIAGE to the left, holding the end of the yarn with your left hand. (When moving the K CARRIAGE, keep your left hand at the right edge of the knitting.)

7

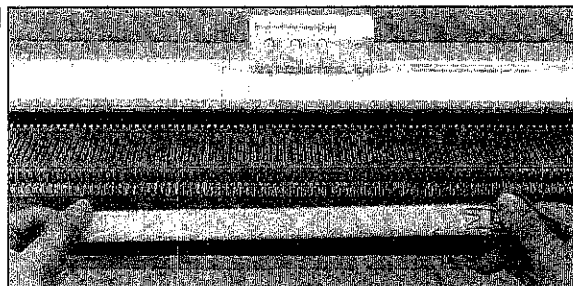

Hang the CAST-ON COMB.

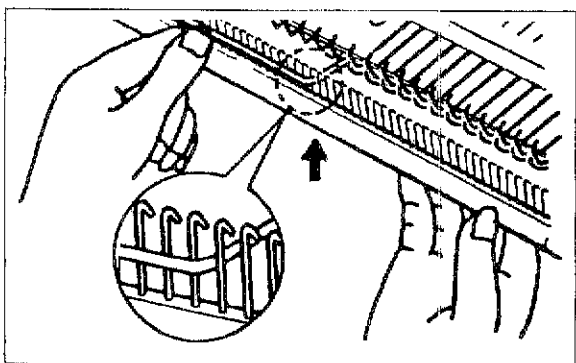

The edge of hook faces the machine as shown in the figure.
Pull the yarn of carriage side toward you and hang the Cast-on Comb on the stitch as shown in the figure.

How to use the Cast-on Comb

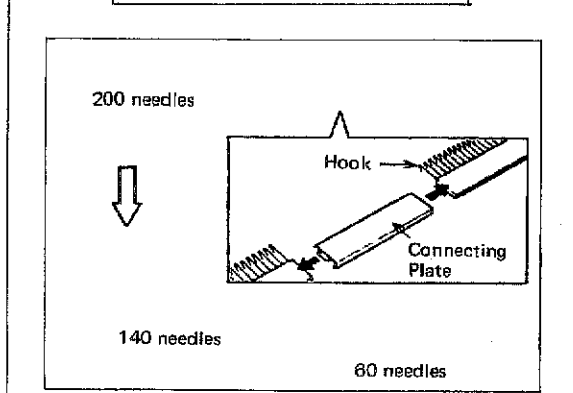

Using by connecting Plate, you can use Cast-on Comb properly for 60 needles, 140 needles or 200 needles.

8

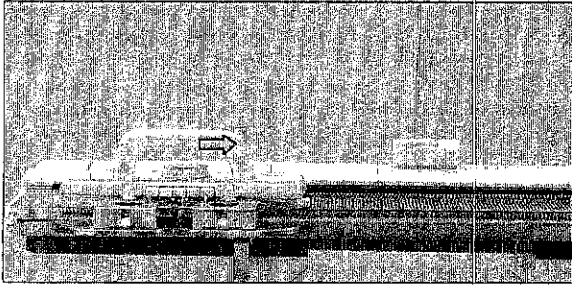

Move the K CARRIAGE to the right slowly.

9

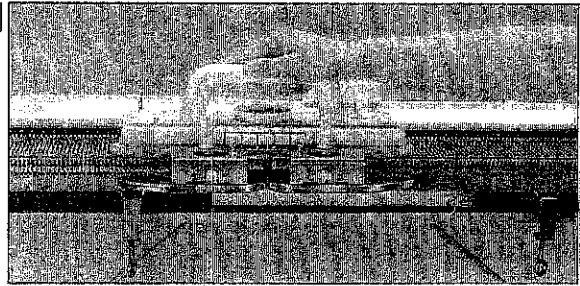

Always move the K CARRIAGE across until you hear the "CLICK" at the end of a row. Continue knitting each row at the same speed. Continue to operate the K CARRIAGE back and forth. This is called PLAIN KNITTING.

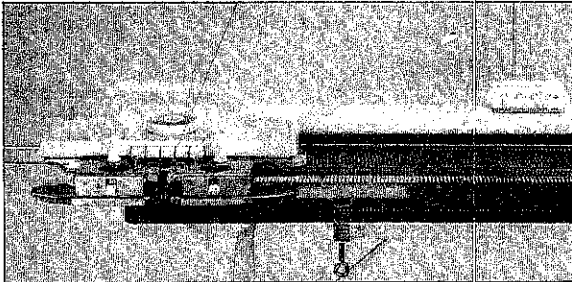

Do not move K CARRIAGE too far beyond the knitting, and do not reverse K CARRIAGE in the middle of a row.

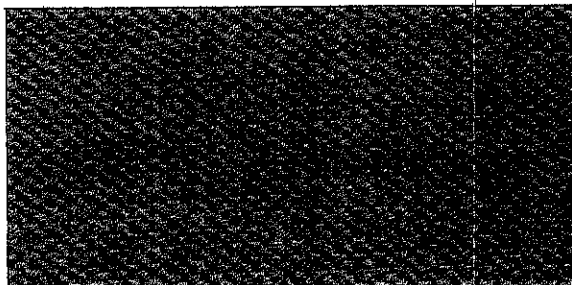
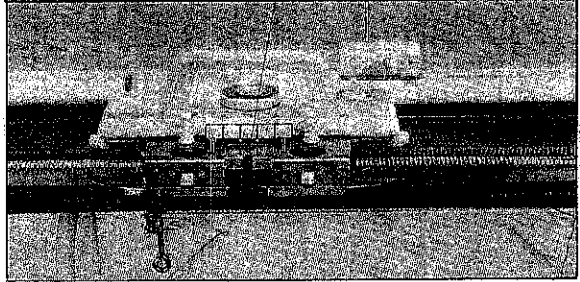

The purl side.
When knitting, this side is facing you.

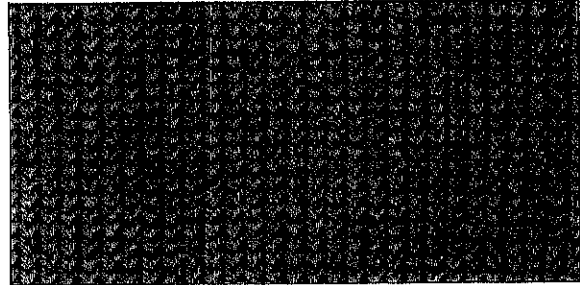

The plain side.
When knitting, this side is away from you.

3-2. HOW TO REMOVE THE KNITTING FROM THE MACHINE.

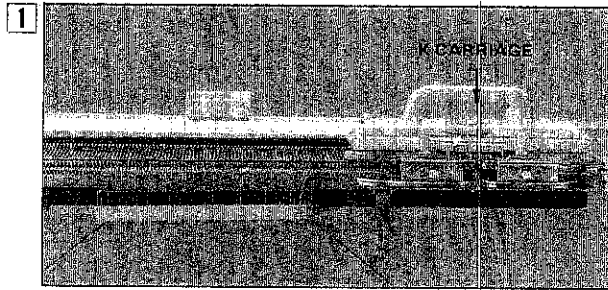

Place the K CARRIAGE on the right side.

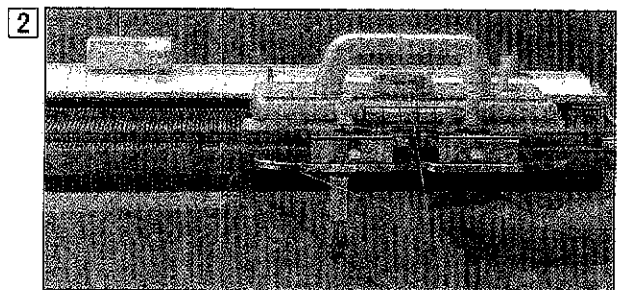

Take the yarn out of the YARN FEEDER "A".

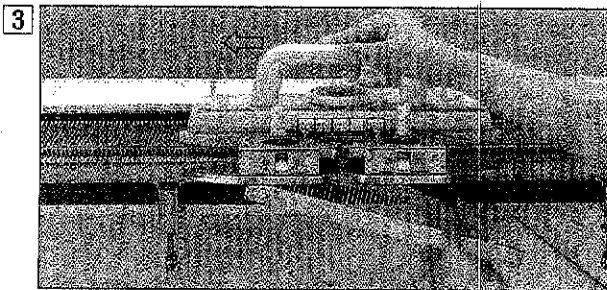

Move the K CARRIAGE to left holding the knitting.
The knitting will be removed from the machine.

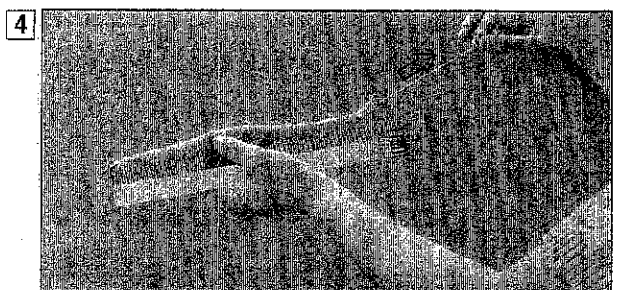

As the knitting is not finished off, it will unravel easily.

**Plain knitting is the basic way to knit.
Practice until you can do it smoothly
from the beginning.**

3-3. HOW TO CAST ON WITH A FINISHED EDGE

3-3-1. Using Hand Method

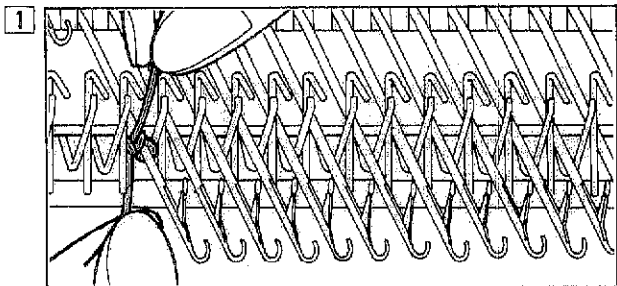

1) Make a loop and fasten the end of the yarn threaded through the YARN TENSION UNIT onto the end needle on the left.

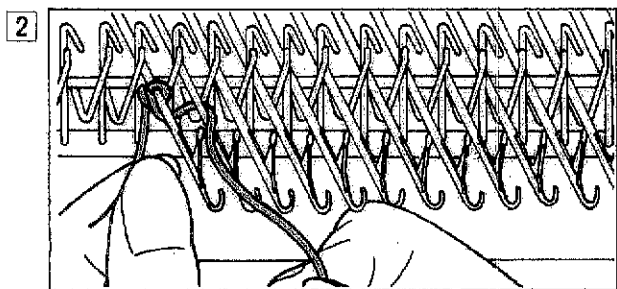

1) Loop the yarn around the second needle from left, counterclockwise.

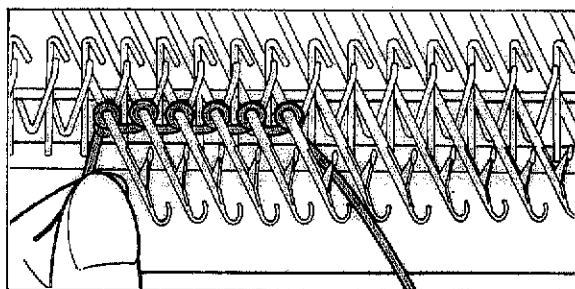

2) Loop the yarn around each needle from left to right in the same way.

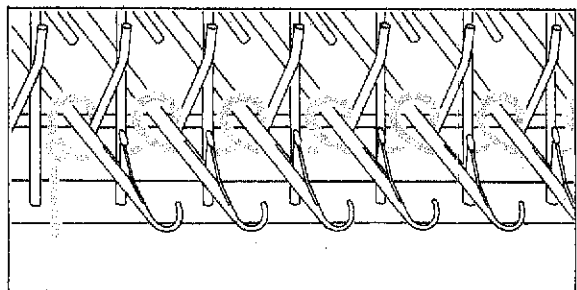

3) The loops must be pushed back on the stems of the needles. Do not make the loops too tight.

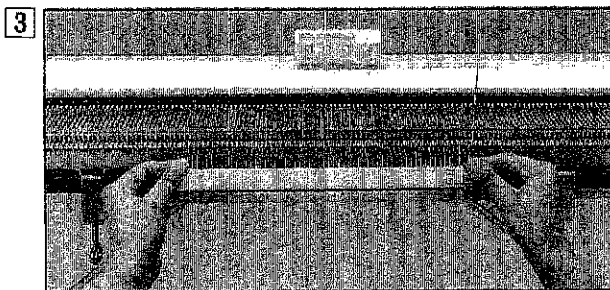

Hang the CAST-ON COMB.

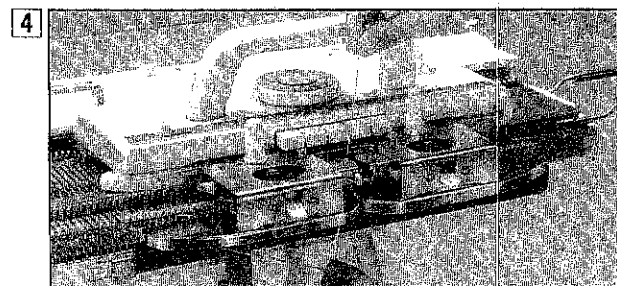

4) After looping the yarn around each needle, thread the yarn into the yarn feeder "A".

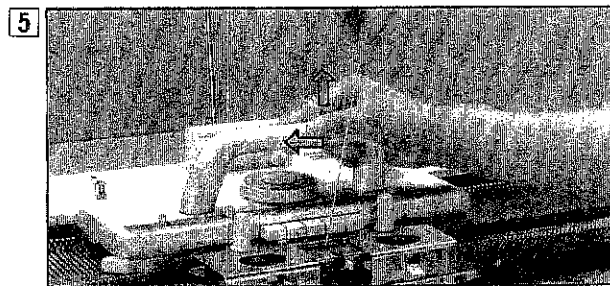

5) Move the K CARRIAGE from right to left lifting the yarn up slightly.

3-3-2. Using Latch Tool Method

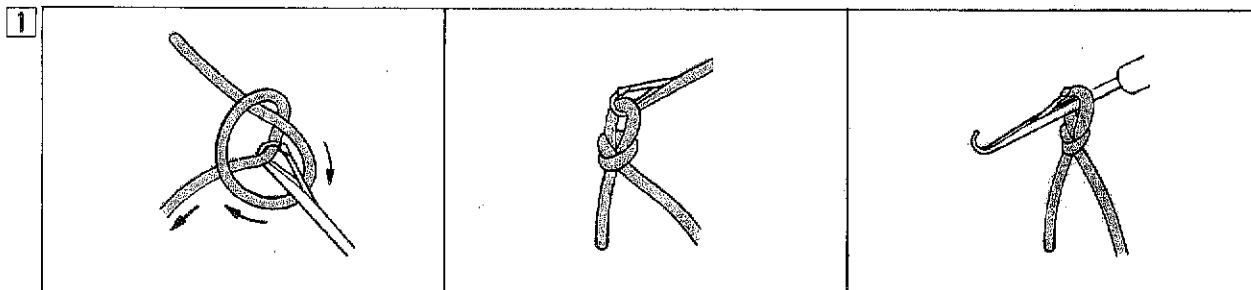

Make the chain stitch by using the latch tool.

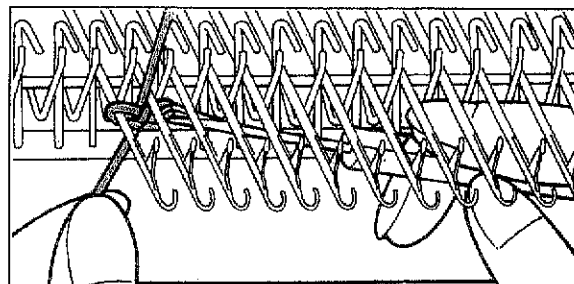
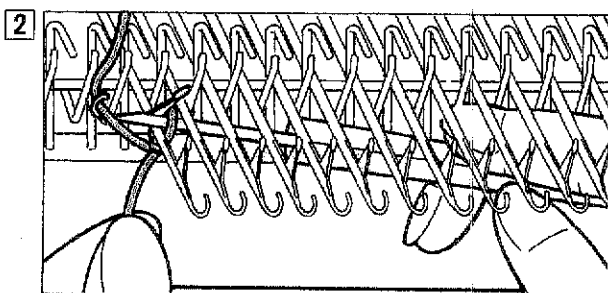

With the loop behind the latch, put the LATCH TOOL between the left edge needle and the second needle and make a stitch.

2) Pull the LATCH TOOL through the loop on the stem of the latch tool. This makes a stitch.

1) Push the LATCH TOOL up and hook the yarn.

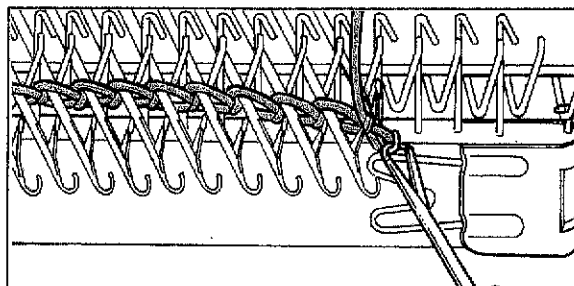
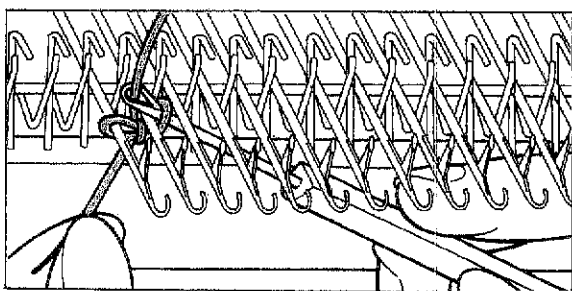

3) Repeat this, and when you get to the right, do not make a stitch. Transfer the yarn to the needle hook.

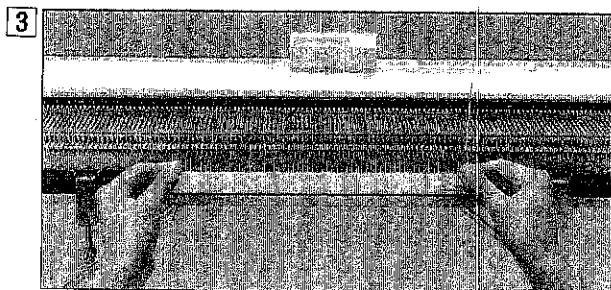

Hang the CAST-ON COMB.

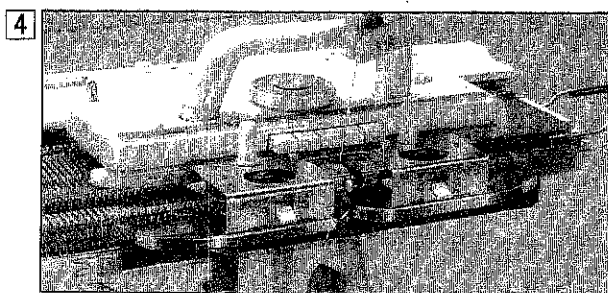

Thread the yarn into the YARN FEEDER "A".

5

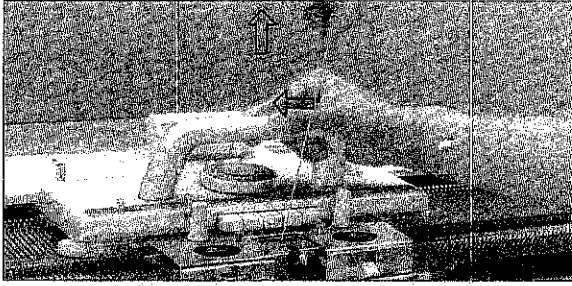

Move the K CARRIAGE to the left lifting the yarn up slightly.

3-3-3. Using the Weaving Pattern Lever and 1/1 Needle Pusher

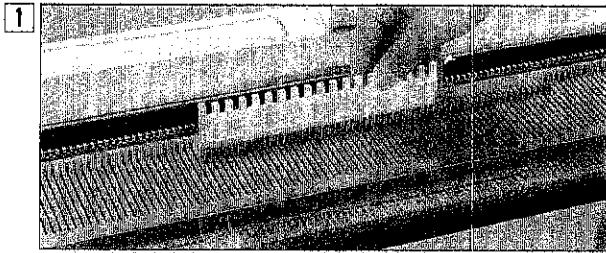

1 Bring forward the required needles to position B.

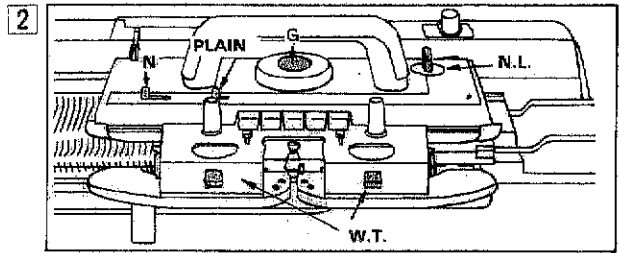

2 Set the K CARRIAGE as shown in the figure and place it on the right side of the machine.

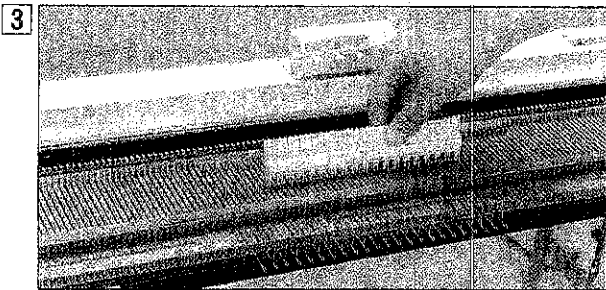

3 Using 1/1 NEEDLE PUSHER, bring forward every other needle to position E.

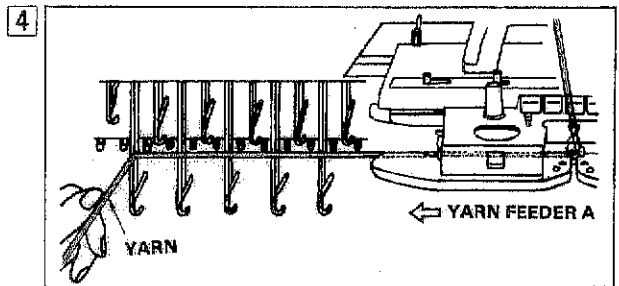

4 Thread the yarn into the yarn feeder "A". Holding the end of the yarn with your left hand, lay the yarn over the selected needles as shown. Hold the end of the yarn as shown in the figure.

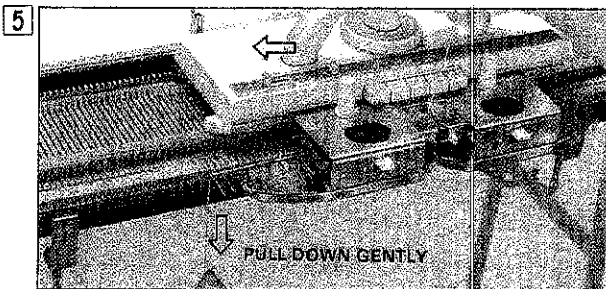

5 Pulling the yarn down gently with the left hand, move the K CARRIAGE to knit slowly with right hand. Continue to hold the end of yarn with left hand for few rows.

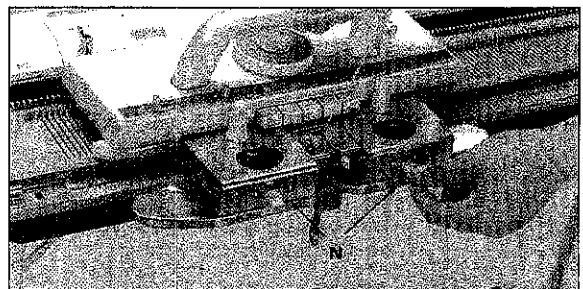

6 Return the Weaving pattern levers to N, and release yarn which was held in left hand.

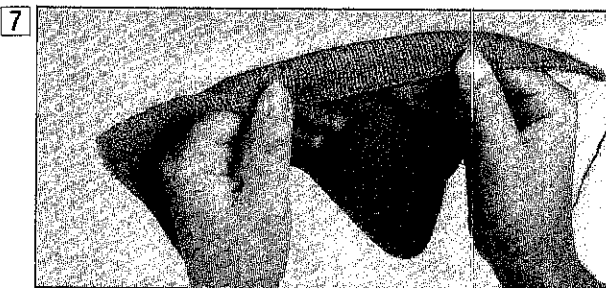

7 Now you can make plain knitting with finished edge.

4. KNOWLEDGE OF PLAIN KNITTING

4-1. WHEN YOU CANNOT CAST ON

4-1-1. When the Needles Do Not Catch the Yarn

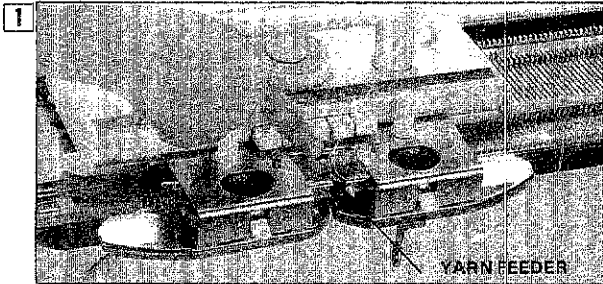

Make sure that the yarn is in the YARN FEEDER "A", you will be unable to knit unless it is.

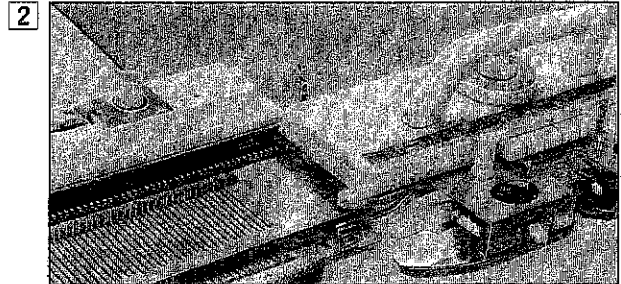

Make sure that the K CARRIAGE is set on the needle bed correctly.

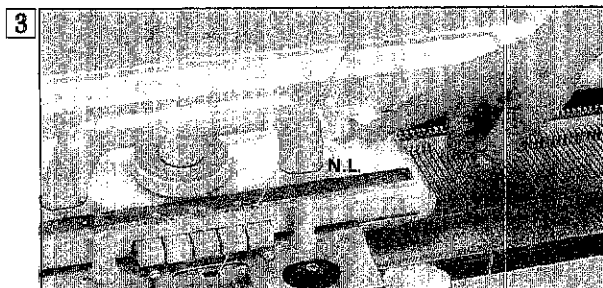

Make sure that the CHANGE KNOB is set to position N-L.



Make sure that the SINKER PLATE ASSEMBLY is set on the K CARRIAGE correctly.

4-2. WHEN THE K CARRIAGE IS HARD TO PUSH BACK AND FORTH

Make sure that the TENSION DIAL and DISCS are adjusted according to the thickness of the yarn. We cannot show you which tension dial number you should use, because there are various kinds of yarn.

Find the proper number yourself by referring to the table.

Type of yarn	Tension dial	Tension disc
Fine yarn	1 ~ 5	▶+
Medium yarn	5 ~ 7	▶◀
Thick yarn	7 ~ 10	▶-

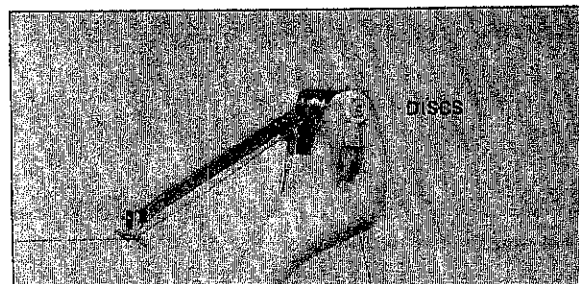

Comparison of the knitting.

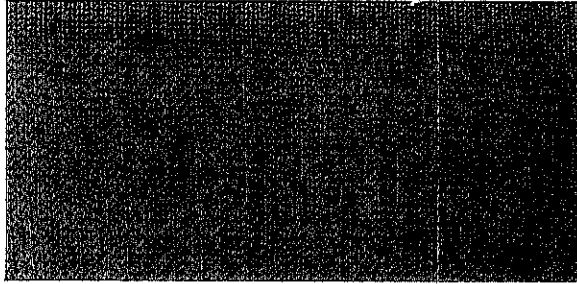

1) TENSION DIAL is tight.

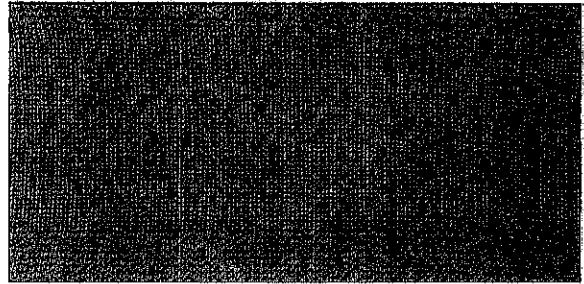

2) TENSION DIAL is loose.

- 1 When the stitches are too tight or too loose, adjust the TENSION DIAL to a higher or lower number and get the correct stitch size.
- 2 Make sure that you thread the yarn into the YARN TENSION UNIT correctly and that the yarn comes out smoothly.
- 3 Make sure that the machine is in good condition. If the machine requires oiling or is dirty, see on page 107.
- 4 Make sure that the WHEEL BRUSHES turn freely. If they don't, see on page 30- 3.

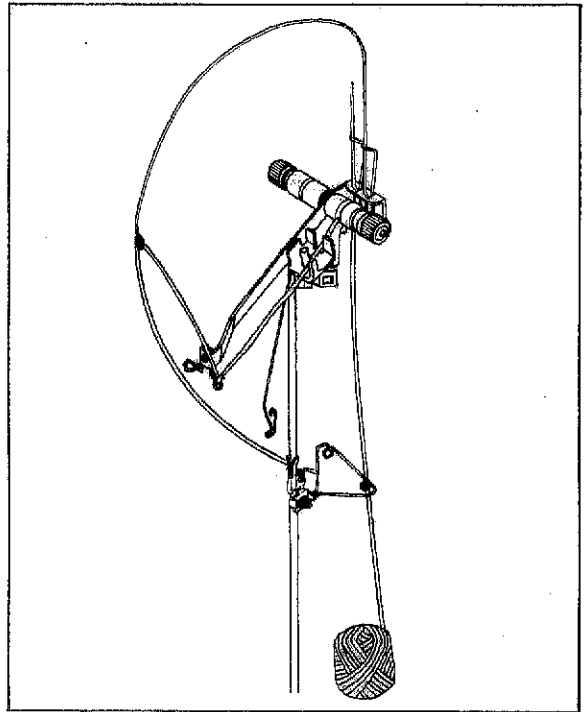

4.3. IF THE K CARRIAGE SHOULD JAM

Do not move the K CARRIAGE by force. Remove the K CARRIAGE and start knitting again from the beginning of the row.

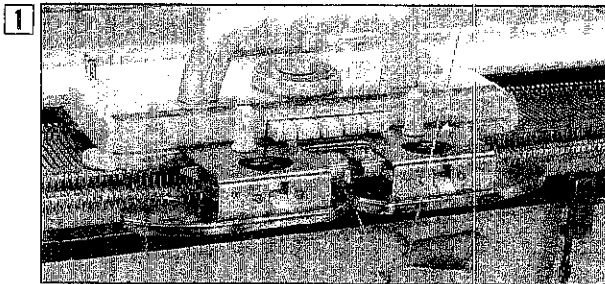

1 Take the yarn out of the YARN FEEDER "A".

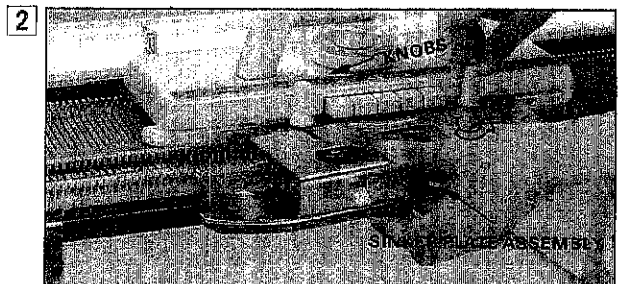

2 Loosen the KNOBS and remove the SINKER PLATE ASSEMBLY from the K CARRIAGE.

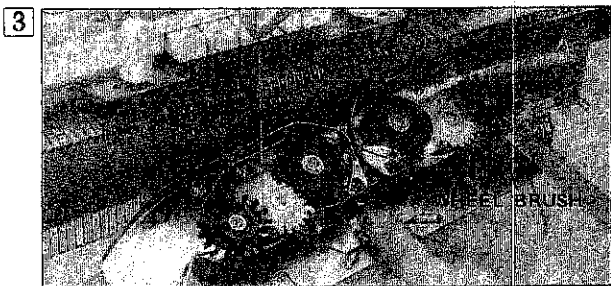

3 Turn over the SINKER PLATE ASSEMBLY. If the yarn has wrapped around the WHEEL BRUSH, remove it from the BRUSH.

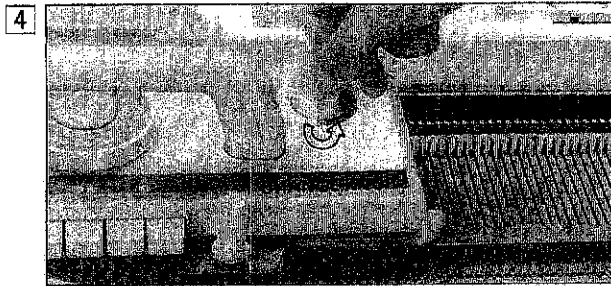

4 Set the CHANGE KNOB to position CR. This will release the K CARRIAGE.

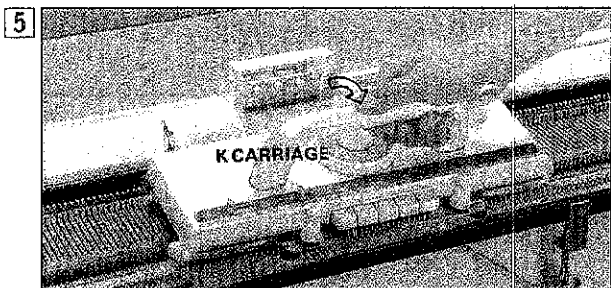

5 Lift the K CARRIAGE up toward you to remove it.

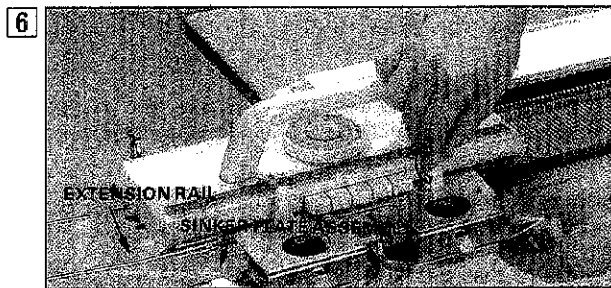

6 Place the K CARRIAGE on the EXTENSION RAIL and set the SINKER PLATE ASSEMBLY on the K carriage.



7 Return the CHANGE KNOB to position N-L.

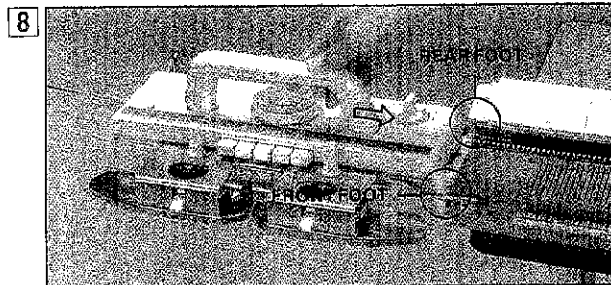

8 Make certain the K CARRIAGE is set on the NEEDLE BED correctly.

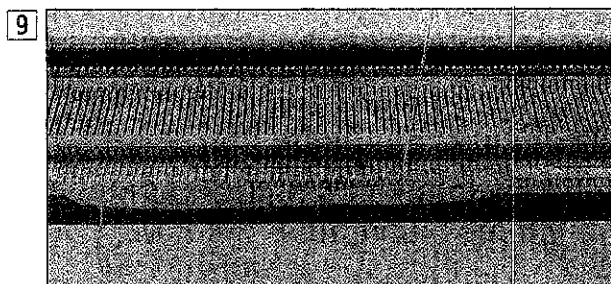

9 Unravel a row of knitting.

1) Using a TRANSFER TOOL transfer each stitch on the stem of a needle to the hook of the needle so that the stitches will not drop off. (This method is illustrated in the following four (4) steps.)

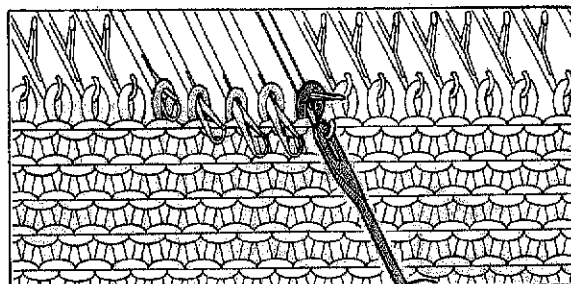

2) Place the EYE of the TRANSFER TOOL onto the hook of the needle.

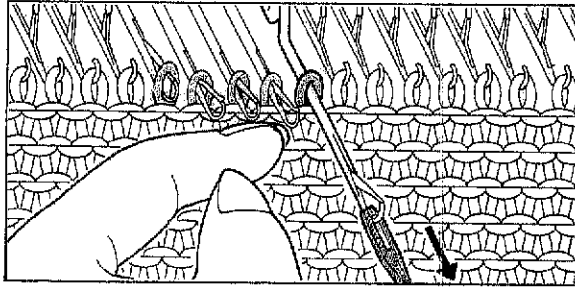

3) Hold the TRANSFER TOOL parallel with the needle and pull it toward you.

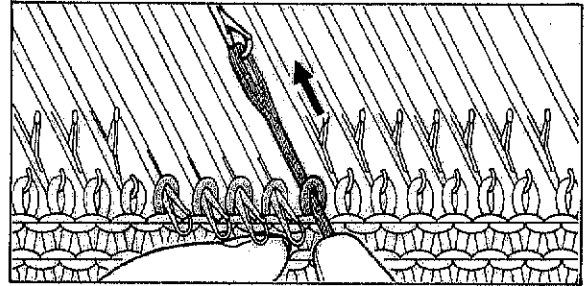

4) Push the TRANSFER TOOL toward the machine until the stitch is on the transfer tool.

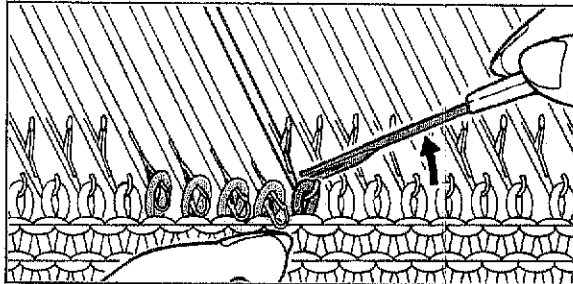

5) Transfer the stitch on the TRANSFER TOOL to the HOOK of the needle.

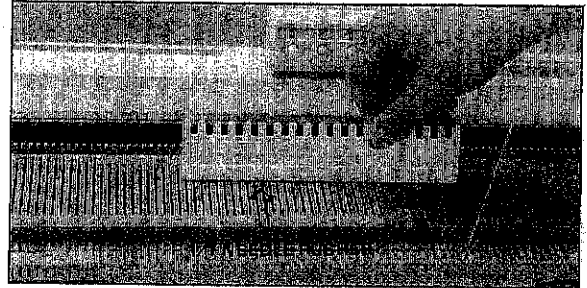

6) After transferring each stitch to the hook of a needle, bring back all the needles to position B by using the 1/1 NEEDLE PUSHER.

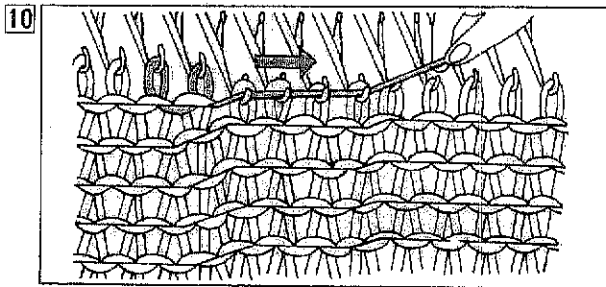

Unravelling a row of the knitting.

- 1) Hold the yarn parallel with GATE PEGS.
- 2) Pull the yarn slightly sideways.

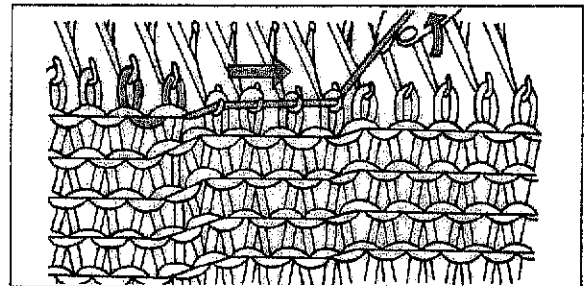

Pull and up to unravel the knitting.

The stitches will come off the needles and the stitches from the row below will slip onto the needle.

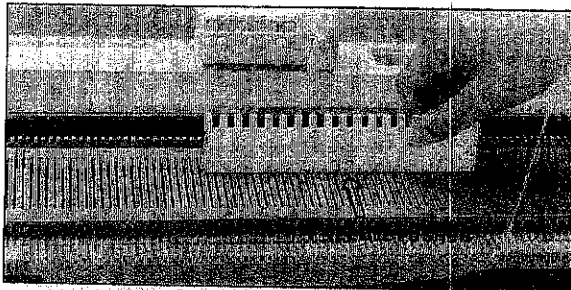

3) After unravelling the knitting, make sure that the stitches are in the hooks of the needles. Using the 1/1 NEEDLE PUSHER, return the needles to position B.

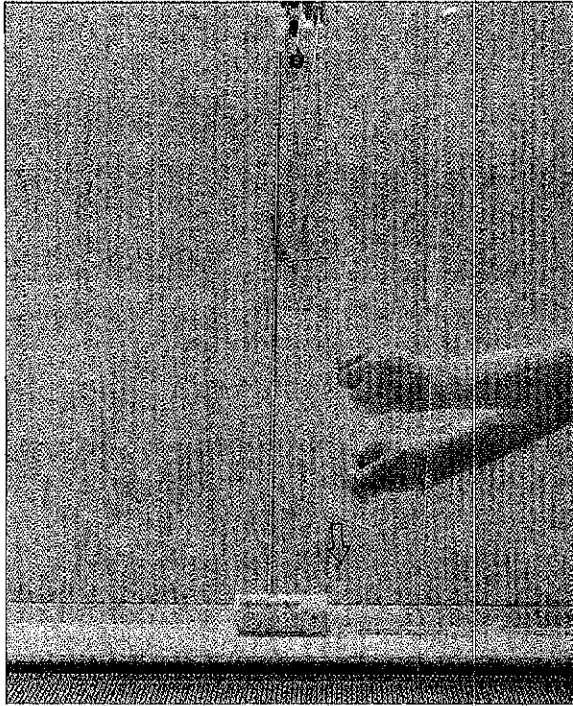

- 4) Pull the unravelled yarn down from behind the REAR YARN GUIDE to take up the slack. When unravelling several rows of knitting, repeat steps 1)-4). Unravel the knitting as the yarn comes toward K CARRIAGE side.

II Start knitting again.

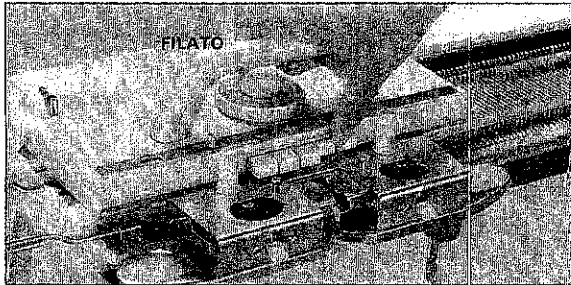

- 1) If the yarn is now on the opposite side of the knitting from the K CARRIAGE, you may move the K CARRIAGE across the needles without knitting by pressing both "PART" buttons and setting the H.C.L. to H. Make certain that all needles are in position B before going across with the K CARRIAGE.

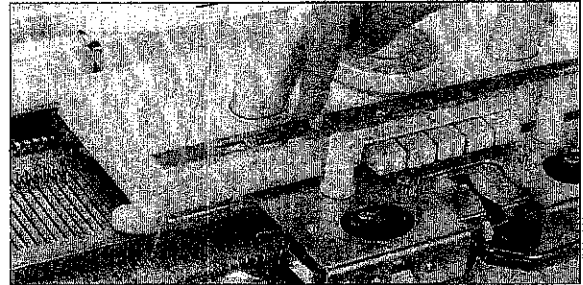

- After moving the K CARRIAGE to the other side, cancel both "PART" buttons by pressing the CAM BUTTON RELEASE LEVER and set the H.C.L. lever back to N.

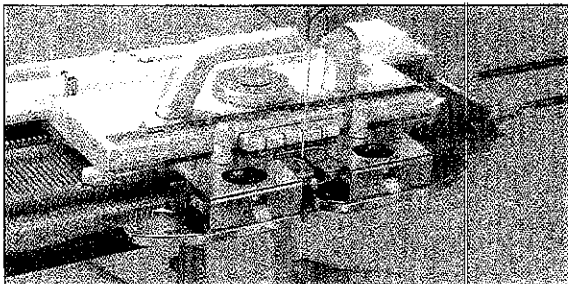

- 2) Insert the unravelled yarn into the YARN FEEDER "A". Close the YARN FEEDER LEVER.

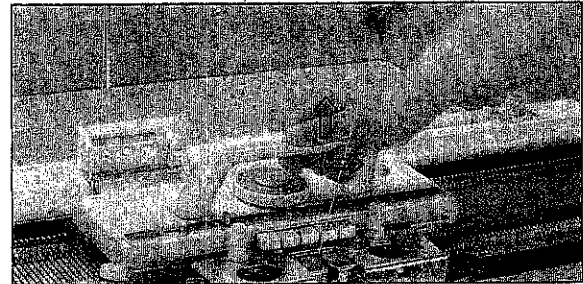

- 3) Operate the K CARRIAGE pulling the yarn up slightly to remove any slack.

LESSON 2

5. BASIC OPERATION PRACTICE II (PATTERN KNITTING)

TUCK STITCH PATTERNS (1M, 2M, 3M, 7M, 8M)

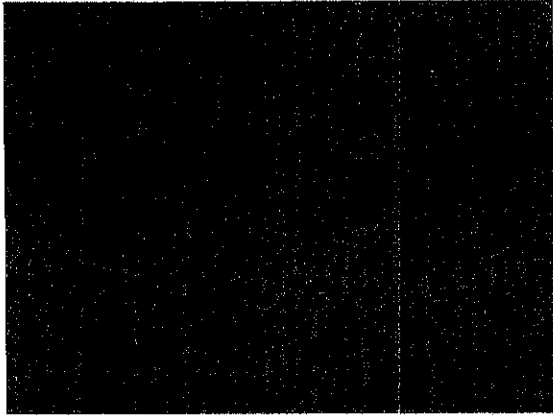

Card No. 1M

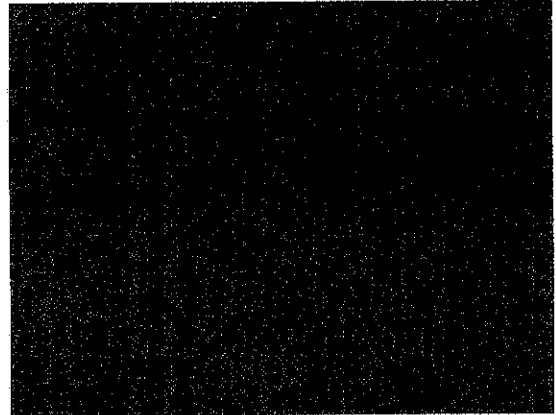

Card No. 2M

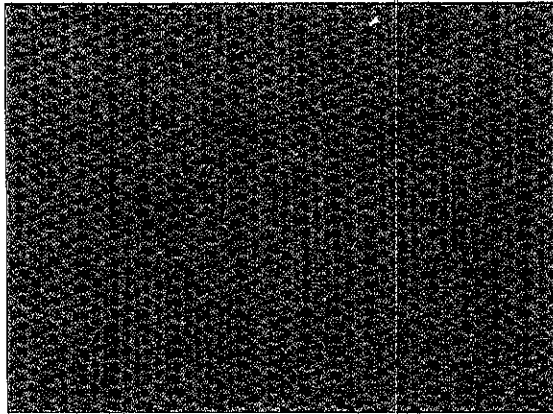

Card No. 3M

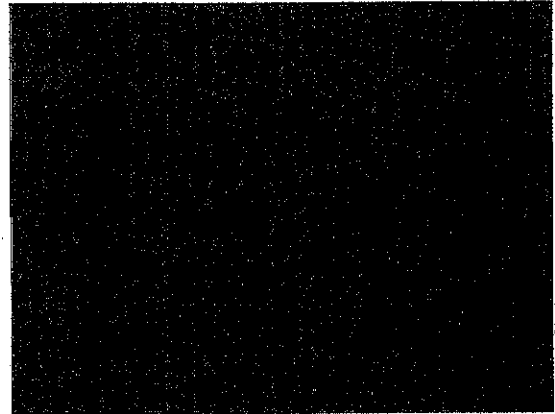

Card No. 4M

TWO COLOR TUCK STITCH PATTERNS (1M, 2M, 3M, 7M)

* Change the yarn in the Yarn feeder "A" every two rows.

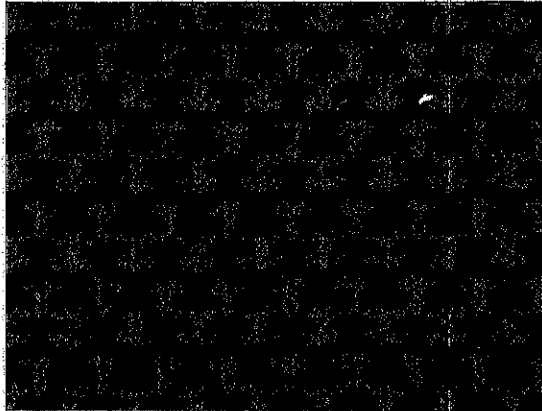

Card No. 2M

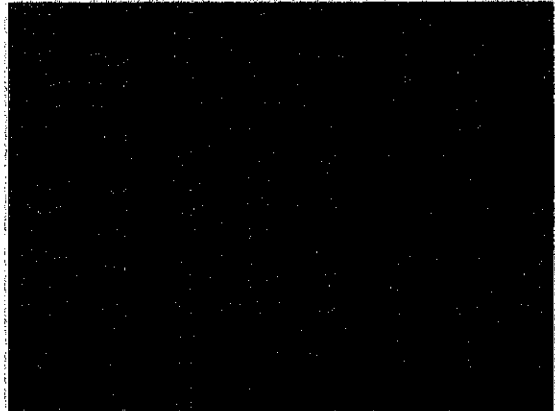

Card No. 3M

SKIP STITCH PATTERNS (1M, 2M, 3M, 5M, 7M, 8M, 11M)

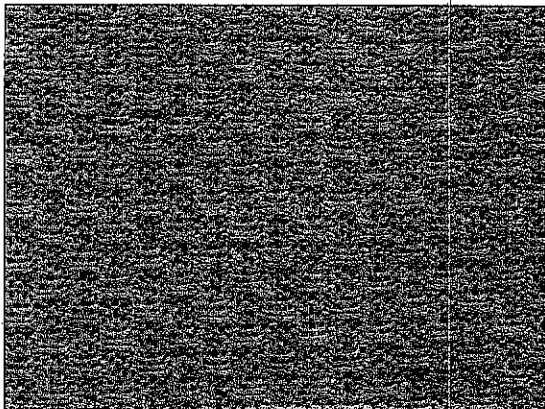

Card No. 2M

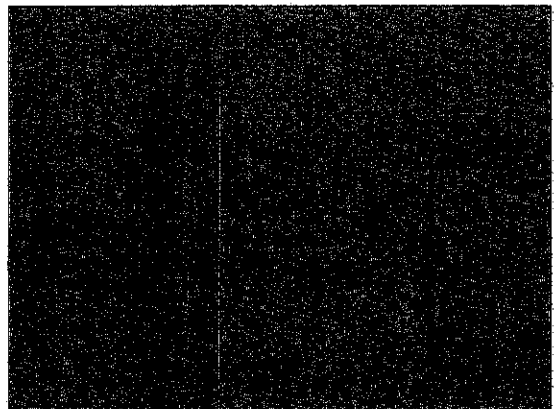

Card No. 3M



Card No. 5M

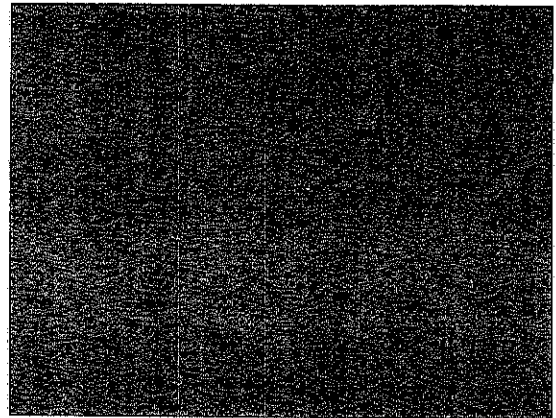

Card No. 11M

TWO COLOR SKIP STITCH PATTERNS (2M, 3M, 5M, 7M, 11M)

* Change the yarn in the Yarn feeder "A" every two rows.

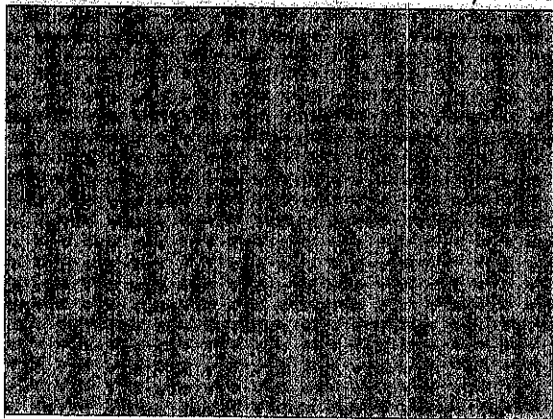

Card No. 5M

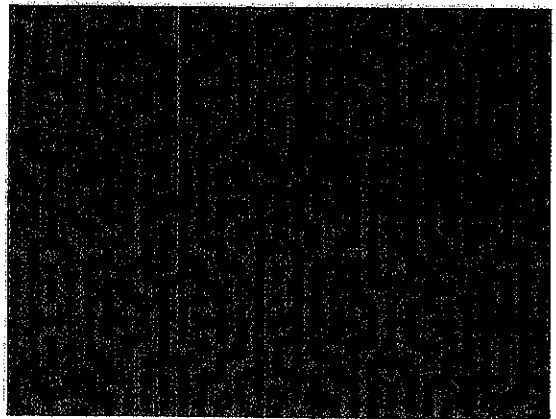

Card No. 7M

FAIR-ISLE PATTERNS (1M, 2M, 3M, 4M, 5M, 6M, 7M, 8M, 9M, 10M, 11M, 12M, 13M, 14M, 15M)

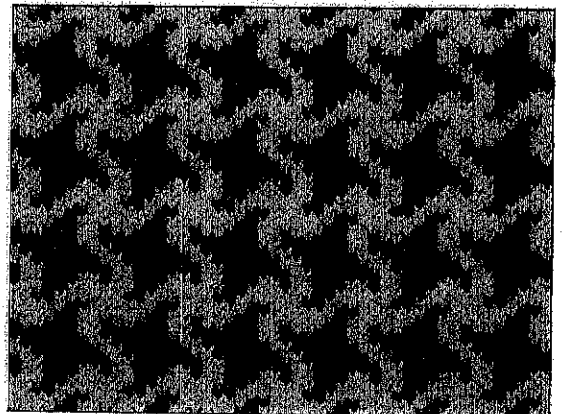
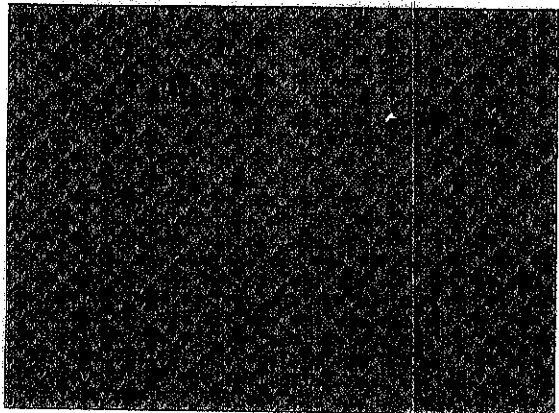

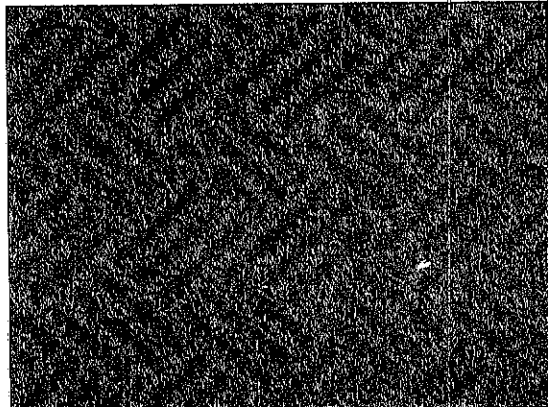

Card No. 14M

FAIR-ISLE MOTIF



Card No. 15M



Card No. 2M

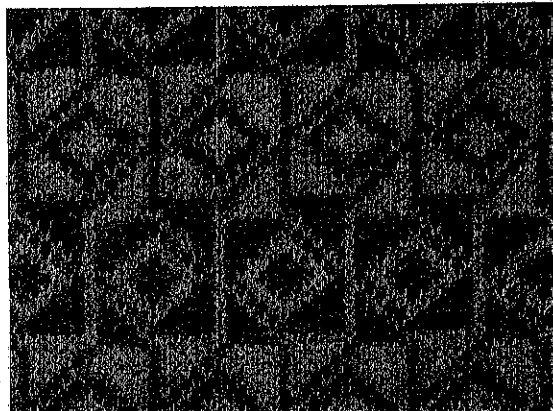

Card No. 14M

WEAVING PATTERNS

(1M, 2M, 3M, 5M, 7M, 8M, 11M, 12M)

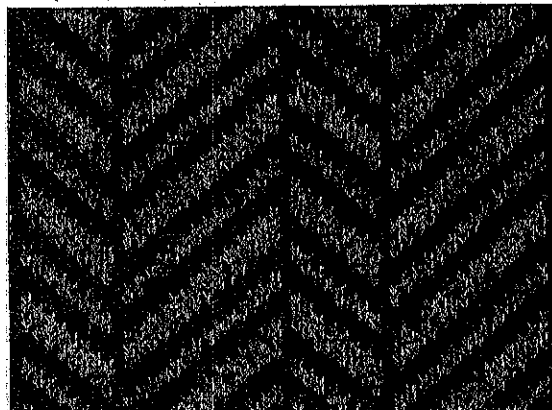

Card No. 1M

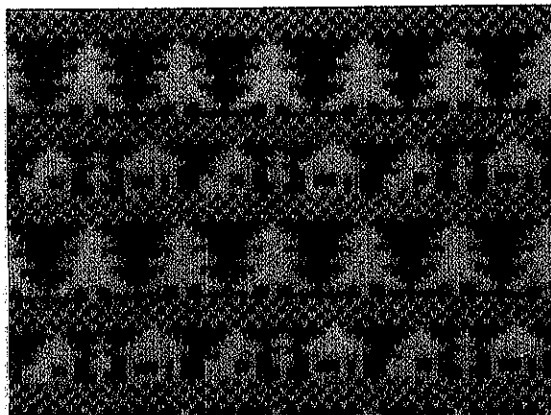

Scheda N° 5M

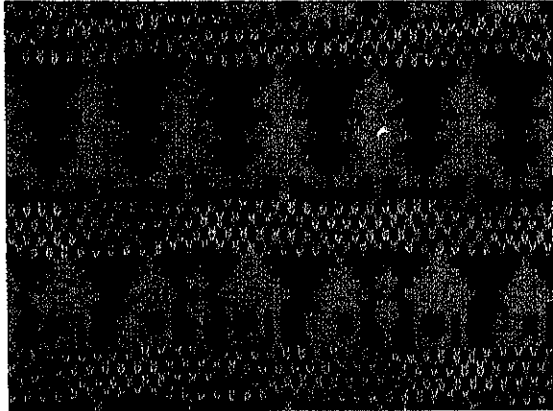

Card No. 5M

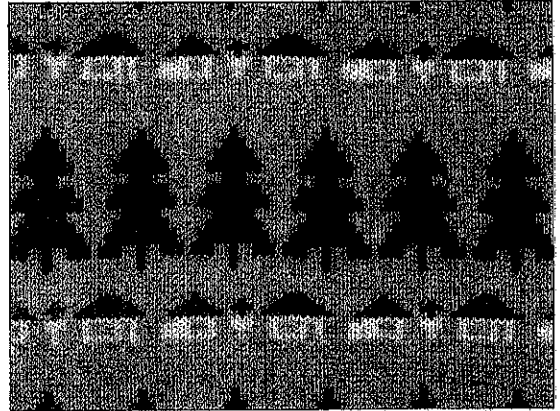

Card No. 6M

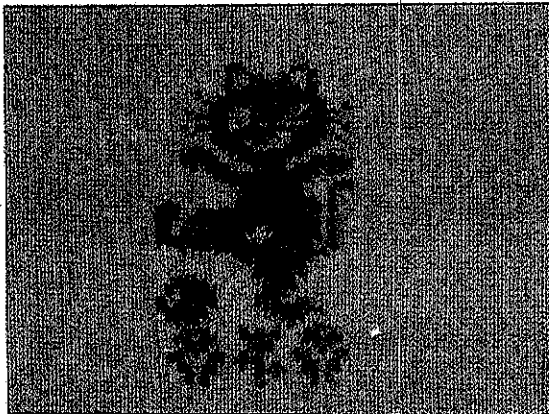

Card No. 10M



Card No. 12M



Card No. 13M

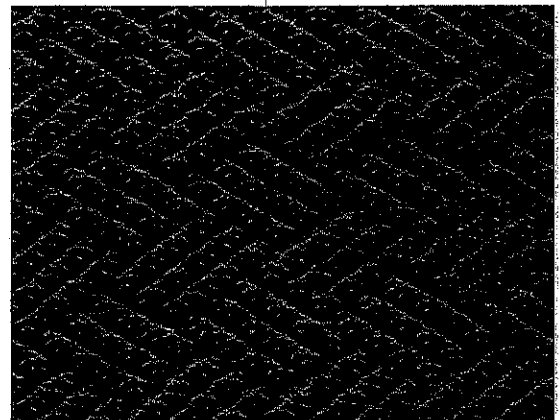

Card No. 14M

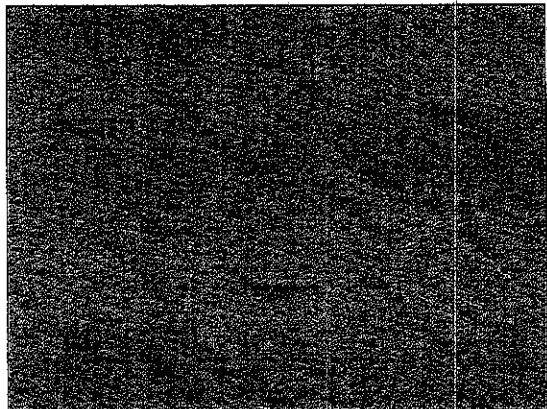

Card No. 7M



Card No. 12M

LACE PATTERNS (16M, 17M, 18M, 19M, 20M)

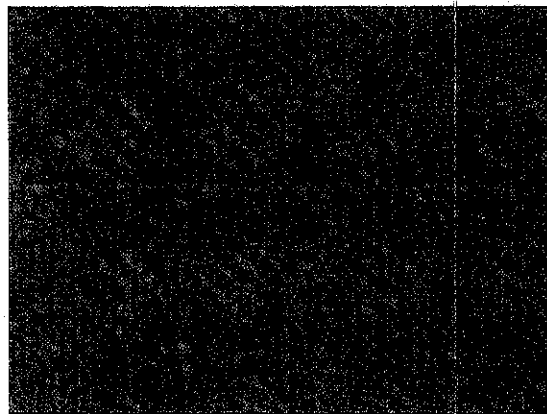

Card No. 16M



Card No. 17M

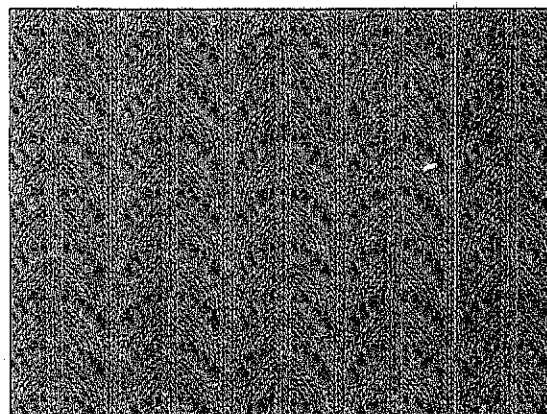

Card No. 18M

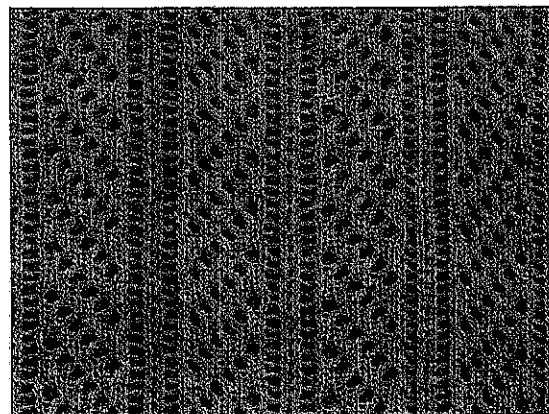

Card No. 20M

FINE-LACE PATTERNS (16M, 17M, 18M, 19M, 20M)

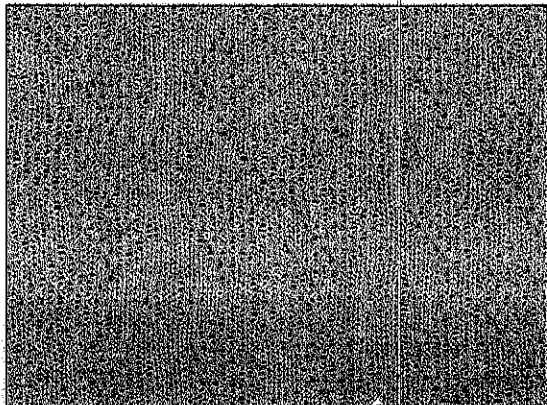

Card No. 16M

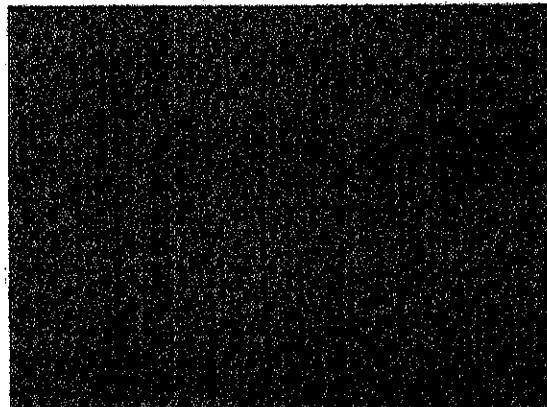

Card No. 17M

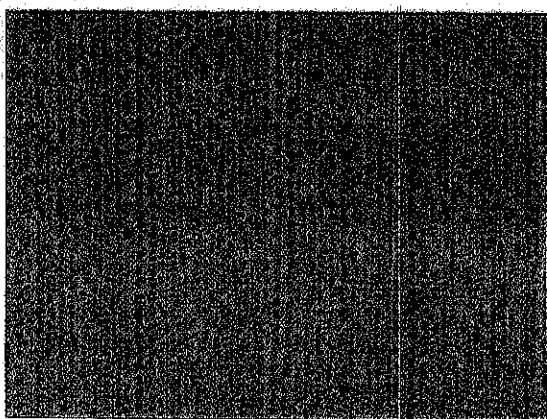

Card No. 20M

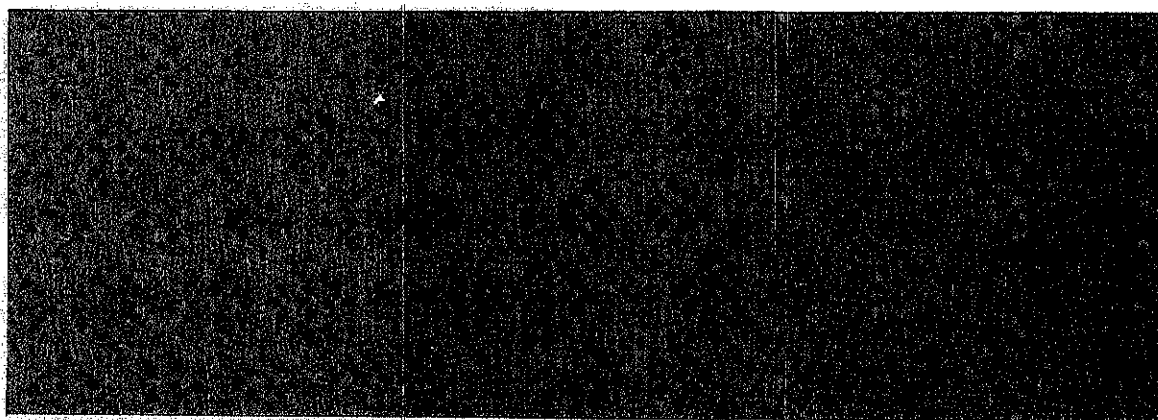

Card No. 19M

(→ = N → = F)

(→ = N → = F)

5-1. PUNCH CARDS

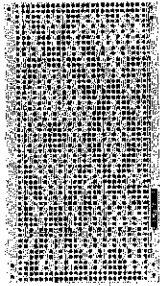

CARD No. 7J

- ★ There are 20 different PUNCH CARDS included as accessories.
 - ★ By using one punch card, it is possible to knit various fancy stitch patterns.
- (★ Refer to the chart on page 41).

★★★ The followings are the example by using the Card No. 7J. ★★★

TUCK STITCH PATTERN

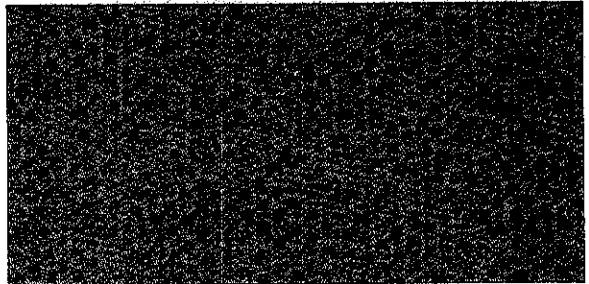
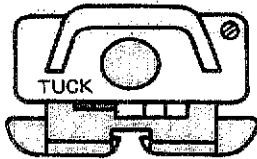

SKIP STITCH PATTERN

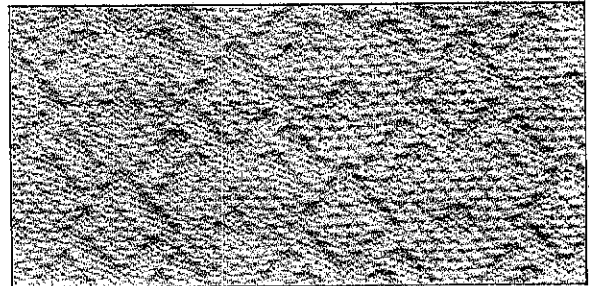
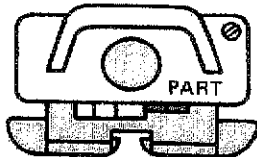

FAIR-ISLE PATTERN

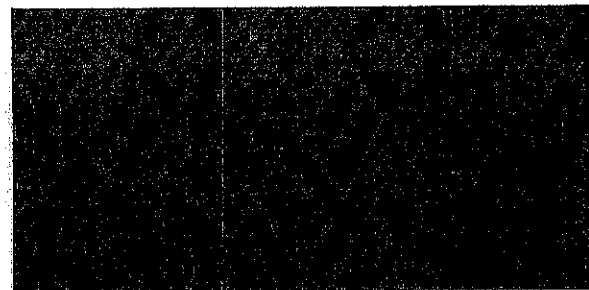
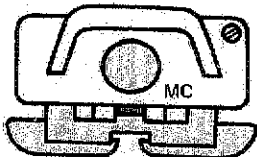

WEAVING PATTERN

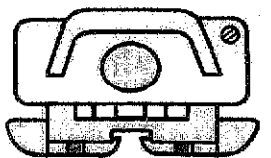

WEAVING

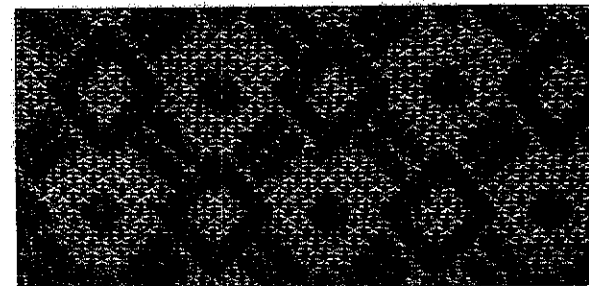

LIST OF PATTERN VARIATION

Each punch card can be used for the pattern(s) marked in the following column.
 Punch cards No. 16J through 20J are special cards for Lace pattern and Fine-lace pattern.

Pattern	Recommended Punch Card No.																			
	1M	2M	3M	4M	5M	6M	7M	8M	9M	10M	11M	12M	13M	14M	15M	16M	17M	18M	19M	20M
Tuck stitch pattern	●	●	●				●	●												
Two color Tuck stitch pattern	●	●	●				●													
Skip stitch pattern	●	●	●		●		●	●			●									
Two color Skip stitch pattern		●	●		●		●				●									
Fair-isle pattern	●	●	●	●	●	●	●	●	●	●	●	●	●	●	●					
Weaving pattern	●	●	●		●		●	●			●	●								
Plating Tuck stitch pattern	●		●					●												
Lace pattern																	○	○	○	○
Fine-lace pattern																●	●		●	●

5-2. RELATION BETWEEN THE PUNCH CARD AND THE NEEDLES

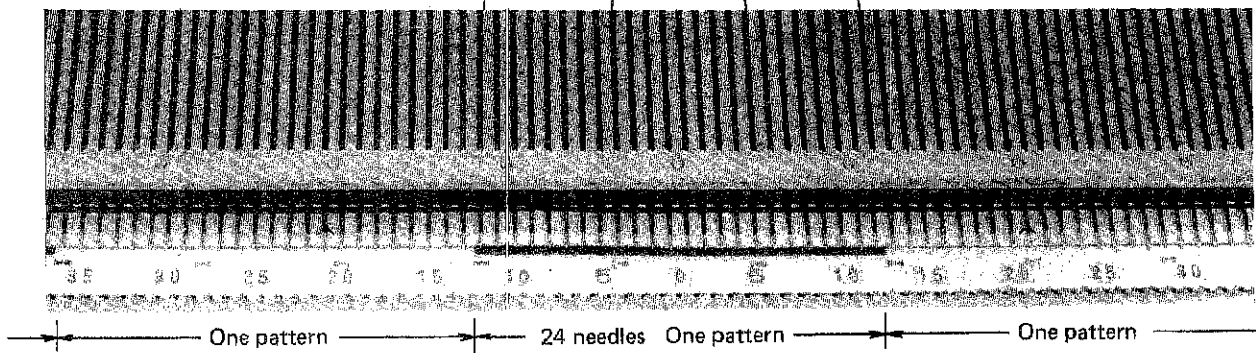
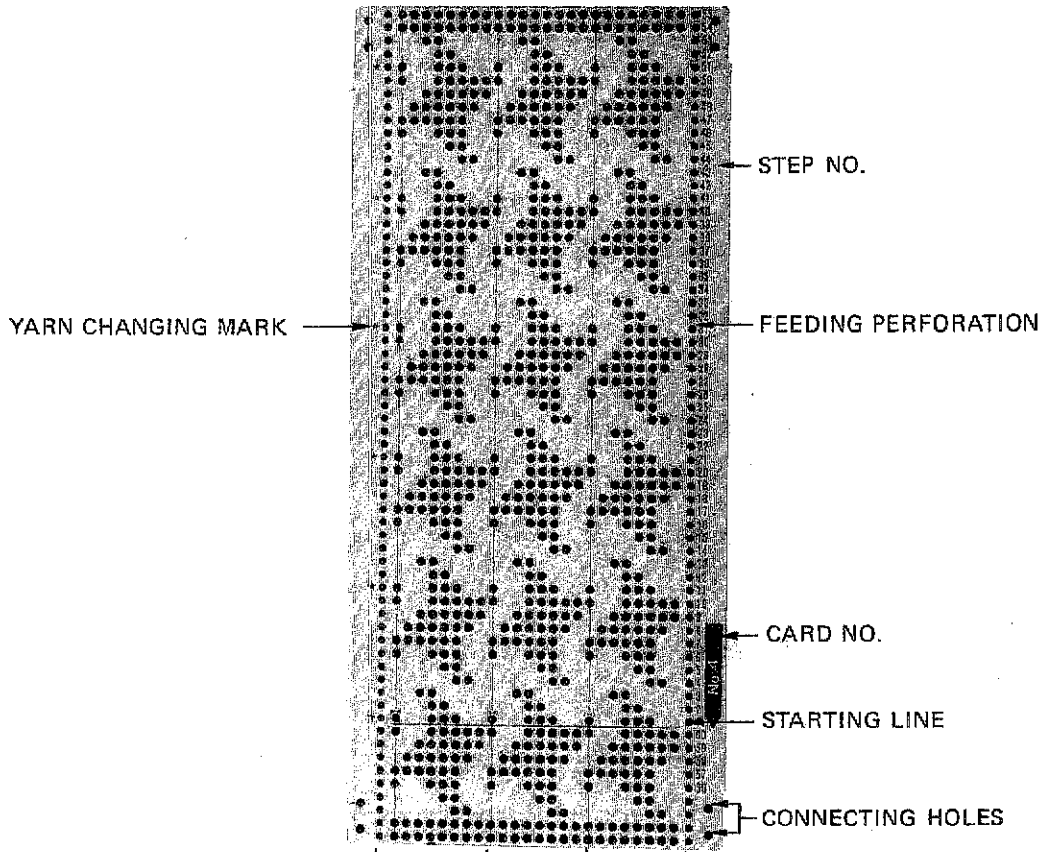

Each perforated line of the punch card controls one needle group, namely 24 needles.
 (12 needles on either side of the center mark "0" make one pattern.)
 Each needle group (24 needles) marked with Red lines on the NEEDLE POSITION INDICATOR makes one pattern.

- ★ The needles corresponding to the holes made on the card are selected to position D by moving the K or L CARRIAGE across the needles in working position.
- ★ When the CHANGE KNOB is set at position "KC" on K CARRIAGE, both end needles in position B are selected to position D per each row regardless of the punch card. This is called the "END NEEDLE SELECTION MECHANISM" and works to avoid the stitch dropping.

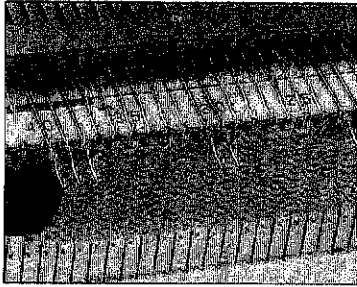

PERFORATIONS

Card No. 4J

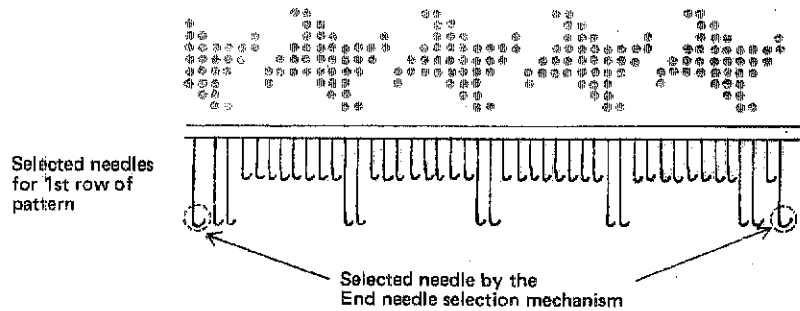

HOW TO CANCEL THE WORKING OF END NEEDLE SELECTION MECHANISM

When knitting the Open stitch pattern with punch card (some needles remain at Position A), cancel the working of End needle selection mechanism on both sides of the K CARRIAGE.

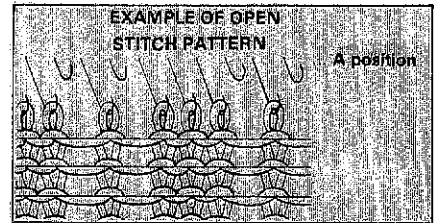

- 1 Set the CHANGE KNOB at position "KC".
- 2 Remove the K CARRIAGE from Needle bed and turn the K CARRIAGE over.
- 3 Set both END NEEDLE SELECTION CAMS (Pink color) to non-working position.
 1. By using the 1 x 3 transfer tool insert the tip of transfer tool into the slot of cam. (See below illustrations).
 2. Turn the transfer tool to the direction of arrow. (After knitting the Open stitch pattern, return them to the working position without fail.)

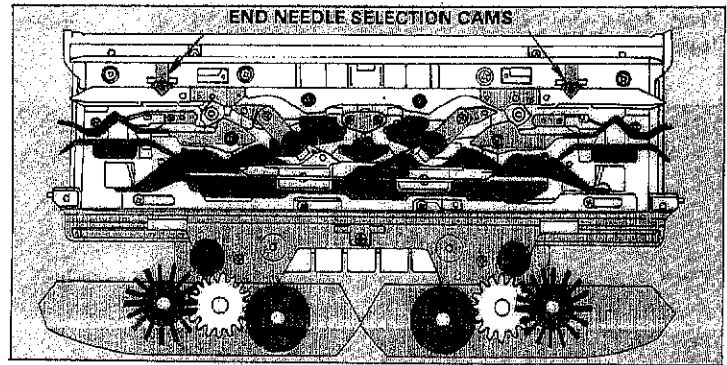

• How to set CAMS to NON-WORKING position.

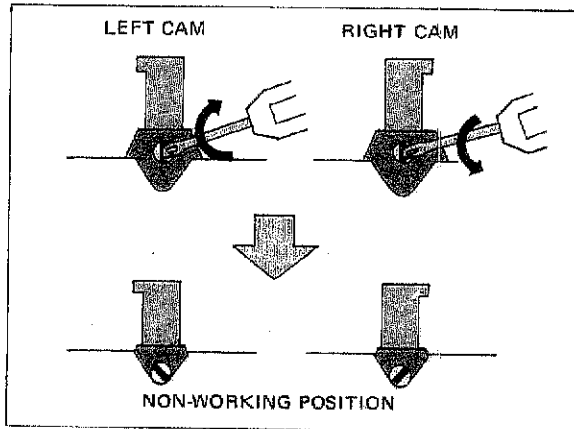

• How to return CAMS to WORKING position.

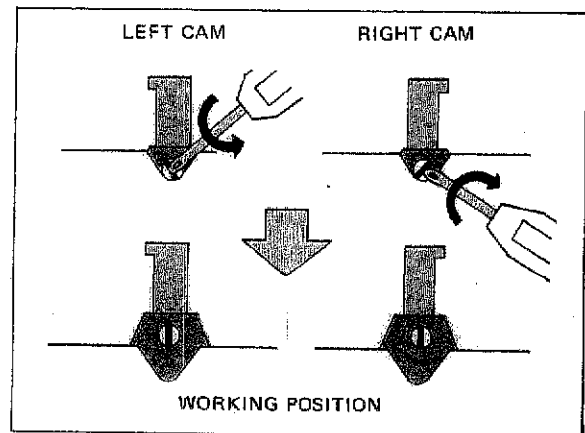

5-3. PREPARATION FOR PATTERN KNITTING

5-3-1. Setting the Punch card

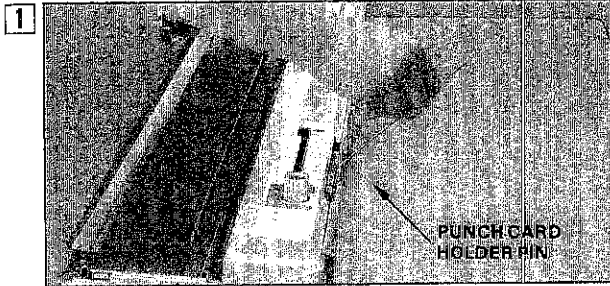

1 Insert the PUNCH CARD HOLDER PIN in the hole behind the slit.

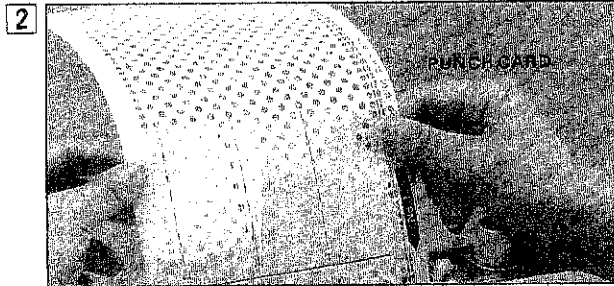

2 Insert the PUNCH CARD into the slit in a straight line with the numbers facing you. Please be careful that when inserting the PUNCH CARD, it is straight.

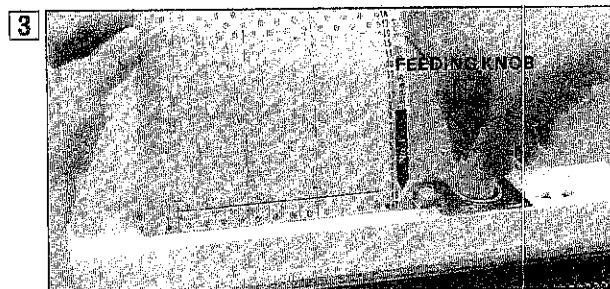

3 Make sure that the starting line is parallel to the panel. Press down the FEEDING KNOB and turn to left to feed the Punch card.

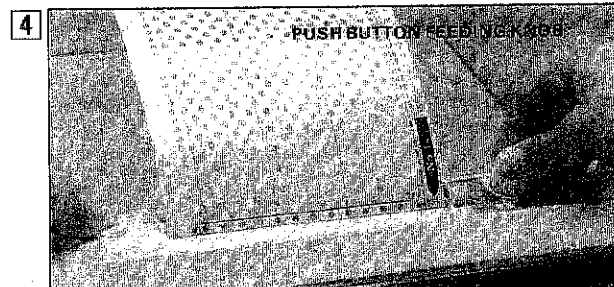

4 It is easier to turn the FEEDING KNOB by pressing down the PUSH BUTTON at the same time.

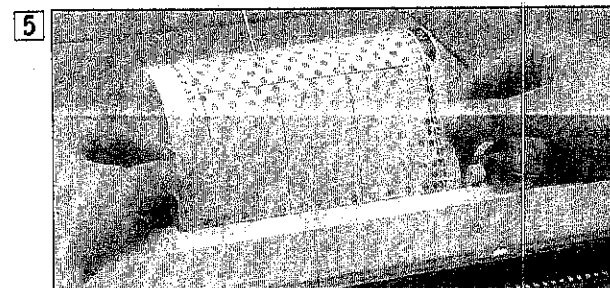

5 The card ends must be overlapped and clipped together with the PLASTIC SNAPS provided in the accessory box to knit the pattern repeatedly.

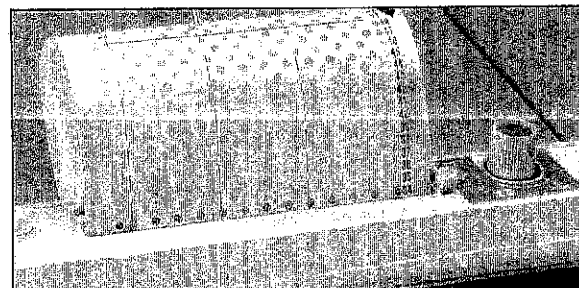

When clipped together, the numbers on the card must continue in the right sequence.

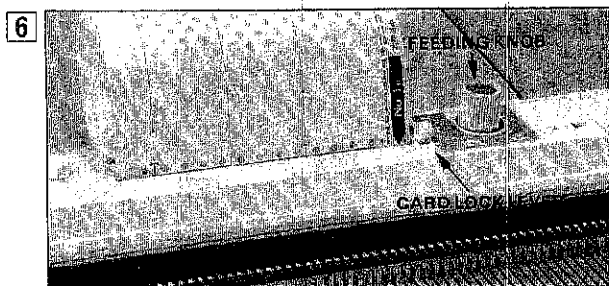

6 Turn the FEEDING KNOB and set to the starting line (No. 1). Set the CARD LOCK LEVER to the "●" mark.

The CARD LOCK LEVER;

- : The punch card is locked even if the carriage is moved.
- ▼: The punch card is rotated by movement of the carriage.
- ∇: Intermittent card feeding position; the punch card is rotated only when the carriage moves from right to left. This position is used for making double length patterns.

5-3-2. Preparation for pattern knitting

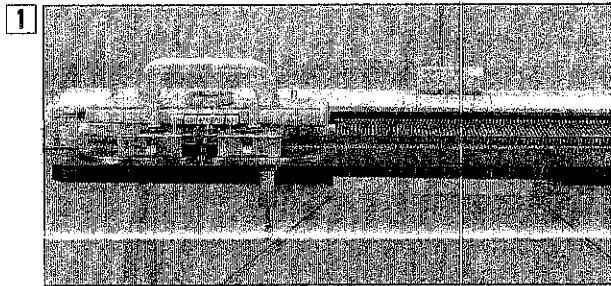

Knit several rows of plain knitting and place the K CARRIAGE on the left side of the machine.

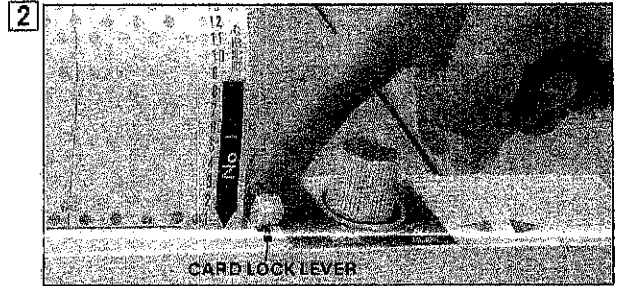

Step ①
Set the CARD LOCK LEVER to the "●" mark.
Make sure that the Punch card is set to the starting line.
(No. 1)

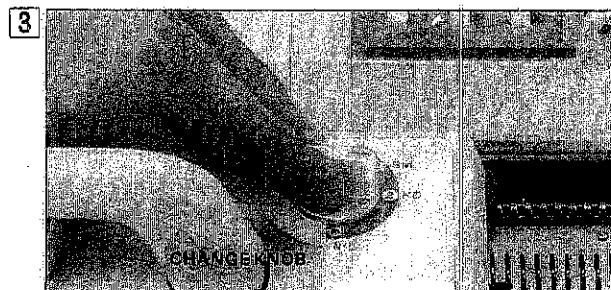

Step ②
Set the CHANGE KNOB to the "KC" position.
For Lace pattern knitting the CHANGE KNOB is to be set to the "N-L" position. (See P. 75)

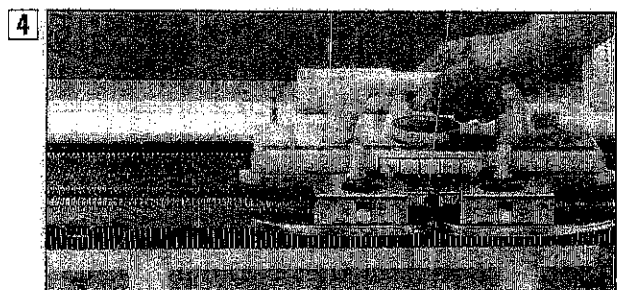

Move the K CARRIAGE from left to right. The needles are selected to position B and D by moving the K CARRIAGE

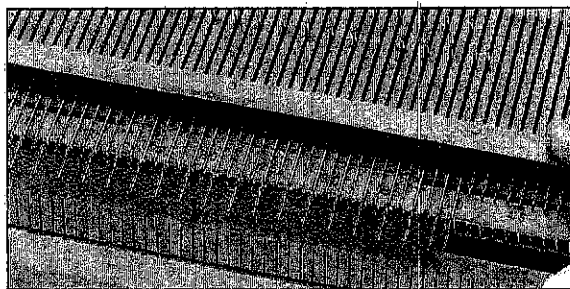

When the CHANGE KNOB is set on the "KC" position, the needles of both ends are brought to position D automatically. (See P. 43)

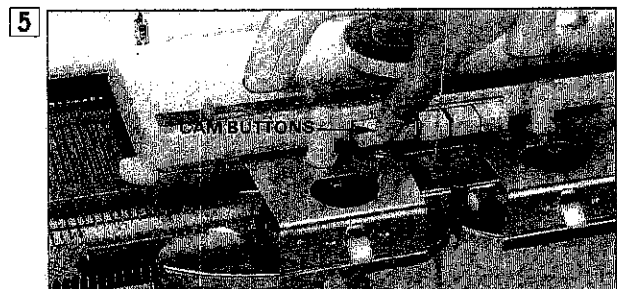

Step ③
Push the CAM BUTTONS according to the pattern you are going to knit.

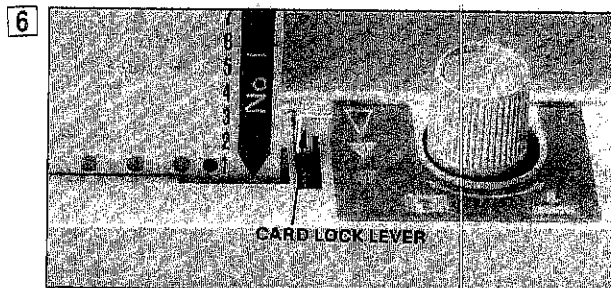

Step ④
Set the CARD LOCK LEVER to the "▼" mark.
Then start pattern knitting.

5-4. TUCK STITCH PATTERNS SKIP STITCH PATTERNS

Tuck Stitch Patterns

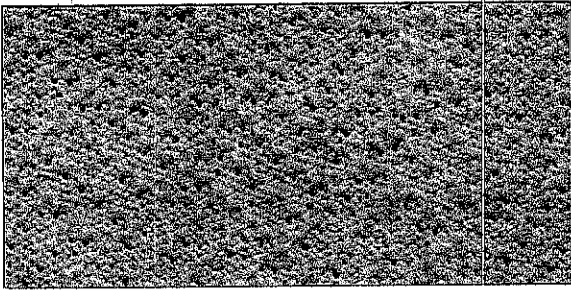

Card No. 5J Tension Dial 6

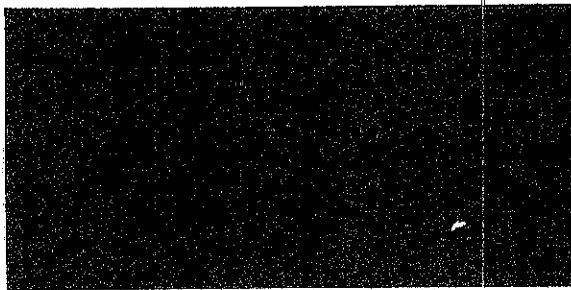

Card No. 11J Tension Dial 6

Skip Stitch Patterns

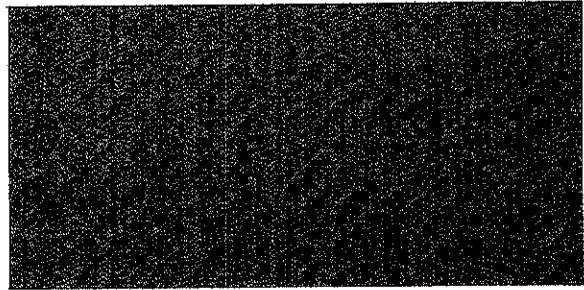

Card No. 5J Tension Dial 6

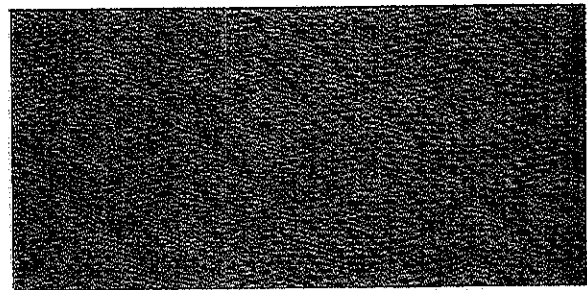

Card No. 11J Tension Dial 6

RUBBER WHEEL

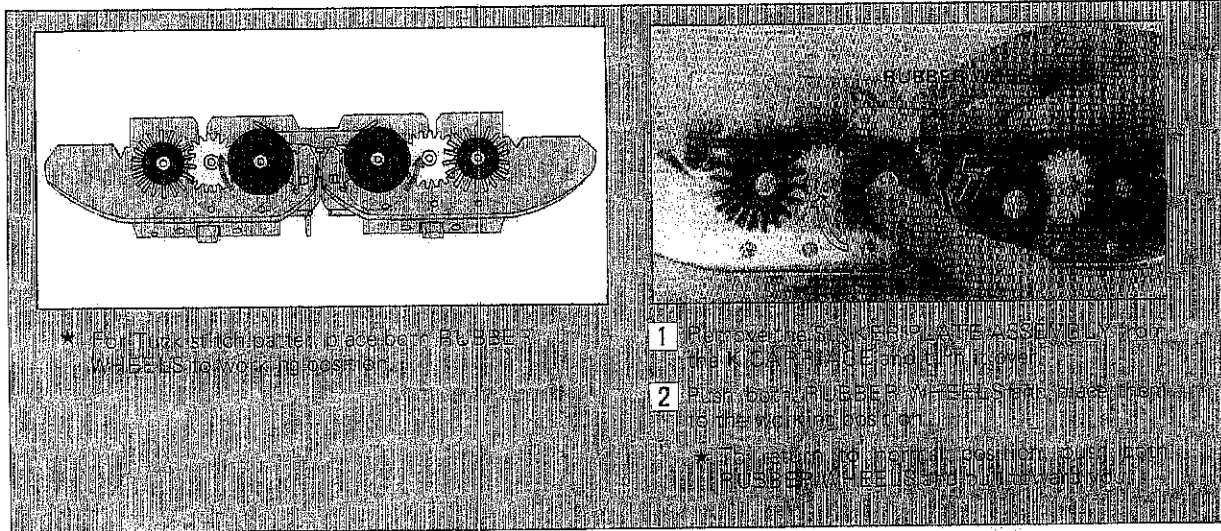

★ Use Punch card No. 11J

★ Prepare medium thickness yarn.

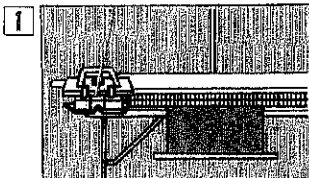

Knit several rows of Plain knitting at T.D. 6, and place K CARRIAGE on the left side of the machine.

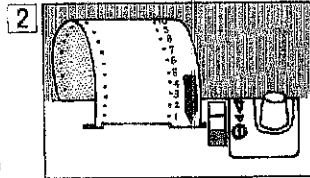

Set the Punch card to the starting line. Set the CARD LOCK LEVER to the "•" mark.

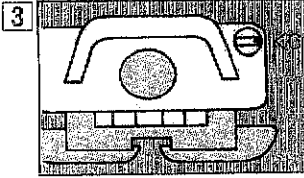

Set the CHANGE KNOB to the "KC" position.

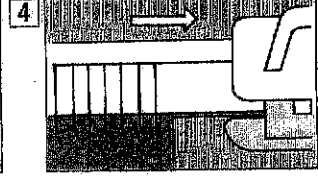

Move the K CARRIAGE from left to right. The needles are selected.

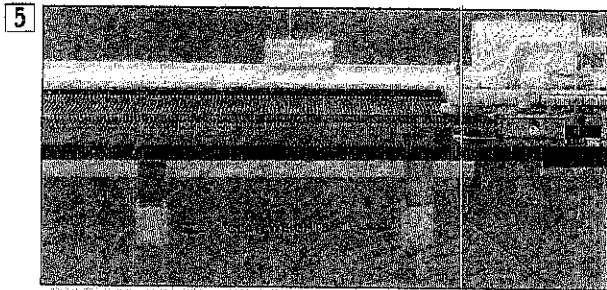

5 Hang the CLAW WEIGHTS onto the CAST-ON COMB (as shown above) to avoid a dropped stitch. The CLAW WEIGHT should be repositioned at the top edges of the knitting at regular intervals.

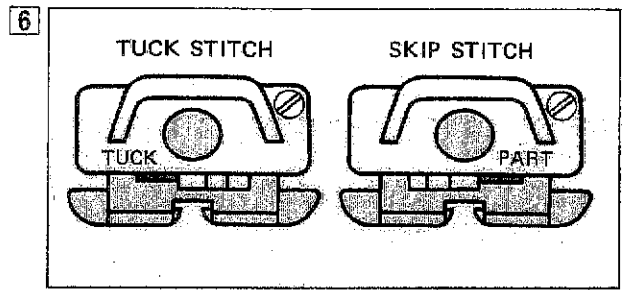

6 Push the CAM BUTTONS according to the pattern you are going to knit.

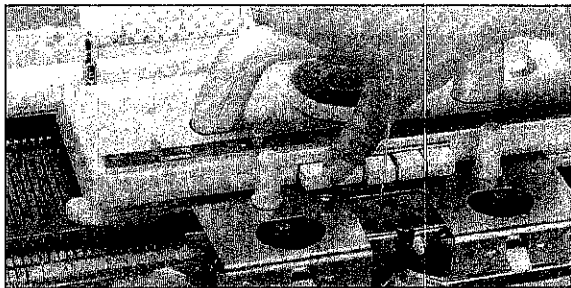

Tuck stitch patterns.....
Push both "TUCK" buttons at the same time.

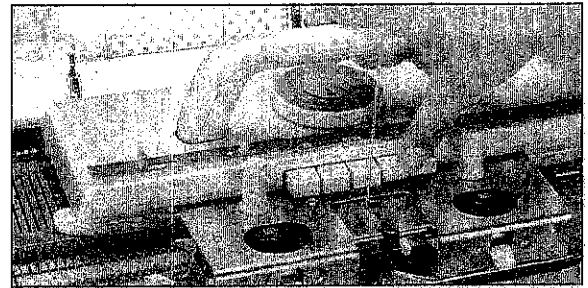

Skip stitch patterns.....
Push both "PART" buttons at the same time.

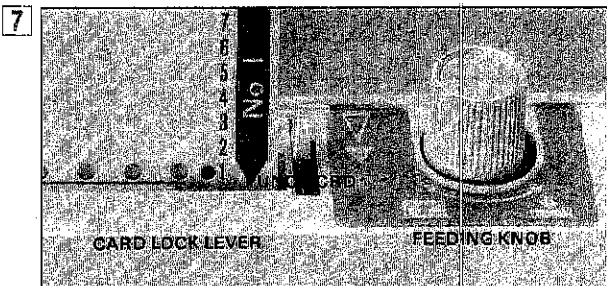

7 Set the CARD LOCK LEVER to "N" mark.

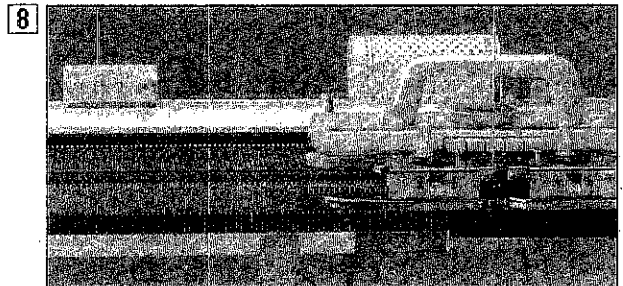

8 Operate the K CARRIAGE from left to right. The needles are selected automatically. Continue knitting.

AFTER FINISHING PATTERN KNITTING

When the starting line (No. 1) of the PUNCH CARD comes to the slit, one pattern is completed. Return to plain knitting as instructed below after finishing any pattern stitches.

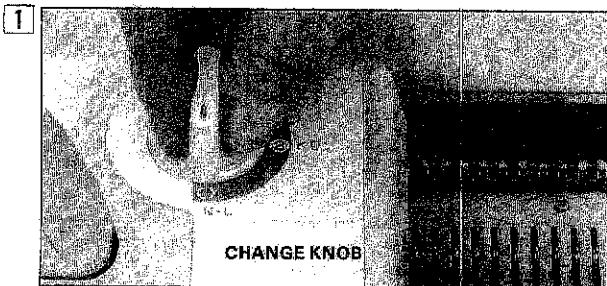

1 By turning the CHANGE KNOB from "KC" or "SM" to "N-L" position the CAM BUTTONS will be restored automatically.

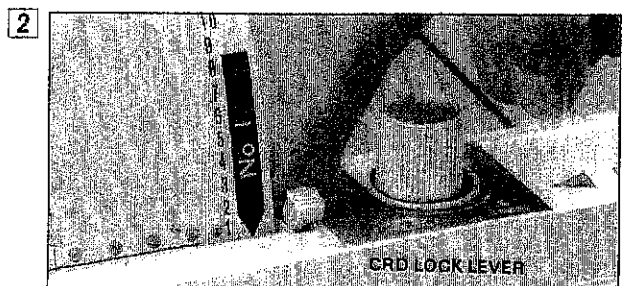

2 Return the CARD LOCK LEVER to the "A" mark. Make sure that the main yarn is in the YARN FEEDER "A". Then do plain knitting.

★ After knitting the Tuck stitch pattern, return both RUBBER WHEELS to normal position.

5-5. TWO COLOR TUCK STITCH PATTERNS TWO COLOR SKIP STITCH PATTERNS

Two Color Tuck Stitch Patterns

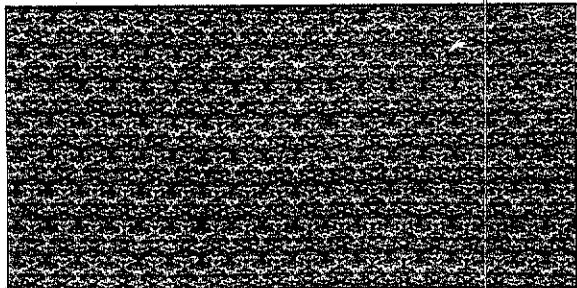

Card No. 2J Tension Dial 6

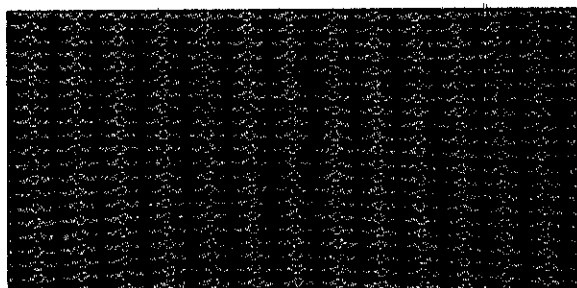

Card No. 3J Tension Dial 6

Two Color Skip Stitch Patterns

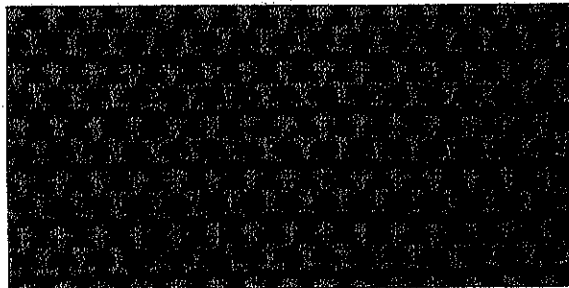

Card No. 2J, Tension Dial 6

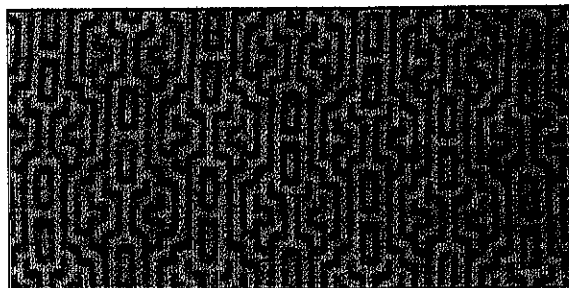

Card No. 7J Tension Dial 6

- ★ Prepare Punch Card No. 2J and two medium yarns in different colors.
- ★ Operation is the same as Tuck stitch patterns and/or Skip stitch patterns.
- ★ Refer to the instructions **1** – **5** on pages 46 and 47 and proceed the steps until **5**.

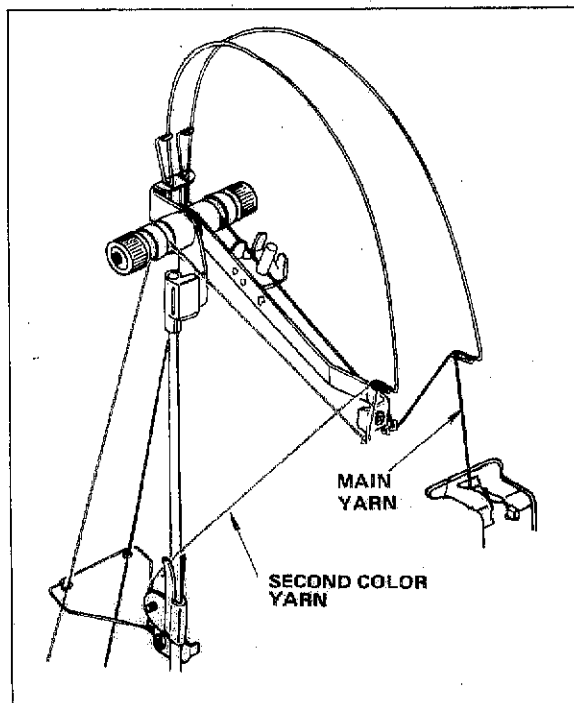

Thread the second color yarn into the YARN TENSION UNIT and clip it under the YARN CLIP.

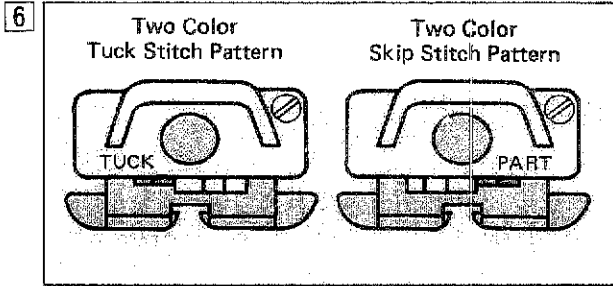

Two color Tuck stitch patterns.....
Push both "TUCK" buttons at the same time.

Two color Skip stitch patterns.....
Push both "PART" buttons at the same time.

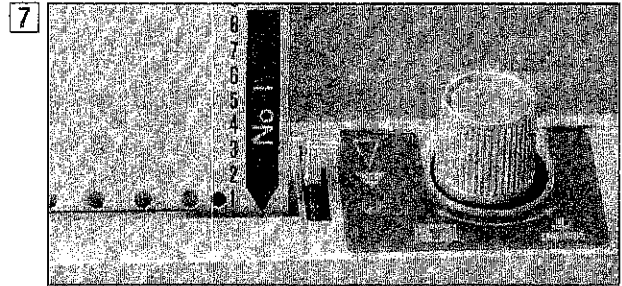

Set the CARD LOCK LEVER to "▼" mark.

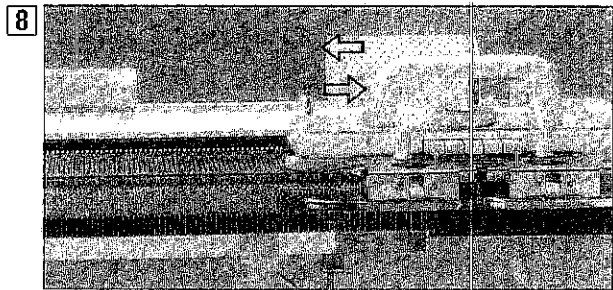

Operate the K CARRIAGE and knit two rows.

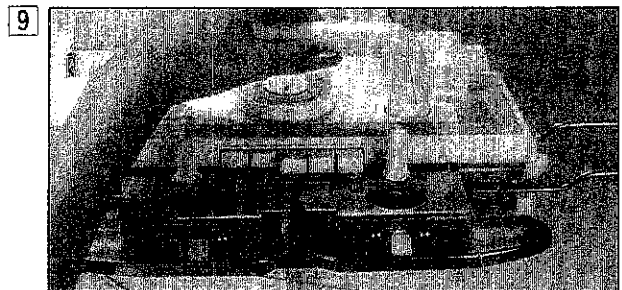

Change the yarn in the YARN FEEDER "A" to the second color yarn for two color patterns. K CARRIAGE is on the right side of the machine. Pull the yarn in the YARN FEEDER "A" out. It is easier to remove the yarn by moving the K CARRIAGE to the right.

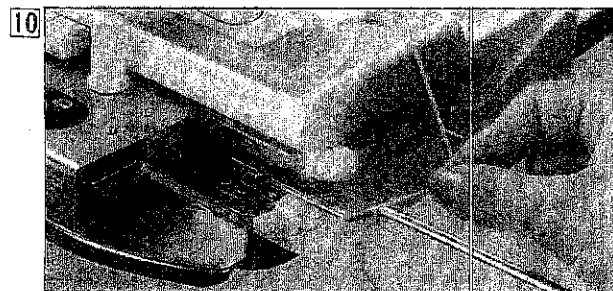

Hook the yarn taken from the YARN FEEDER "A" on the edge of the machine to hold it.

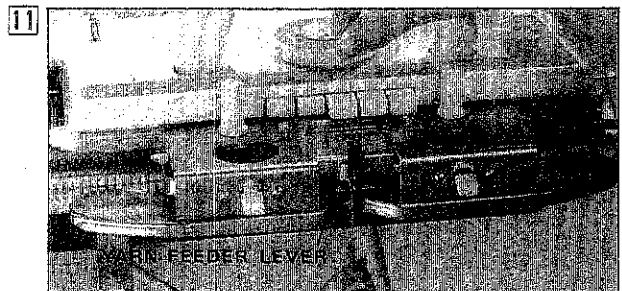

Then, thread the second color yarn which was clipped under the YARN CLIP into the YARN FEEDER "A". Close the YARN FEEDER LEVER.

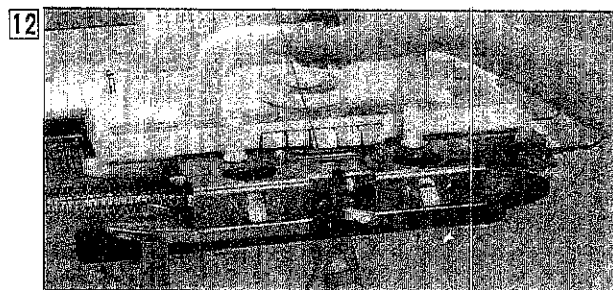

Knit two rows holding the end of the second color yarn under the YARN FEEDER with your left hand. (Keep your left hand at the right edge of the knitting.)

13 Change the yarn in the YARN FEEDER "A" every two rows in the same way as above.

5-6. FAIR-ISLE PATTERNS

Fair-isle patterns

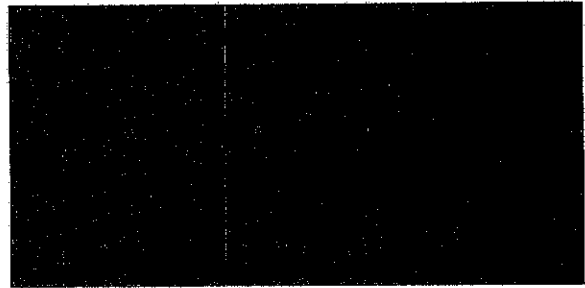
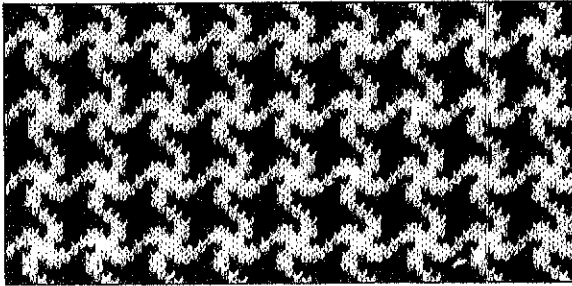

- ★ Prepare Punch card No. 4J and two medium yarns in different colors.

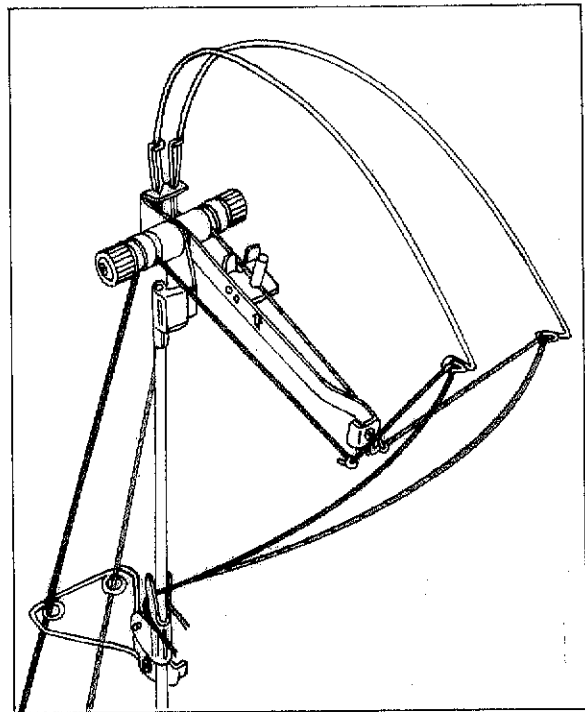

Thread the second color yarn into the YARN TENSION UNIT and clip the yarn under the YARN CLIP.

p50- KC

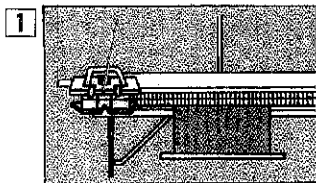

1 Knit several rows of Plain knitting at T.D. 6, and place K CARRIAGE on the left side of the machine.

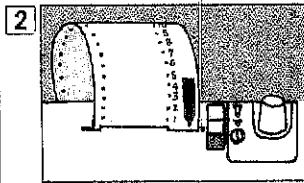

2 Set the Punch card to the starting line. Set the CARD LOCK LEVER to the "e" mark.

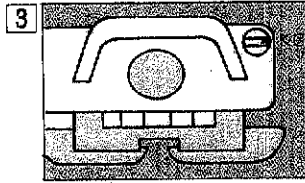

3 Set the CHANGE KNOB to the "KC" position.

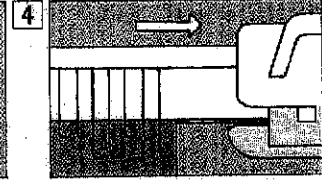

4 Move the K CARRIAGE from left to right. The needles selected.

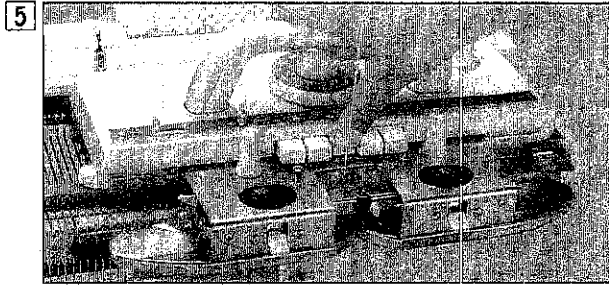

5 Push the "MC" button.

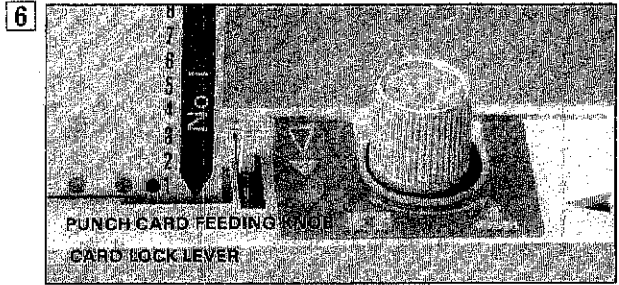

6 Set the CARD LOCK LEVER to the "v" mark.

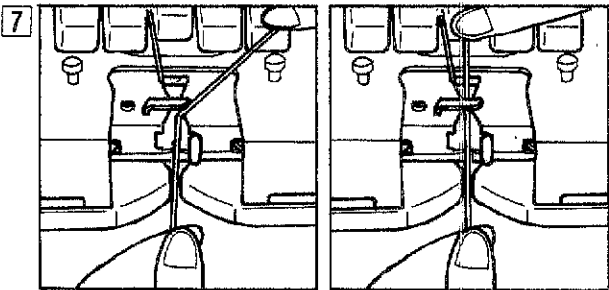

7 Thread the second color yarn which is clipped under the YARN CLIP into YARN FEEDER "B" without opening the YARN FEEDER LEVER. Hold the yarn under the YARN FEEDER with your left hand. (Keep your left hand at the right edge of the knitting.)

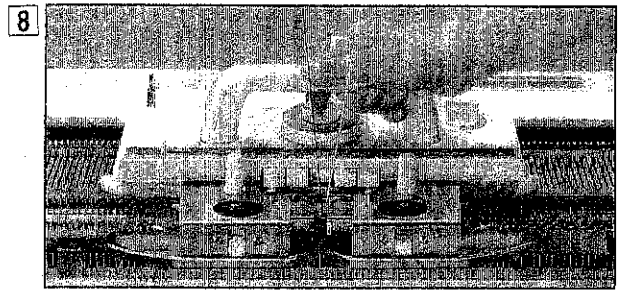

8 Operate the K CARRIAGE from right to left. Continuing to operate the K CARRIAGE.

* When you use Punch cards No. 40, 60, 90, 131 and 154, change the second color yarn in the YARN FEEDER "B" to the third color yarn when the star mark * on the left side of the PUNCH CARD comes to the slit. Then you can knit multi-color Fair Isle patterns. Pull the second color yarn out of the YARN TENSION UNIT and thread the third yarn into it. Then thread the third color yarn into the YARN FEEDER "B".

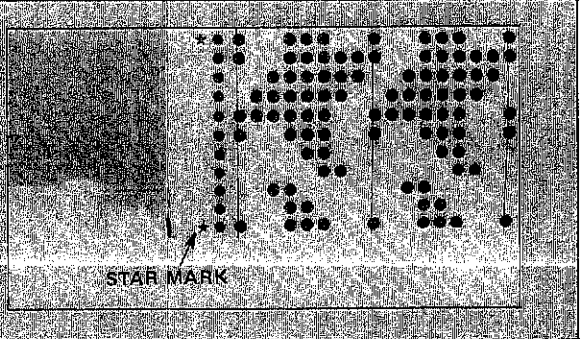

AFTER FINISHING PATTERN KNITTING

When the starting line (No. 1) of the PUNCH CARD comes to the slit, one pattern is completed. Return to plain knitting as instructed below after finishing any pattern stitches.

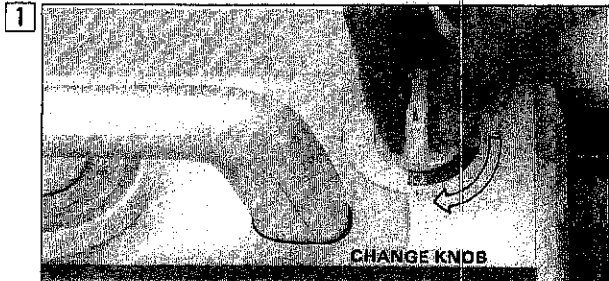

1 By turning the CHANGE KNOB from "KC" or "SM" to "N-L" position, the CAM BUTTONS will be restored automatically.

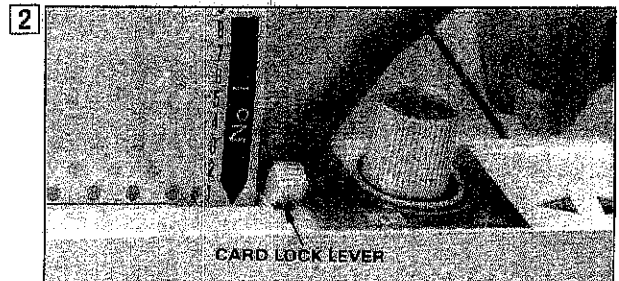

2 Return the CARD LOCK LEVER to the "•" mark. Take the second color yarn out of the YARN FEEDER and clip it under the YARN CLIP. Make sure that the main yarn is in the YARN FEEDER "A". Then do plain knitting.

5-7. FAIR-ISLE MOTIF

(Step No.)

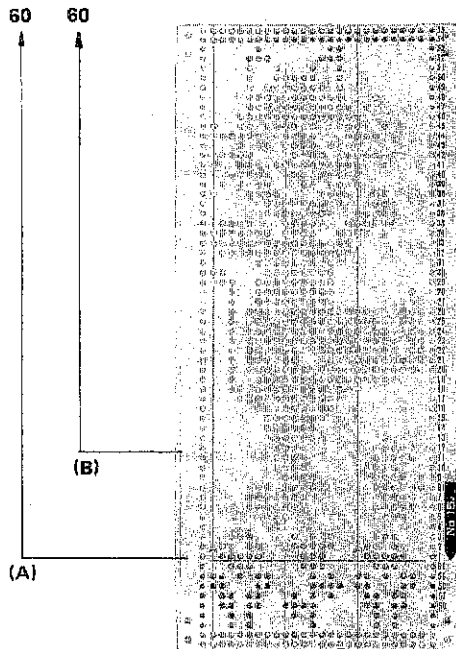

- ★ There are 4 different motif knitting cams which are One-point cam (1 pcs.), Motif knitting cam, center (2 pcs.) Motif knitting cam, left and right (one each).
- ★ The One-point cam is used for knitting the single motif (24 needles width).
- ★ By connecting the Motif knitting cam with others, you can obtain double motif (48 needles width) and triple motif (72 needles width).

Example (A) is a complete pattern of Punch card No. 15J.

Example (B) is knitted until Step No. 45 of the same card as for (A).

Example (C) is knitted from Step No. 17 to 60 of the same card as for (A).

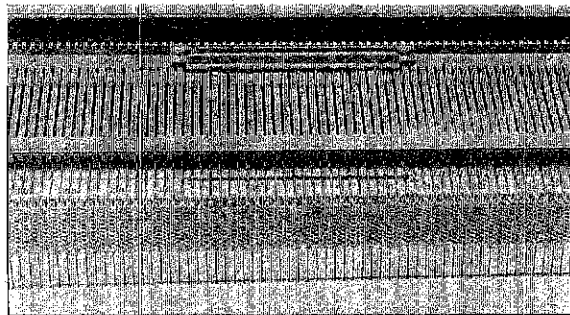

24 needles width

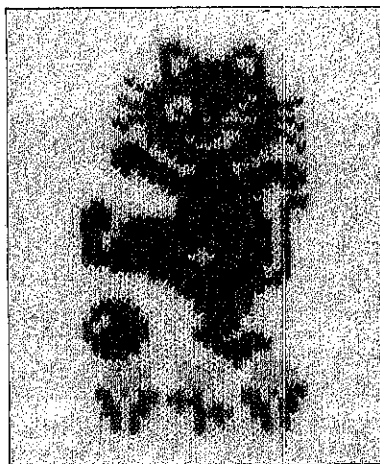

(A)

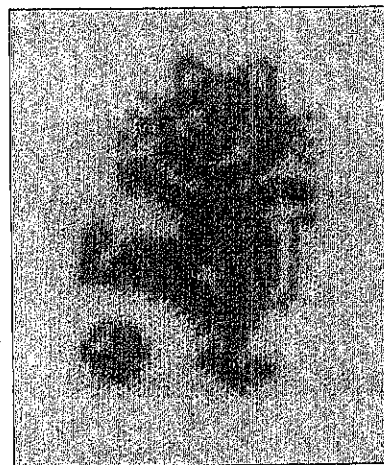

(B)

5-7-1. How to connect the Motif knitting cam

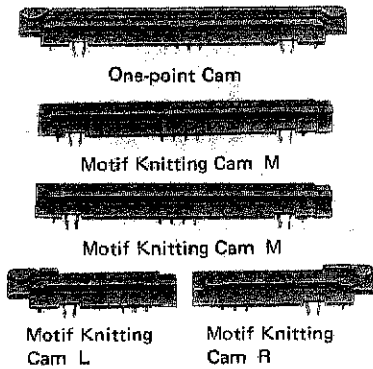

COMBINATION OF CAM

One point cam or Motif knitting cam, left & right connected can be used.

For 24 needles width



For 48 needles width



For 72 needles width



★ How to connect the Motif knitting cam.

- Hold each end of Motif knitting cams and adjust each end (A and B), then push until you hear click.
- To disconnect, pull both cams out.
- Motif knitting cams can not be used individually.

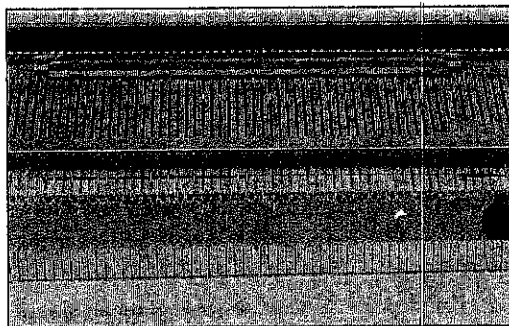
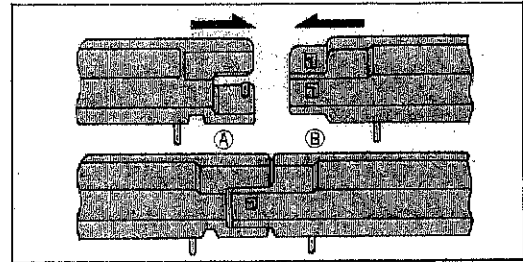

48 needles width

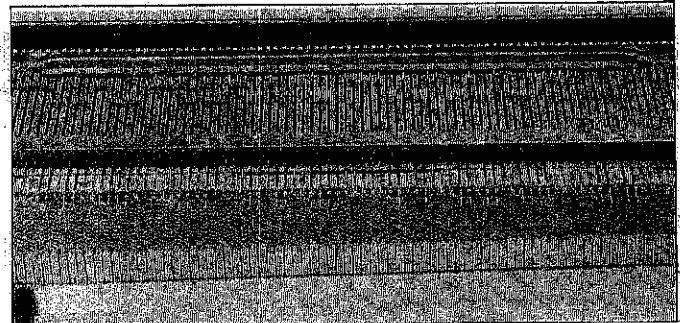

72 needles width

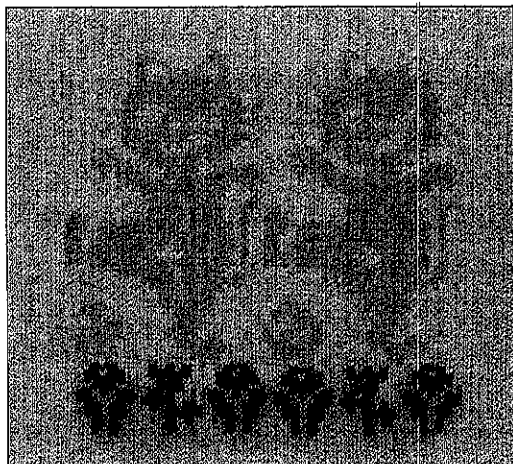

(C)

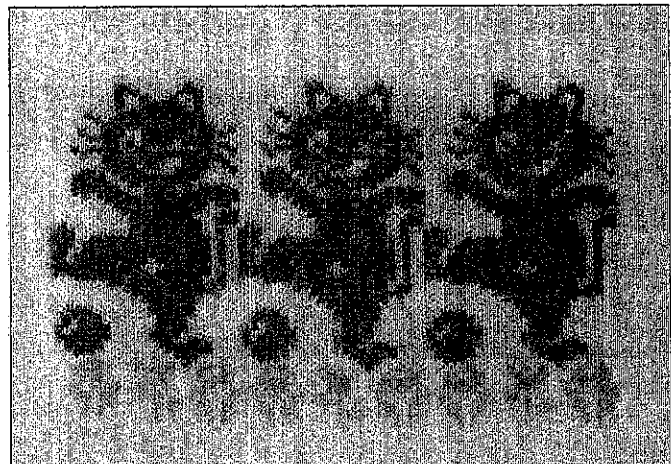

(D)

5-7-2. Preparation for Fair-isle Motif and How to knit.

★ The example is explained by using the One-point cam, however the following instructions are applicable to double and triple motif knitting.

- 1 Thread the second color yarn into YARN TENSION UNIT and clip the yarn under the YARN CLIP.
- 2 Knit several rows of plain knitting and place the K CARRIAGE on the left side of the machine.

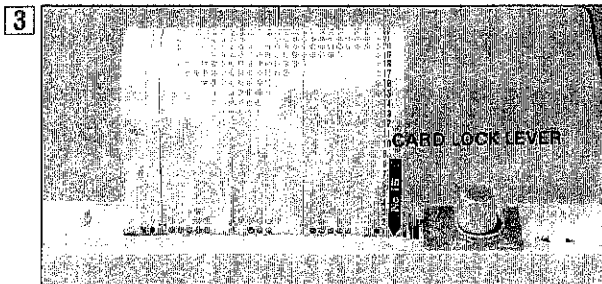

Set the PUNCH CARD to the starting line (No. 1) and the CARD LOCK LEVER to the "●" mark.

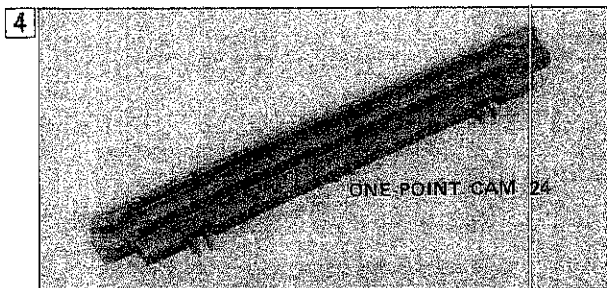

Take the ONE-POINT CAM 24 out of accessory box.

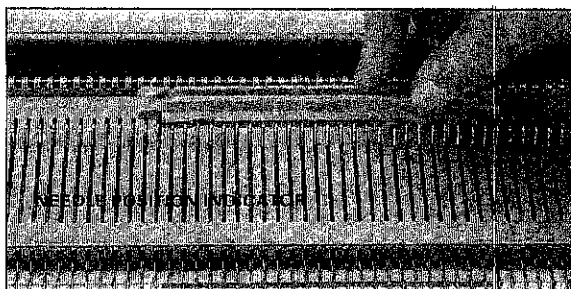
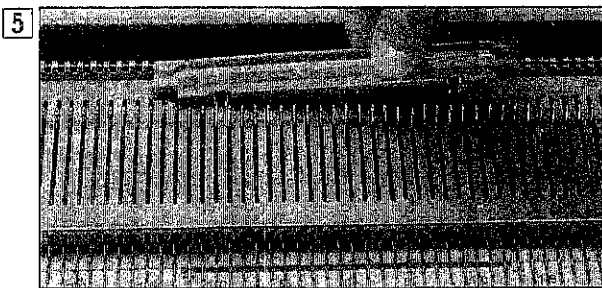

Push the ONE-POINT CAM back as far as it will go and set it in parallel with Rear rail. Make sure that the ONE-POINT CAM is set on the proper position which corresponds to the red line marks of the NEEDLE POSITION INDICATOR.

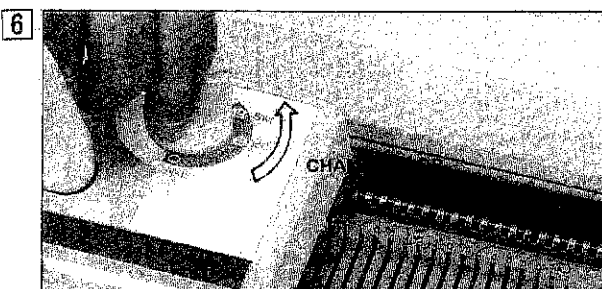

Set the CHANGE KNOB to the "SM" position.

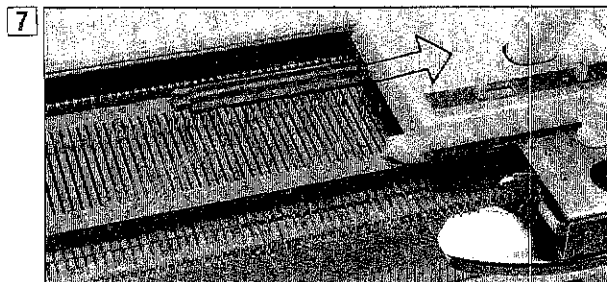

Move the K CARRIAGE from left to right.

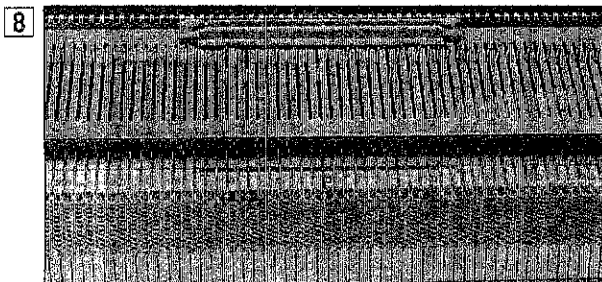

The needles in position B where the ONE-POINT CAM is set are selected to position B and D by moving the K CARRIAGE.

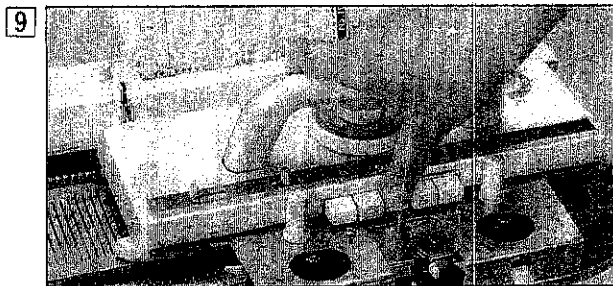

9

Push the "MC" button.

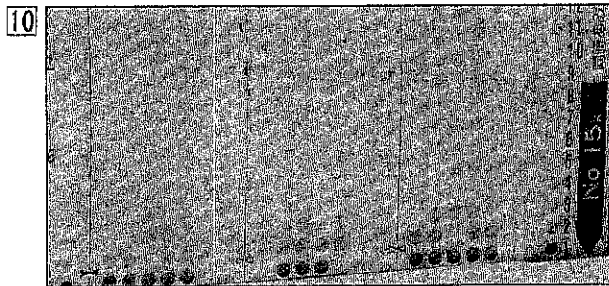

10

Set the CARD LOCK LEVER to the "▼" mark.

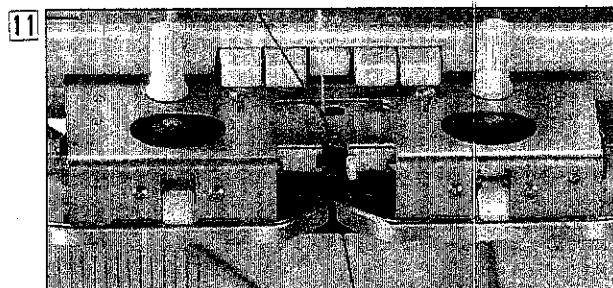

11

Thread the second color yarn which is clipped under the YARN CLIP into YARN FEEDER "B" without opening the YARN FEEDER LEVER. Hold the Yarn under the YARN FEEDER with your left hand.

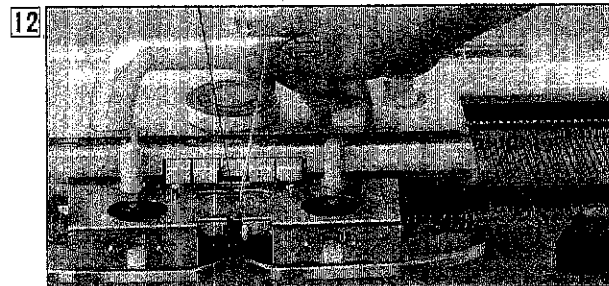

12

Knit one row and place the K CARRIAGE on the left side of the machine.

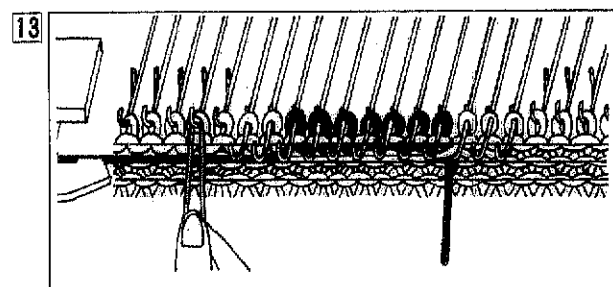

13

Bring forward to position D the second needle from the end of selected needle on the K CARRIAGE side and put a separate single strand yarn into its hook. Then push the needle to position B.

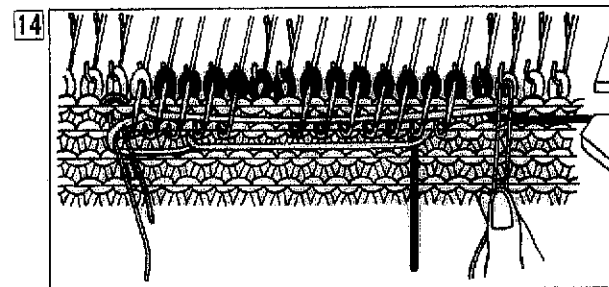

14

Move the K CARRIAGE from left to right and put the separate single strand yarn in the same way as the left side.

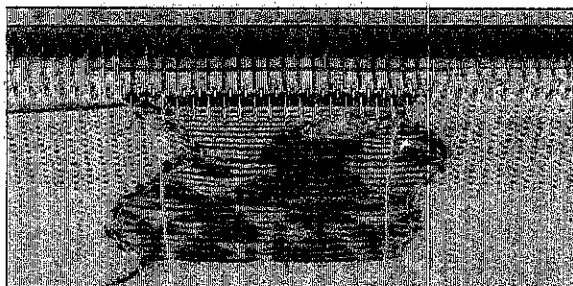

This is to stop the gap which sometimes appears between the edge of the motif and the background color.

* It is better to use the same color as the main yarn for the separate yarn.



15

Move the K CARRIAGE and repeat these steps for each row.

Now, Fair-isle Motif is completed.

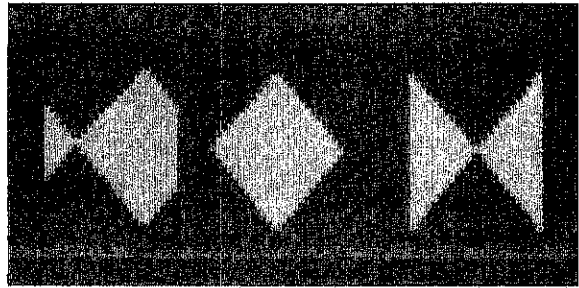
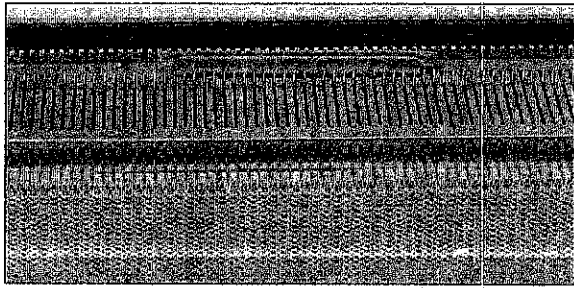

As shown in the figure, by changing the setting position of the ONE-POINT CAM, you can also enjoy unique Fair-isle Motifs.

5-7-3. Double Motif

- 1 Set the ONE-POINT CAM and the Right and Left Motif Knitting Cam on the needle bed as shown in the figures.
Take a space for one pattern (24 needles) between the two CAMS.
- 2 The operation is the same as Fair-isle motif.

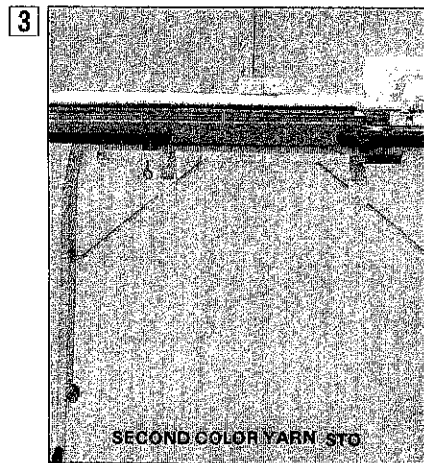
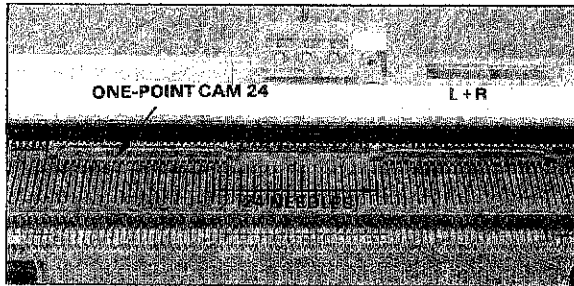

Place the second color yarn for each pattern at your feet.

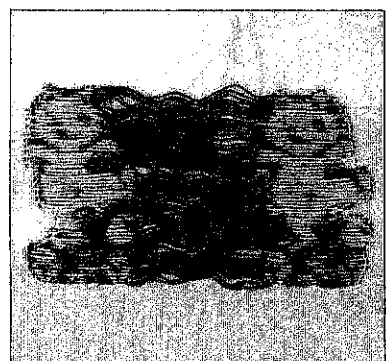
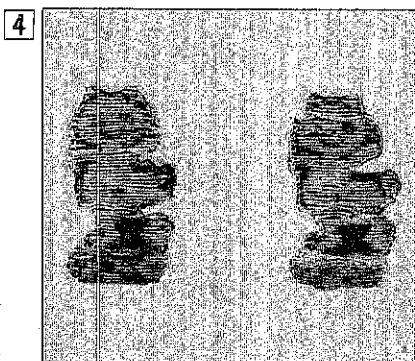

Change the second color yarn whenever the K CARRIAGE moves to avoid traversing yarn at the back of the knitting.

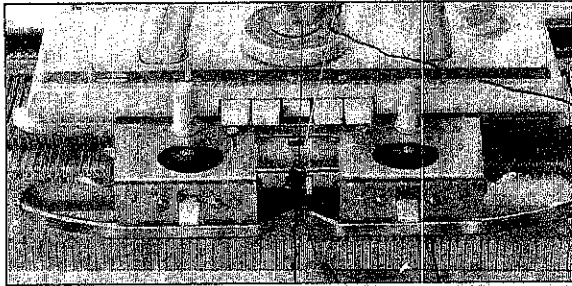

1) When the YARN FEEDER of K CARRIAGE comes to the center of the two patterns, change the yarn in the yarn feeder "B" to the second color yarn for the left motif.

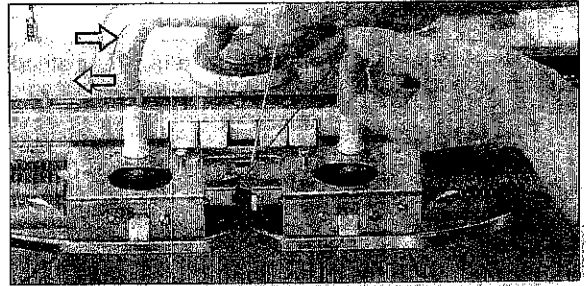

2) Move the K CARRIAGE to left and come back to the center of the two patterns.

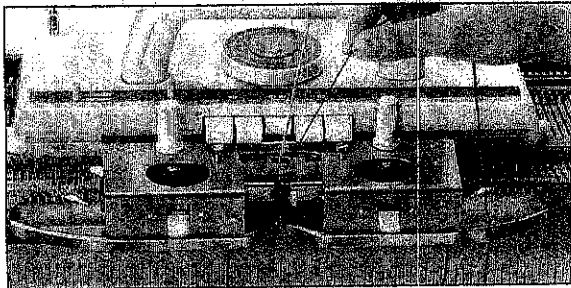

3) Change the yarn in the yarn feeder "B" to the second color yarn for the right motif.

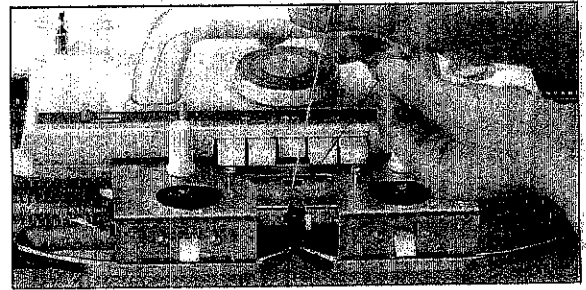

4) Move the K CARRIAGE to right and come back to the center of the two patterns.

5) Repeat these steps each row.
Then, you have made a Double motif.

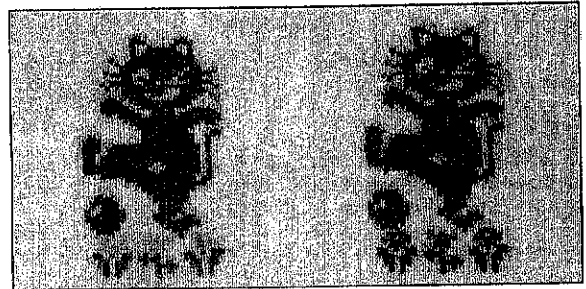

5-8. Double Length Patterns

You can double the length of the pattern. This method is applicable to the Fair-isle patterns, Weaving patterns and Skip stitch patterns. (Do not apply this method to the Tuck stitch patterns and Lace patterns.)

The PUNCH CARD is rotated only when the K CARRIAGE moves from RIGHT to LEFT.

Card No. 13J

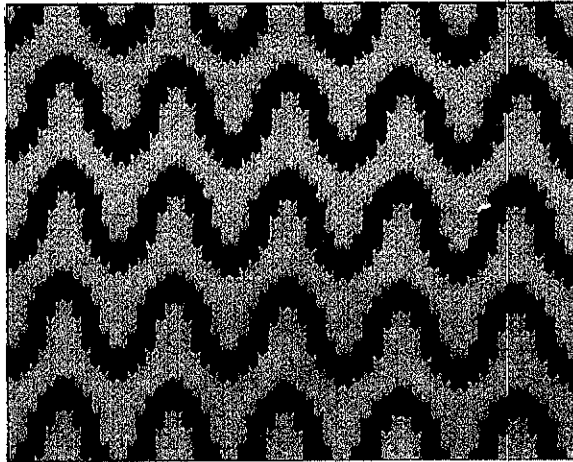

Normal Length Pattern

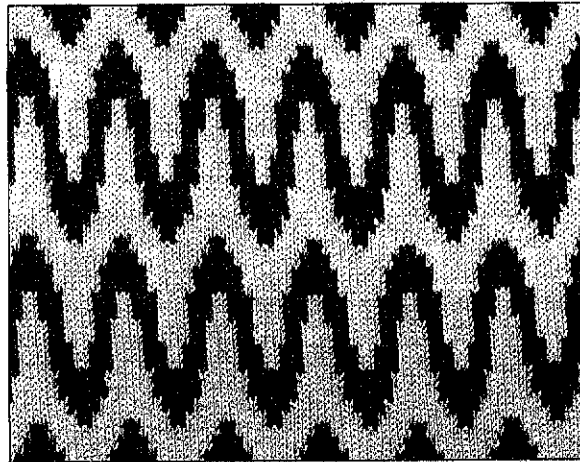

Double Length Pattern

5-8-1. Preparation for Double Length Patterns.

★ Prepare Punch card No. 13J and two medium yarns in different colors.

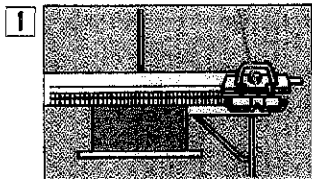

1 Knit several rows of Plain knitting at T.D. 6, and place K CARRIAGE on the right side of the machine.

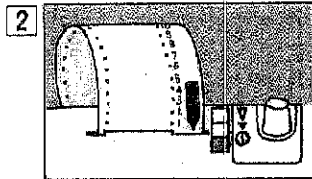

2 Set the Punch card to the starting line.
Set the CARD LOCK LEVER to the "•" mark.

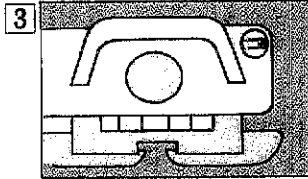

3 Set the CHANGE KNOB to the "KC" position.

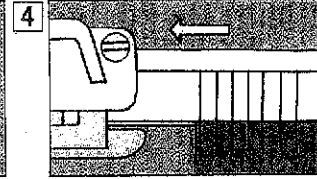

4 Move the K CARRIAGE from right to left. The needles are selected.

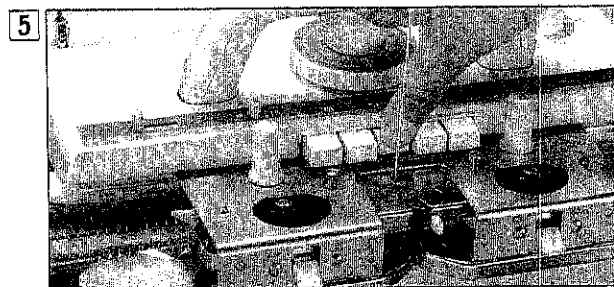

5 Push the MC BUTTON (or set the WEAVING PATTERN LEVERS according to the pattern you are going to knit).

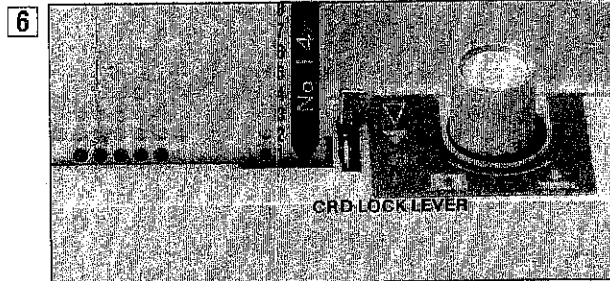

6 Set the CARD LOCK LEVER to the "∇" mark.

7 Operation is the same as in other pattern knitting.

5-8-2. When Knitting Normal and Double Length Patterns Mixed.

In the same way as the Double length patterns, put the K CARRIAGE on the right side of the machine and select the needles.

When the "★" mark on the left side of the punch card comes to the slit, change the setting of the CARD LOCK LEVER ("▽" or "▼") and continue knitting.

When you change the CARD LOCK LEVER, the K CARRIAGE is always on the left side of the machine.

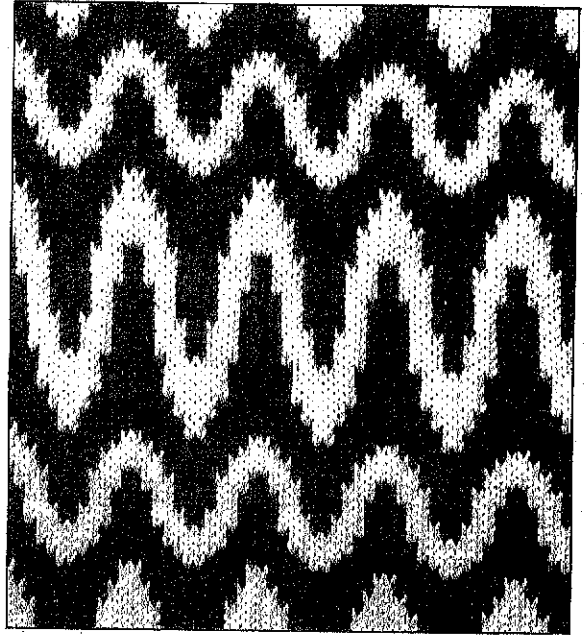
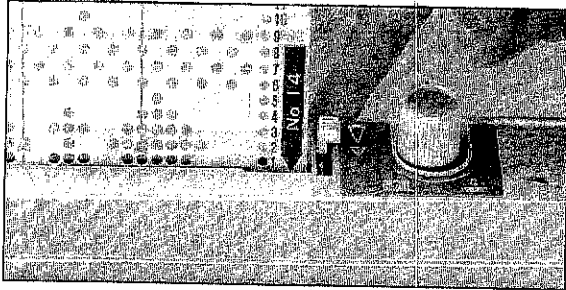

5-9. WEAVING PATTERNS

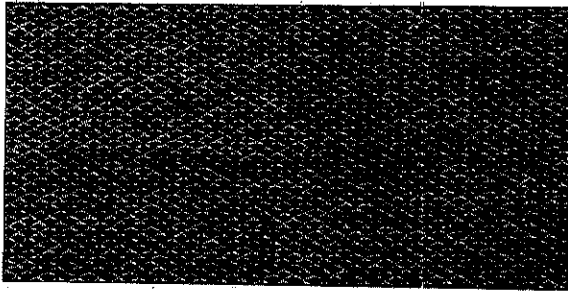

Card No. 1J Tension dial 6

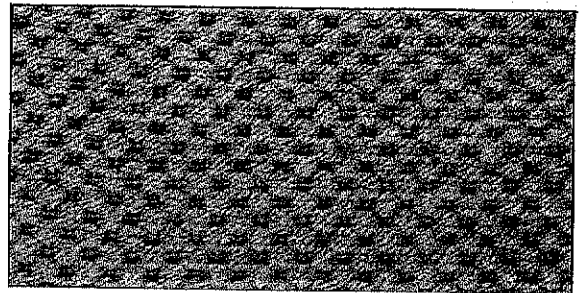

Card No. 2J Tension dial 6

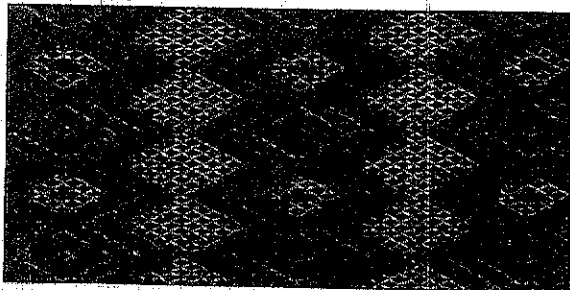

Card No. 8J Tension dial 6



Card No. 11J Tension dial 6

★ Prepare Punch card No. 8J.

★ For Weaving pattern knitting, prepare second color yarn. It is effective when medium yarn is used for the main color yarn and thick yarn for the second color.

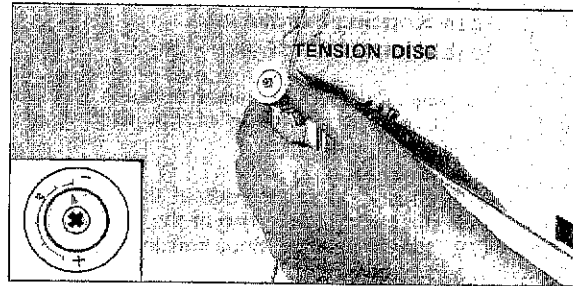

Thread main yarn and the Weaving yarn into the YARN TENSION UNIT and clip it under the YARN CLIP. Adjust the TENSION DISC. When using a thick yarn, set the "—" mark to the "▼" mark.

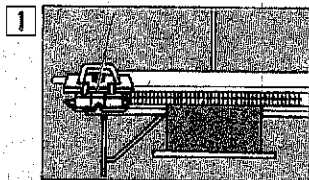

1 Knit several rows of Plain knitting at T.D. 6, and place K CARRIAGE on the left side of the machine.

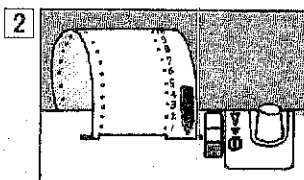

2 Set the Punch card to the starting line. Set the CARD LOCK LEVER to the "●" mark.

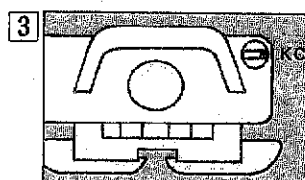

3 Set the CHANGE KNOB to the "KC" position.

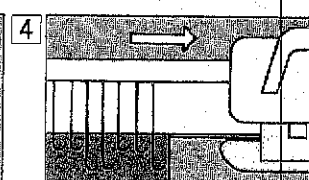

4 Move the K CARRIAGE from left to right. The needles are selected.

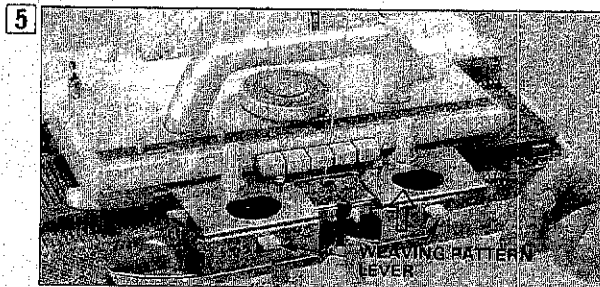

5 Set the WEAVING PATTERN LEVER to W.T. (Do not push the CAM BUTTONS.)

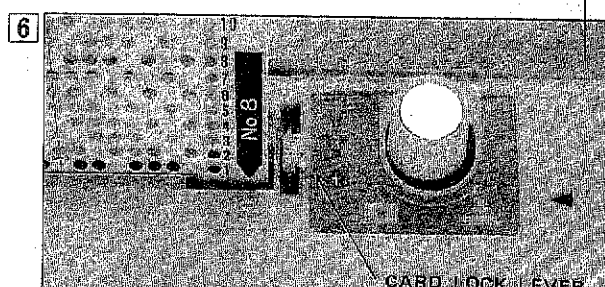

6 Set the CARD LOCK LEVER to the "▼" mark.



7 Make sure that the Weaving yarn is in the left WEAVING YARN GUIDE.

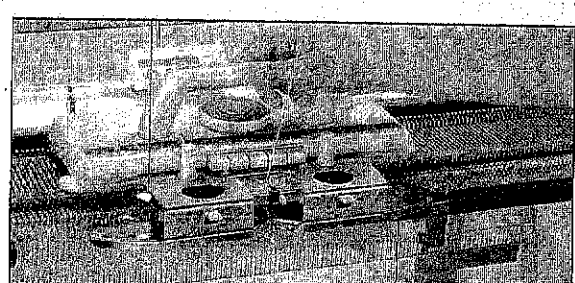

Hold the end of the Weaving yarn with your left hand. (Keep your left hand at the right edge of the knitting.) Operate the K CARRIAGE.

8

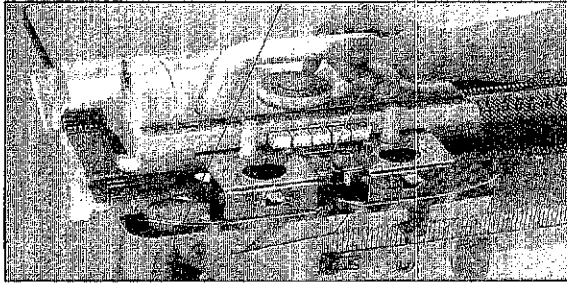

Remove the Weaving yarn from the left WEAVING YARN GUIDE.

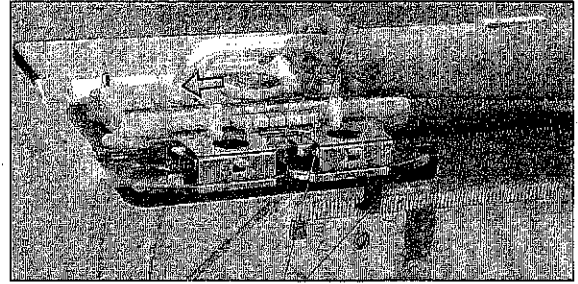

Move the K CARRIAGE slightly to the left.

9

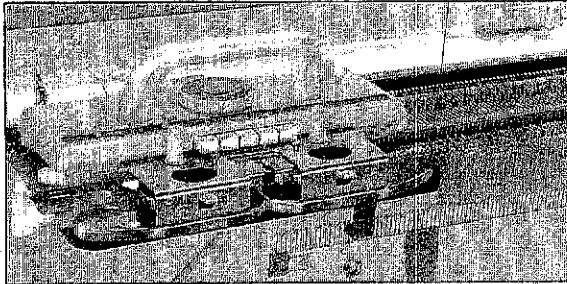

Transfer the Weaving yarn under the K CARRIAGE to the right WEAVING YARN GUIDE.

10

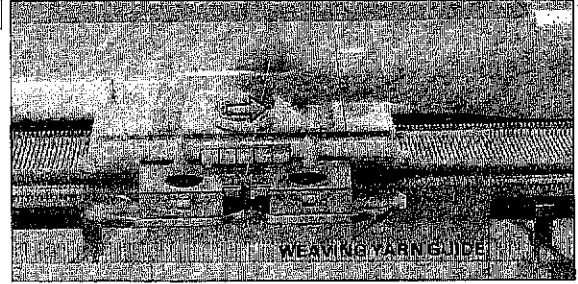

Move the K CARRIAGE to right making sure that the Weaving yarn is in the right WEAVING YARN GUIDE.

11

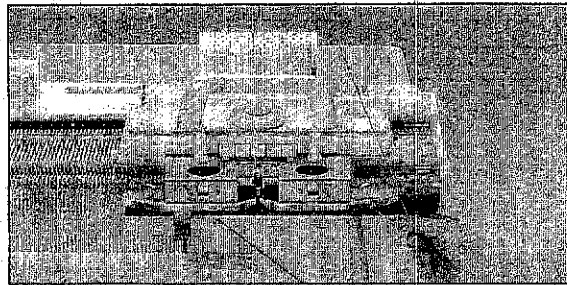

Remove the Weaving yarn from the right WEAVING YARN GUIDE.

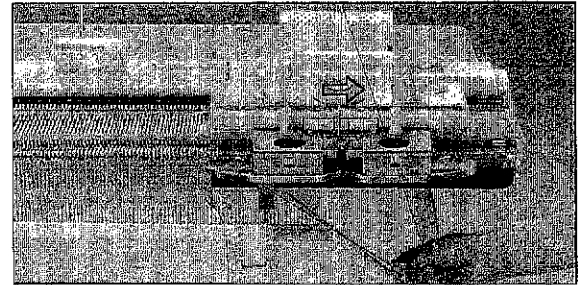

Move the K CARRIAGE slightly to the right and transfer the Weaving yarn under the K CARRIAGE and to the left WEAVING YARN GUIDE.

12

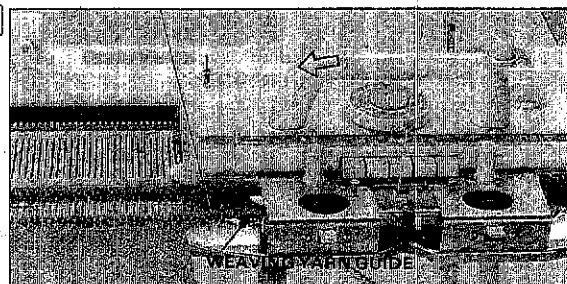

Move the K CARRIAGE to left making sure that the Weaving yarn is in the left WEAVING YARN GUIDE.

13

Repeat the procedures from 8 to 12. Then you can enjoy Weaving patterns.

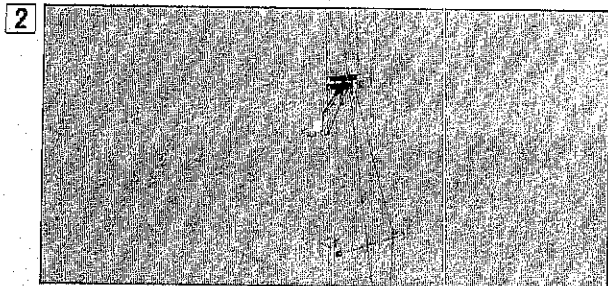

2 Thread the main and plating yarns into the YARN TENSION UNIT, and clip them under the yarn clip.

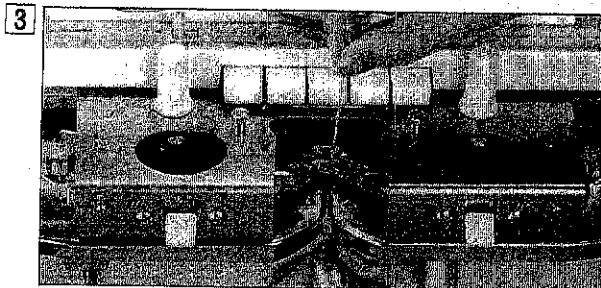

3 Thread the main yarn into the main yarn feeder. Knit several rows of plain knitting and place the K CARRIAGE on the right side of the machine.

4 Thread the plating yarn into the plating yarn feeder.

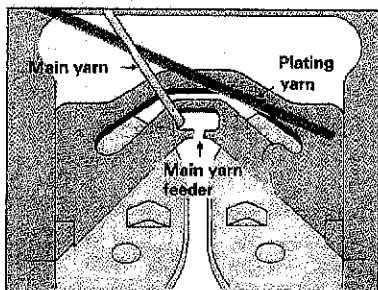

1) Pass the plating yarn behind the main yarn.

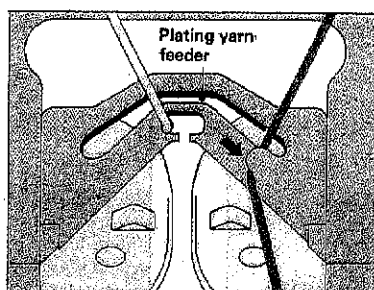

2) Thread the plating yarn into the plating yarn feeder.

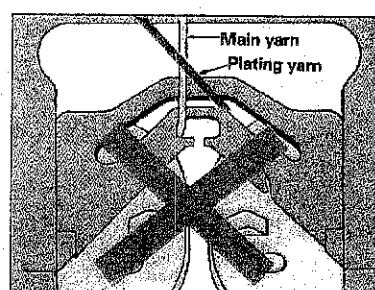

3) Make sure that two yarns do not cross.

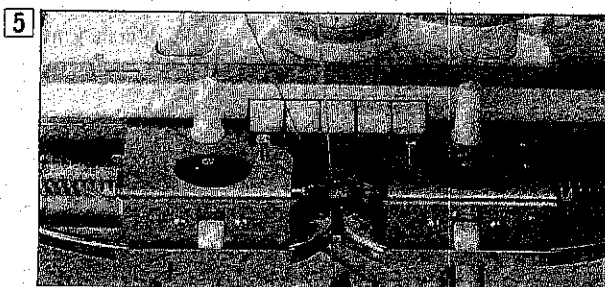

5 Hold the plating yarn under the yarn feeder with your left hand. (Keep your left hand at the right side of the knitting.)

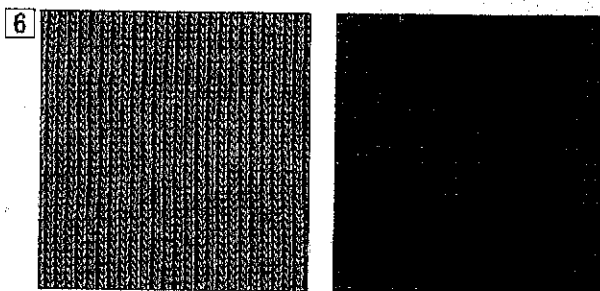

6 Continuing to operate the K CARRIAGE.

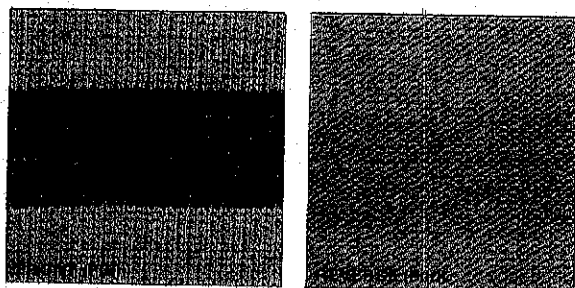

By changing the main yarn, the color of fabric will be changed.

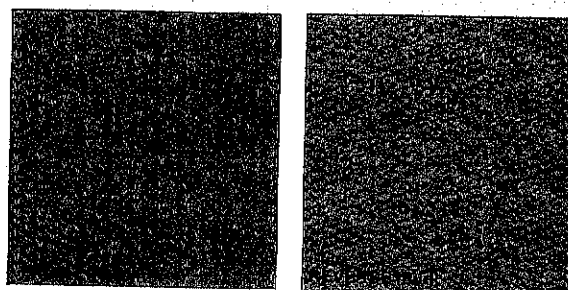

Using the punch card for Tuck stitch patterns (1J, 3J and 8J) with plating yarn knitting you can also enjoy Tuck stitch-Plating yarn knitting. (Preparation and the operation are the same as Tuck stitch pattern and Plating yarn knitting.)

5-10. PLATING YARN KNITTING

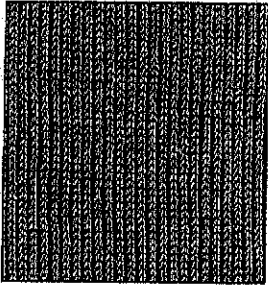

FRONT (Plain)



REVERSE (Purl)

With the PLATING YARN FEEDER it is possible to use two yarns to knit a reversible fabric with different colors on the front and reverse side.

The main yarn will appear on the front (plain) side of the fabric and plating yarn will appear on the reverse (purl) side of the fabric.

Suggested Tension Dial (T.D.) number is as follows.

Main Yarn	Plating Yarn	Suggested T.D. Number
Fine yarn	Fine yarn	6 ~ 7
Fine yarn	Very fine yarn	5 ~ 6
Very fine yarn	Fine yarn	5 ~ 6
Very fine yarn	Very fine yarn	4 ~ 5

5-10-1. Preparation for Plating yarn knitting and how to knit.

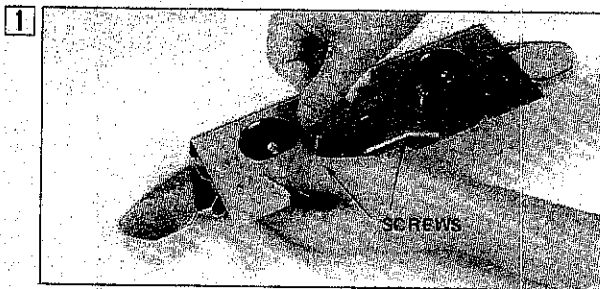

Change the yarn feeder to the PLATING YARN FEEDER by following these four (4) steps:

1) Loosen the two screws and remove the YARN FEEDER from Sinker plate assembly.

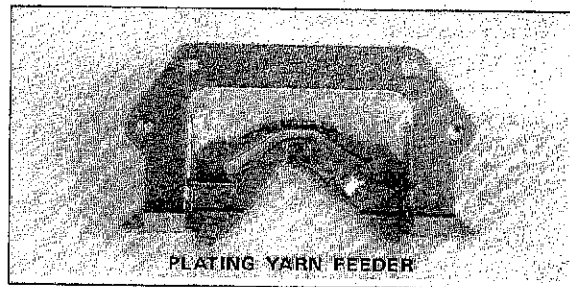

2) Take the PLATING YARN FEEDER out of the accessory box.

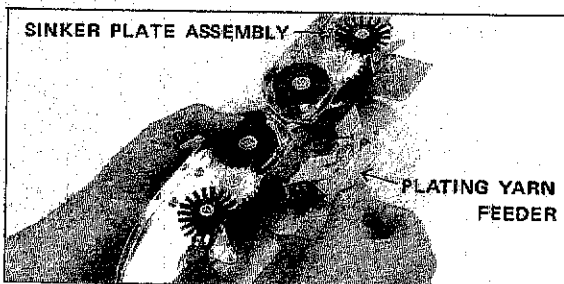

3) Set the PLATING YARN FEEDER to the Sinker plate assembly as shown in the figure.

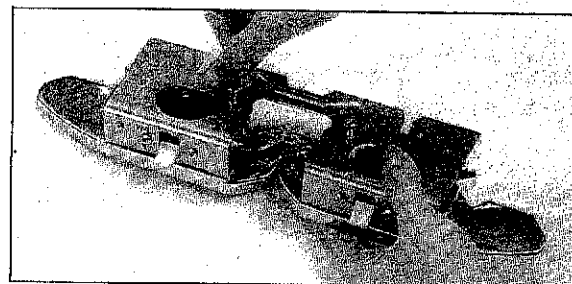

4) Then fasten the two screws.

5-11. INTARSIA KNITTING

Punch cards are not used for the Intarsia knitting.

Intarsia knitting does not traverse yarns at the back, and you can knit multi-color yarn in one row.

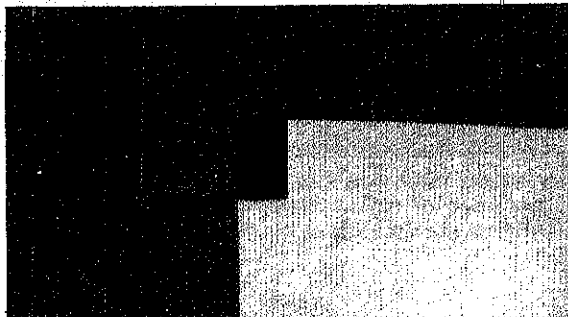

The right side of knitting (When knitting this side is away from you.)

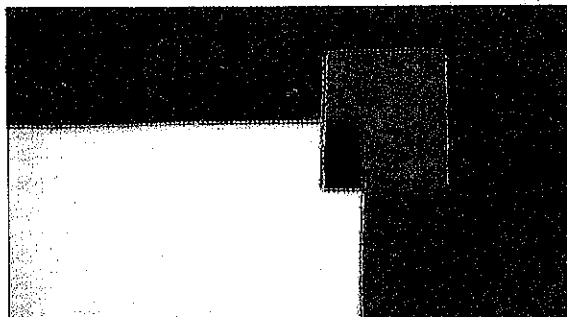

The reverse side (When knitting this side is facing you.)

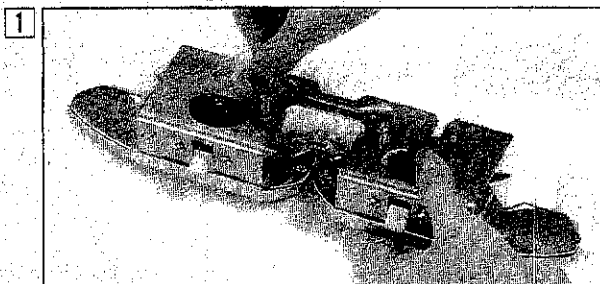

1 Change the yarn feeder to the PLATING YARN FEEDER. (See page 62)

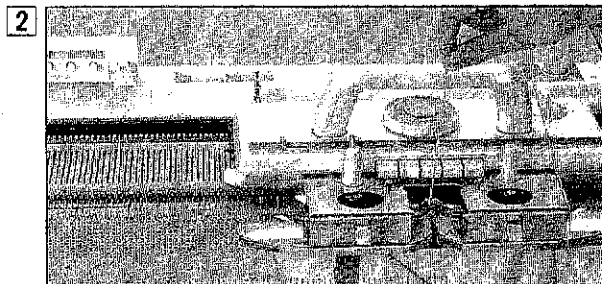

2 Knit several rows of plain knitting and place the K CARRIAGE on the right side of the machine. Take the yarn out of the YARN TENSION UNIT. (The yarn tension unit is not used for the Intarsia knitting.)

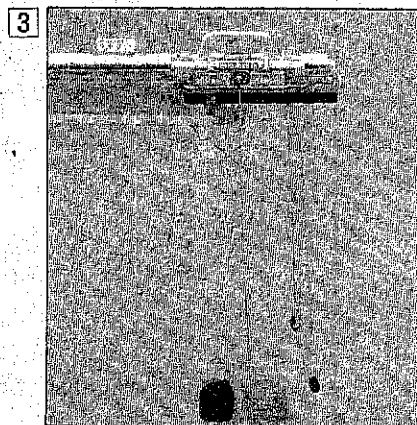

3 Place the main (A) and contrast yarns (A' (B) and (C) at your feet. (Leave the main yarn (A) in the main yarn feeder.)

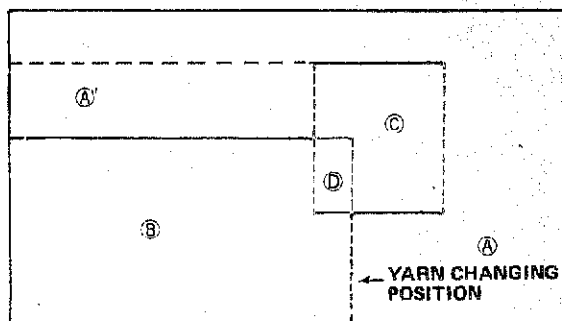

----- : Yarn changing position

Part (A) : Knit with color A

Part (A') : Knit with color A

Part (B) : Knit with color B

Part (C) : Knit with color C

Part (D) : Knit with color D

Note:

Prepare color A yarn separately for the part (A)

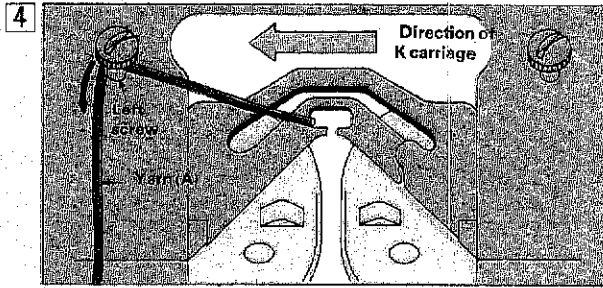

4 Hang yarn (A) on the left SCREW as shown in the figure, and pull the yarn gently to give a slight tension. Then move the K CARRIAGE to left.

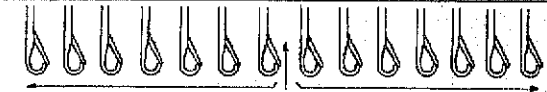
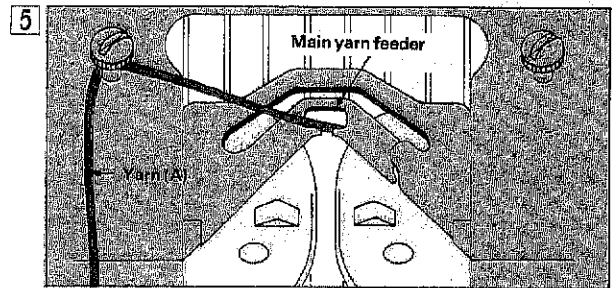

Part (B) Yarn changing position Part (A)

Stop the K CARRIAGE at the position where you are going to change the color of yarn. The yarn changing position is just center between two needles.

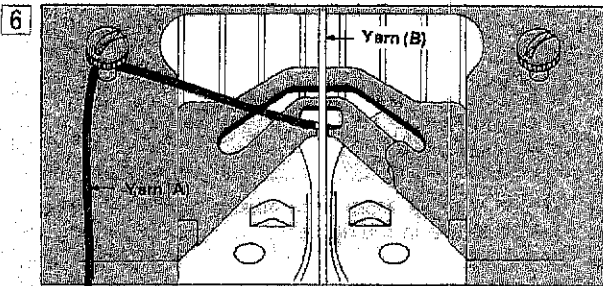

6 Thread yarn (B) into the main yarn feeder and hang it on the left SCREW as shown in the figure.

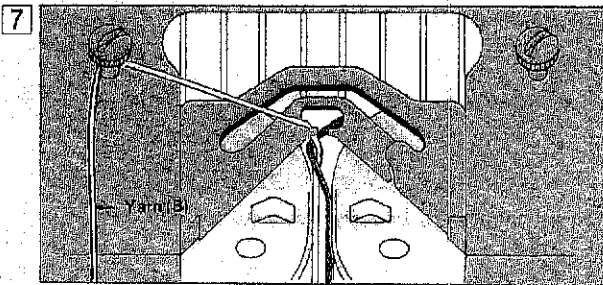
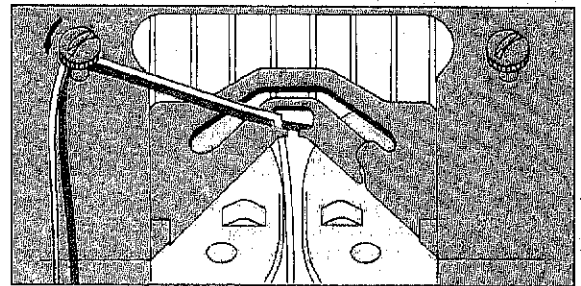

7 Remove yarn (A) from yarn feeder and let it hang down.

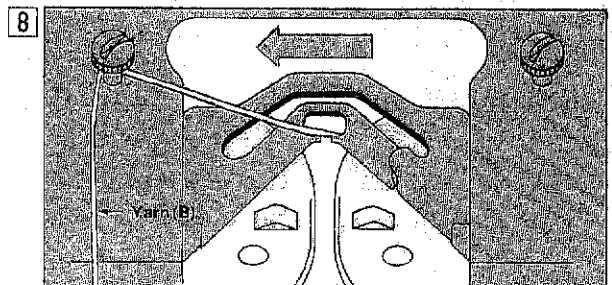

8 Pull yarn (B) gently and move the K CARRIAGE to left. (Do not pull the yarn too tightly). When you are going to knit using more than one color in one row, repeat steps 6-8.

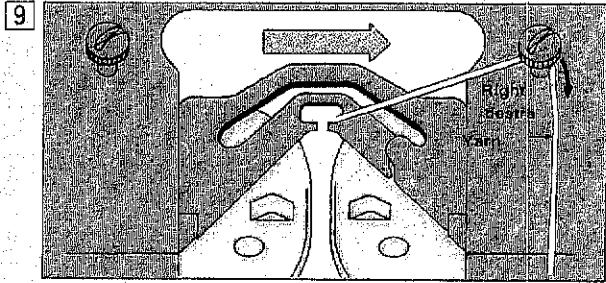

9 After knitting one row, hang yarn B on the right SCREW as shown in the figure. Pull yarn B gently and move the K CARRIAGE to right.

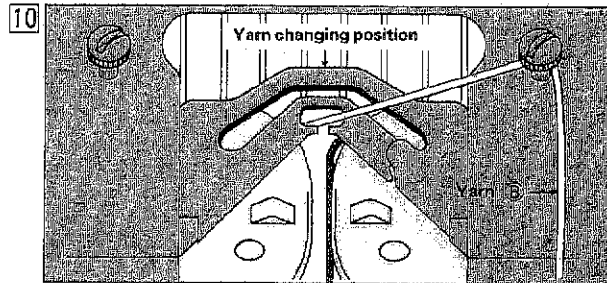

10 Stop the K CARRIAGE at the position where you are going to change the color of yarn. The changing position is just center between two needles.

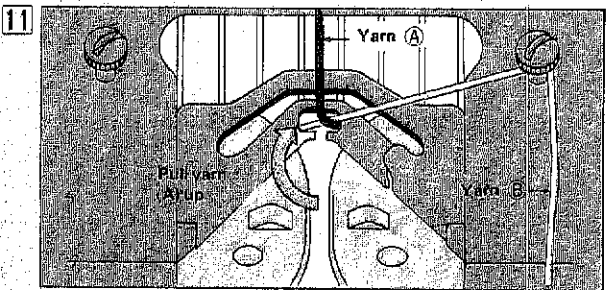

11 Cross yarn A and yarn B at the changing position to avoid making a hole on the knitting.

1) Pull yarn A as shown in the figure.

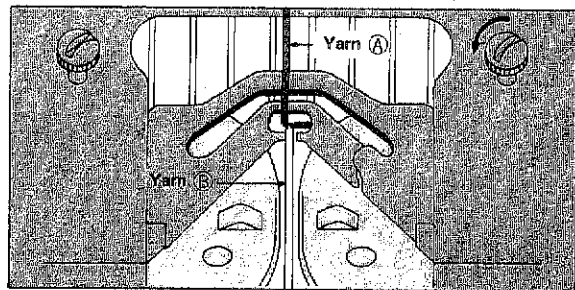

2) Remove yarn B from yarn feeder and let it hang down as shown in the figure.

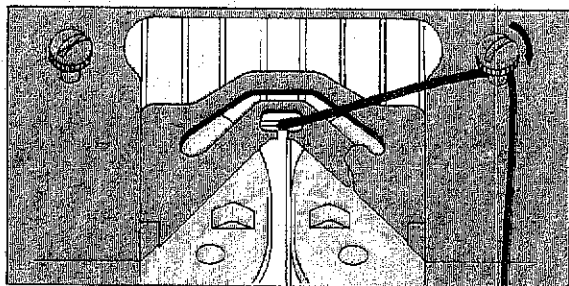

3) Hang yarn A on the right SCREW, and move the K CARRIAGE to right.

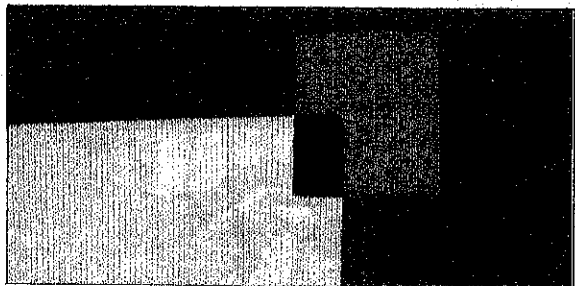

Repeat these steps in each row, now Intarsia knitting is completed.

5-12. HOW TO DESIGN OWN PUNCH CARDS

Although there are 20 different punch cards with your machine, you can enjoy many other patterns by using the PATTERN BOOK that is available separately.

1. Select a pattern you wish to knit.
Then mark on the BLANK CARD according to the pattern.
2. Punch out the marked blocks on the card by using the CARD PUNCHER that is available separately.

When you punch holes by mistake, you can mend the card with tape.

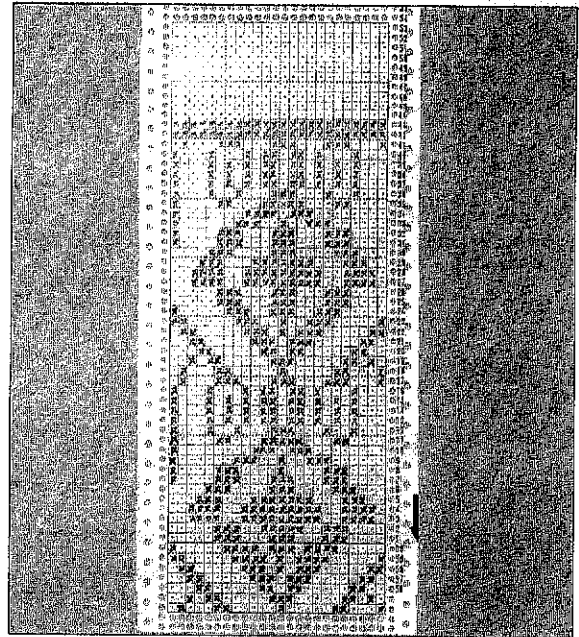
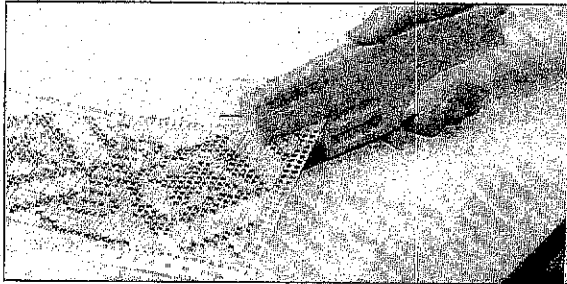

PRE-PUNCHED CARD

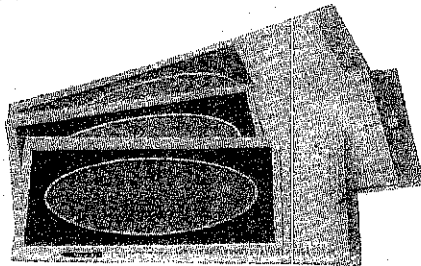

PATTERN BOOK Vol. 3

CARD PUNCHER

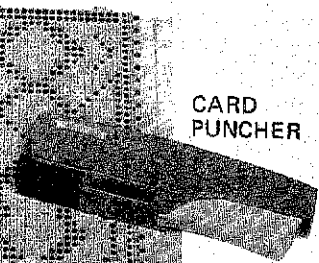

BLANK CARD

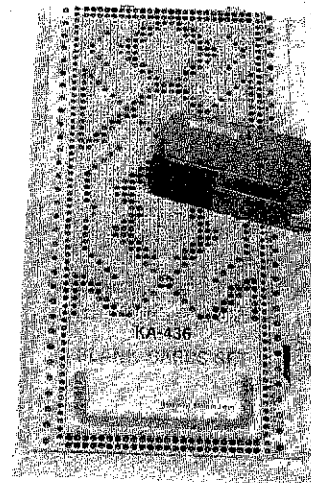

BLANK CARDS, CARD PUNCHER, PATTERN BOOK Vol. 3 and PRE-PUNCHED CARDS (Vol. 1, 2, 5, 6, 7, 8, 9, 10, 11, 12 and 13) are available separately.

You can design your own patterns by marking and punching the card in the same manner.

6. KNOWLEDGE OF PATTERN KNITTING

6-1. IF YOU MAKE MISTAKES IN PATTERN KNITTING USING THE PUNCH CARDS . . . HOW TO CORRECT THEM.

6-1-1. If the K carriage should jam.

Do not move the K CARRIAGE by force. Remove it, then start knitting again from the beginning of the row.

1

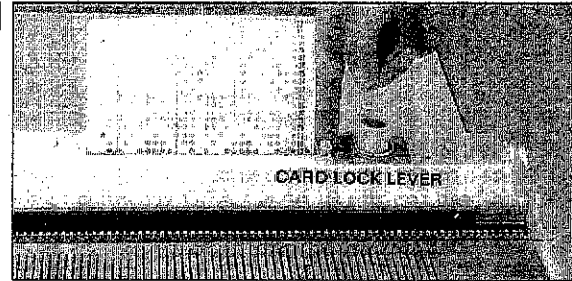

Set the CARD LOCK LEVER to the "●" mark.

2

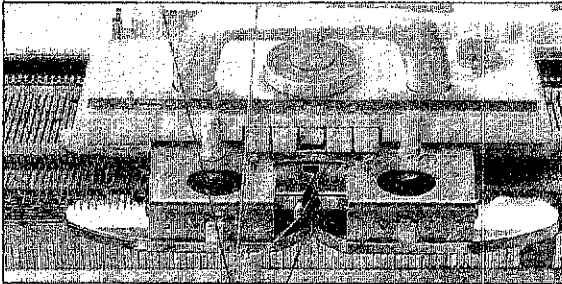

1) Take the yarn out of the YARN FEEDER. When knitting Fair-isle patterns or Weaving patterns, take the second color yarn out of the YARN FEEDER, also.

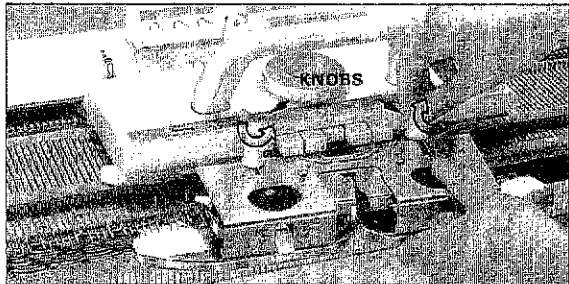

2) Loosen the KNOBS and remove the SINKER PLATE ASSEMBLY from the K CARRIAGE.

3

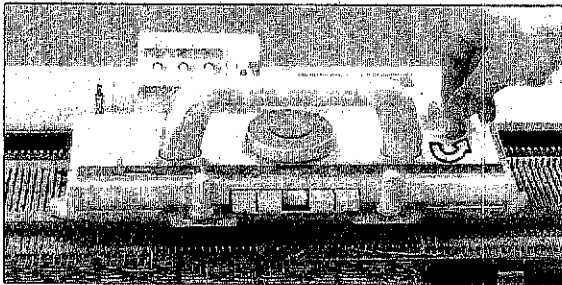

Set the CHANGE KNOB to position CR to release the K CARRIAGE from the machine.

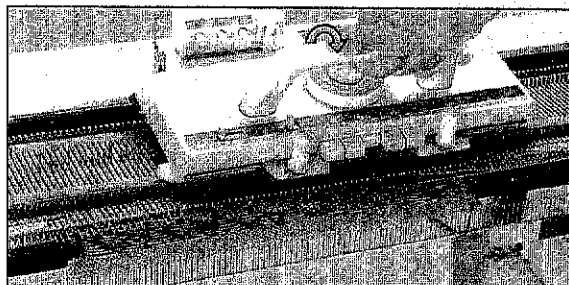

Lift up the K CARRIAGE to remove.

4

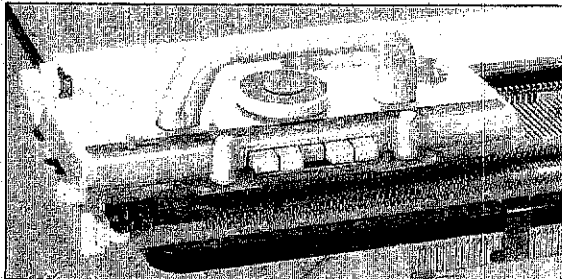

Place the K CARRIAGE on the machine at the side toward which the K CARRIAGE was moved.

5

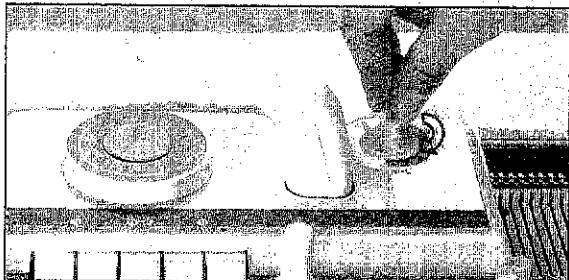

1) Set the CHANGE KNOB to position N.L. The CAM BUTTONS will be restored automatically.

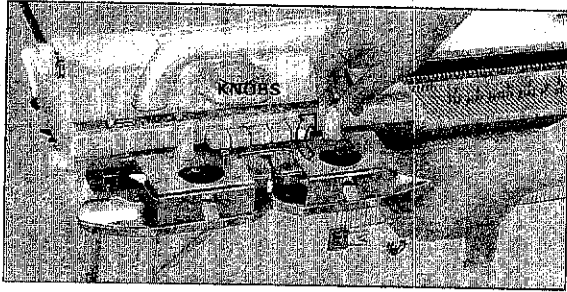

2) Return the SINKER PLATE ASSEMBLY to the K CARRIAGE.

6

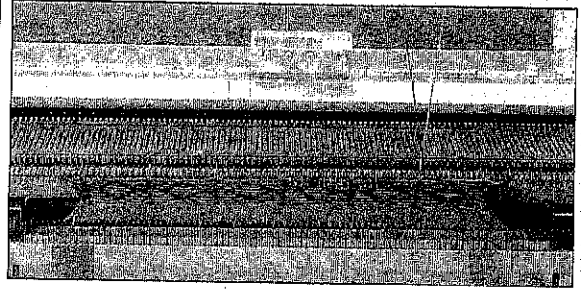

Unravel a row of knitting.

1) Using the TRANSFER TOOL, transfer the stitches on the stem of the needle to the HOOK of the needle so they will not drop.

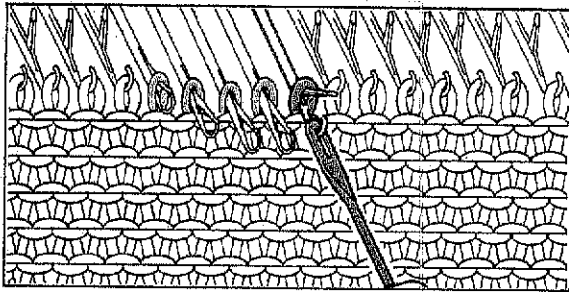

1-1). Place the EYE of the TRANSFER TOOL into the HOOK of the needle.

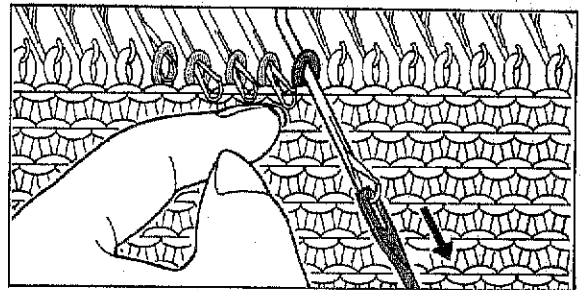

1-2) Hold the TRANSFER TOOL parallel with the needle and pull it toward you.

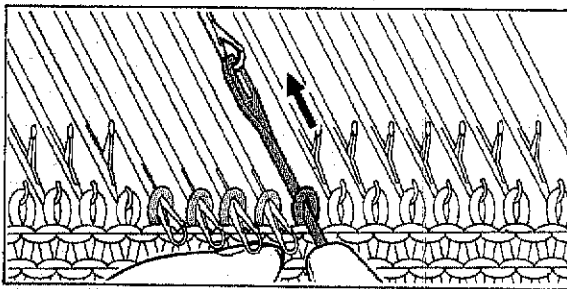

1-3) Push the TRANSFER TOOL toward the machine until the stitch is on the stem of the transfer tool.

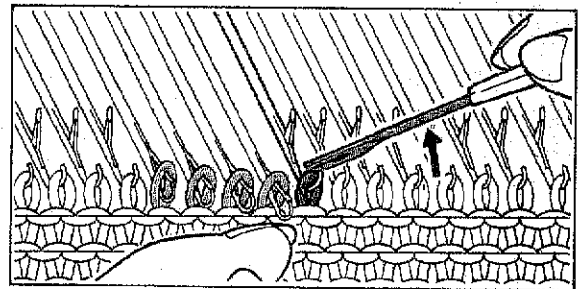

1-4) Transfer the stitch on the TRANSFER TOOL to the HOOK of the needle.

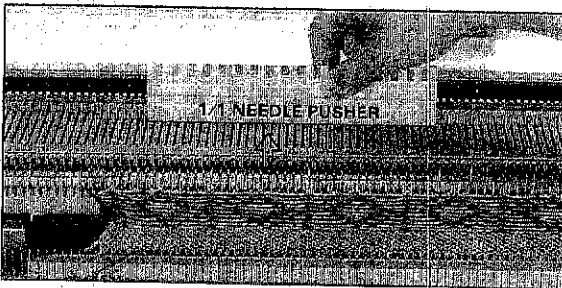

1-5) After transferring each stitch to the hook of a needle, bring back the needles using the 1/1 NEEDLE PUSHER.

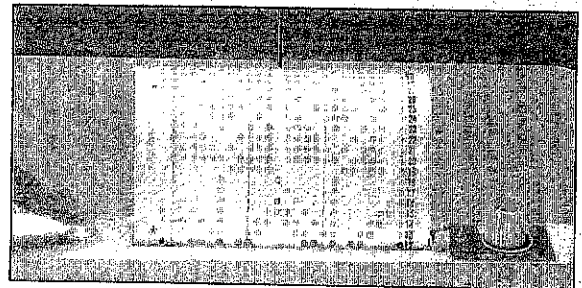

If some needles are caught and sink down, push the Button beside the punch card. The needles return back to normal height.

2) Unravelling a row of knitting.
 When knitting Fair-isle patterns or Weaving patterns,
 unravel the second color yarn, too.

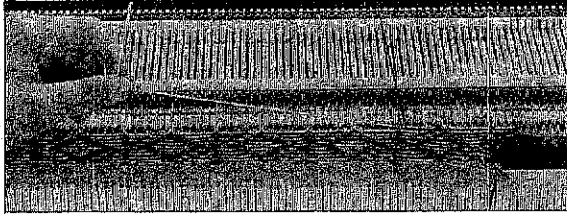

2-1) Hold the main yarn parallel with the GATE PEGS.

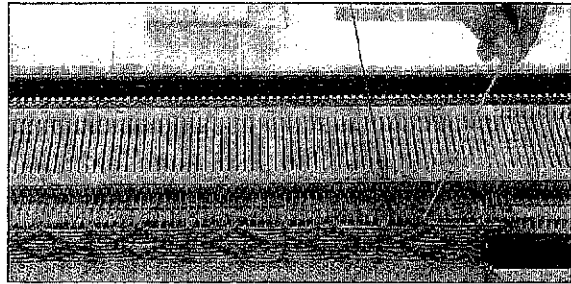

2-2) Pull the main yarn slightly sideways and up to unravel the knitting.

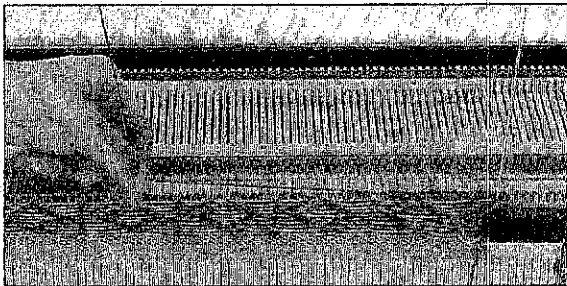

Unravel the second color yarn in the same way as the main yarn.

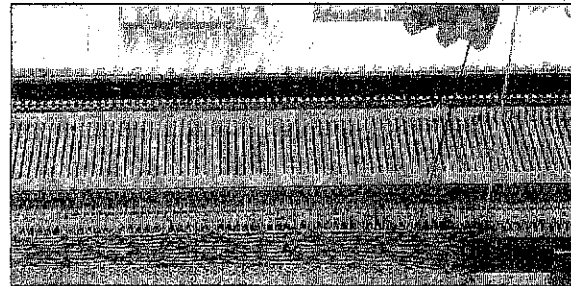

2-4) Pull the unravelled yarn down from under the REAR YARN GUIDE to take up the slack.

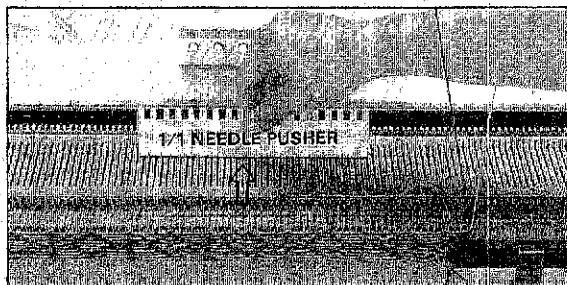

2-3) After unravelling the knitting, make sure that the stitches are on the hooks of the needles and return the needles to position B by using the 1/1 NEEDLE PUSHER.

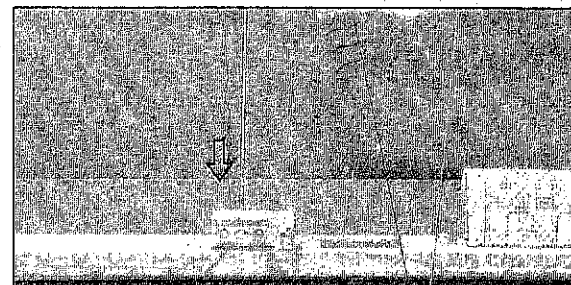

When unravelling several rows of knitting, repeat the procedures 2-1 – 2-4. Unravel the knitting as the yarn comes to the opposite side of the K CARRIAGE.

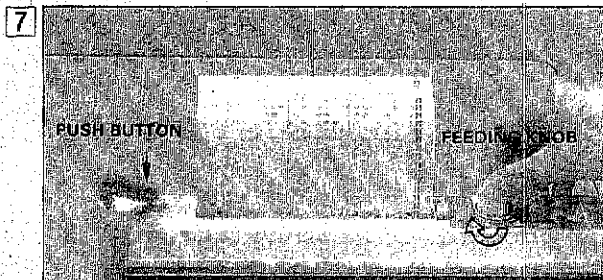

7 Rewind the PUNCH CARD the same number of rows as unraveled. Set the card lock lever to "●"

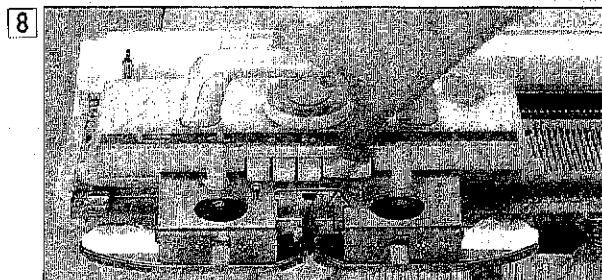

8 To select the needles, depress both "PART" buttons and set the CHANGE KNOB to K C.

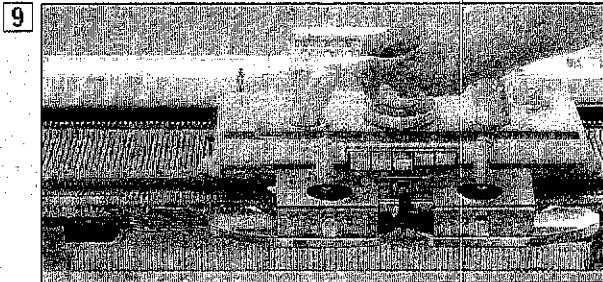

9 Operate the K CARRIAGE.
At this time, the yarn is not in the yarn feeder.

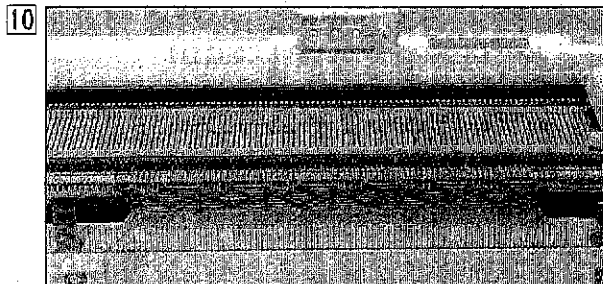

10 Position B needles are selected.

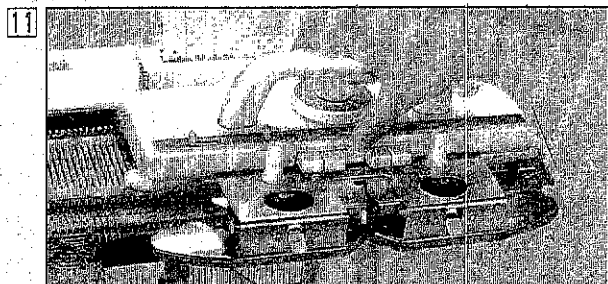

11 Push a cam button according to the pattern you are going to knit.



12 Set the CARD LOCK LEVER to the "▼" mark.

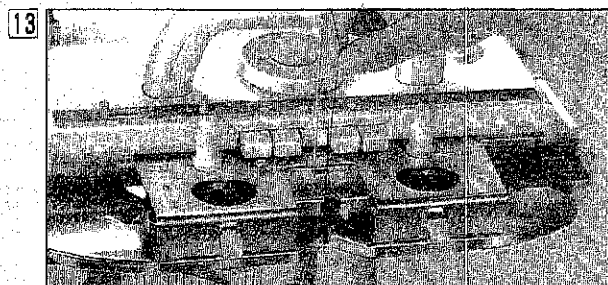

13 Thread the yarn into the YARN FEEDER and start knitting again.
When knitting, Fair-isle patterns or Weaving patterns, do not forget to thread the second color yarn.

If the CARRIAGE has not started to knit yet, but the PUNCH CARD has been rotated.

Do not move the CARRIAGE.
Set the CARD LOCK LEVER to "●".

- 1) Unravel the incorrect rows.
- 2) Rewind the PUNCH CARD in the same number of the rows as unravelled, and one step more.
- 3) The other operations are the same as explained above.

If you want to move the CARRIAGE without knitting, you must set the CHANGE KNOB to "N-L" and push in both "PART" buttons.

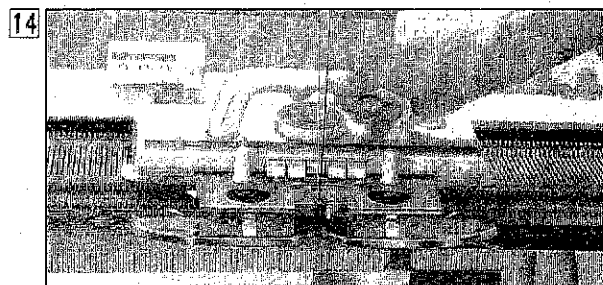

14 Operate the K CARRIAGE pulling the yarn slightly up.

If the Carriage has not started to knit yet, and the PUNCH CARD has not rotated.

Do not move the CARRIAGE.
Set the CARD LOCK LEVER to "●".

- 1) Unravel the incorrect rows.
- 2) Rewind the PUNCH CARD in the same number of rows as unravelled.
- 3) The other operations are the same as explained above.

**6-2. IF YOU MAKE MISTAKES ON
KNITTING DOUBLE LENGTH
PATTERNS . . .
HOW TO CORRECT THEM.**

**Correct the mistakes in the
same way as
Pattern Knitting previously
instructed.**

Reset the PUNCH CARD according to the right table.

When you unravel the knitting, the K CARRIAGE and
the yarn must be on the opposite side.

In case the K CARRIAGE has not started to knit yet,
but the PUNCH CARD has been rotated, rewind the
PUNCH CARD according to the right table and one step
in addition.

In Case the Carriage has started Knitting.

Number of Rows to	Direction of Carriage	Direction of Knitting
1	Right	Right
2	Left	Left
3	Right	Right
4	Left	Left
5	Right	Right
6	Left	Left
7	Right	Right
8	Left	Left
9	Right	Right
10	Left	Left
11	Right	Right
12	Left	Left
13	Right	Right
14	Left	Left
15	Right	Right
16	Left	Left
17	Right	Right
18	Left	Left
19	Right	Right
20	Left	Left
21	Right	Right
22	Left	Left
23	Right	Right
24	Left	Left
25	Right	Right
26	Left	Left
27	Right	Right
28	Left	Left
29	Right	Right
30	Left	Left
31	Right	Right
32	Left	Left
33	Right	Right
34	Left	Left
35	Right	Right
36	Left	Left
37	Right	Right
38	Left	Left
39	Right	Right
40	Left	Left
41	Right	Right
42	Left	Left
43	Right	Right
44	Left	Left
45	Right	Right
46	Left	Left
47	Right	Right
48	Left	Left
49	Right	Right
50	Left	Left
51	Right	Right
52	Left	Left
53	Right	Right
54	Left	Left
55	Right	Right
56	Left	Left
57	Right	Right
58	Left	Left
59	Right	Right
60	Left	Left
61	Right	Right
62	Left	Left
63	Right	Right
64	Left	Left
65	Right	Right
66	Left	Left
67	Right	Right
68	Left	Left
69	Right	Right
70	Left	Left
71	Right	Right
72	Left	Left
73	Right	Right
74	Left	Left
75	Right	Right
76	Left	Left
77	Right	Right
78	Left	Left
79	Right	Right
80	Left	Left
81	Right	Right
82	Left	Left
83	Right	Right
84	Left	Left
85	Right	Right
86	Left	Left
87	Right	Right
88	Left	Left
89	Right	Right
90	Left	Left
91	Right	Right
92	Left	Left
93	Right	Right
94	Left	Left
95	Right	Right
96	Left	Left
97	Right	Right
98	Left	Left
99	Right	Right
100	Left	Left

7-1. LACE PATTERN KNITTING

1. L CARRIAGE

You can select the needles and transfer the stitches automatically by using the L CARRIAGE.

LACE CHANGER LEVER

- N Normal lace pattern knitting.
- F Fine-lace pattern knitting.

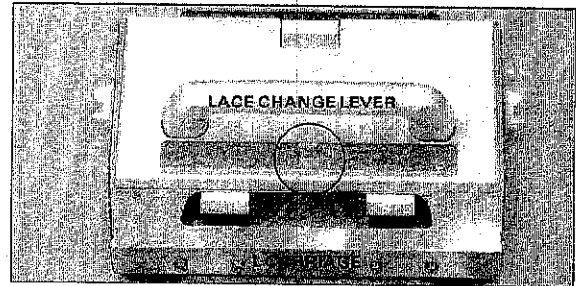

Lace Patterns

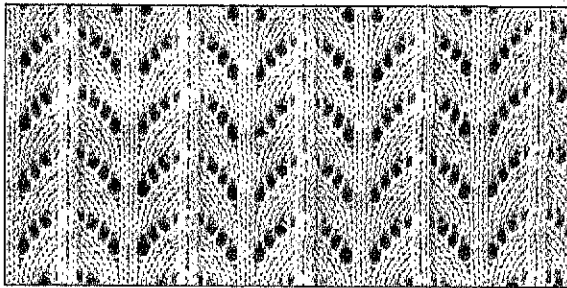

Card No. 18J Tension Dial 6

Fine-Lace Patterns

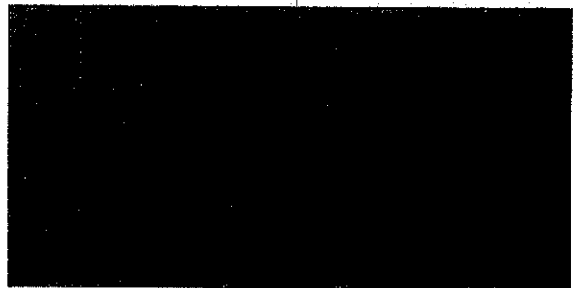

Card No. 18J Tension Dial 8

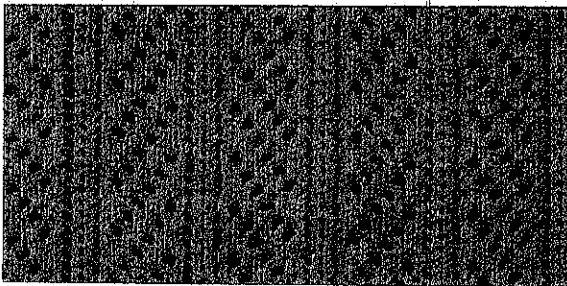

Card No. 20J Tension Dial 6

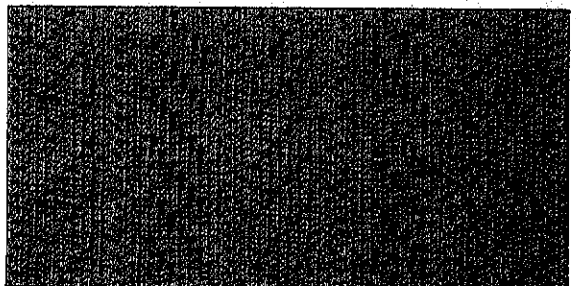

Card No. 20J Tension Dial 7

7-2. HOW TO SET THE L CARRIAGE

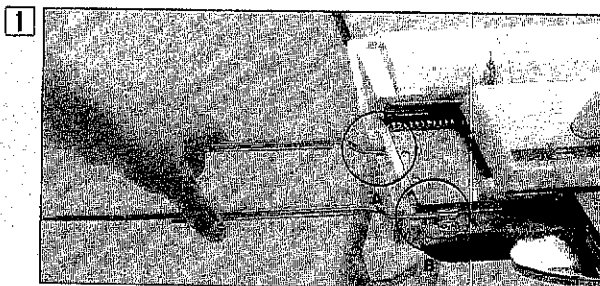

Insert the EXTENSION RAILS into the holes (A and B) at both sides of the machine to avoid dropping of the L CARRIAGE.



Remove the L CARRIAGE from the carrying case, by depressing the SPRING.



3 Push the **RELEASE BUTTON** to remove the **L CARRIAGE**.

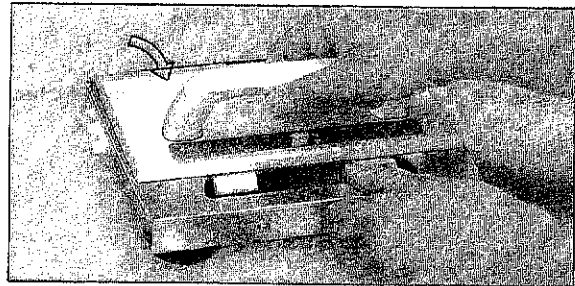

Then set up the **L CARRIAGE HANDLE**.

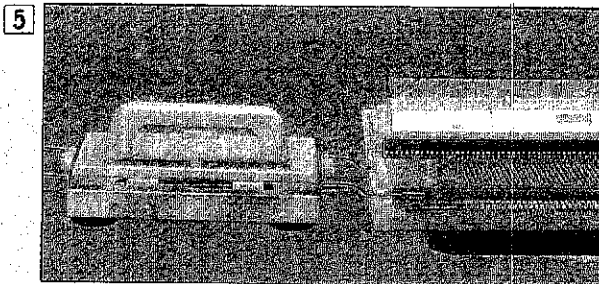

5 Push the **Release button** and place the **L CARRIAGE** securely on the left side **EXTENSION RAIL**.

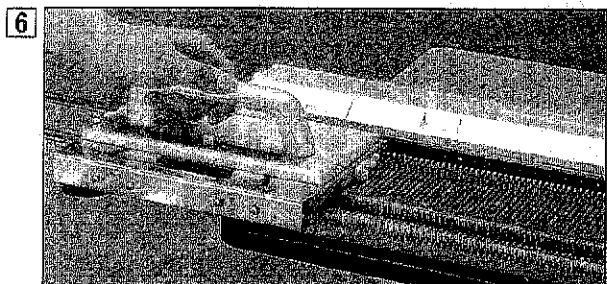

6 Slide the **L CARRIAGE** onto the **NEEDLE BED** and make sure that the **L CARRIAGE** is set correctly.

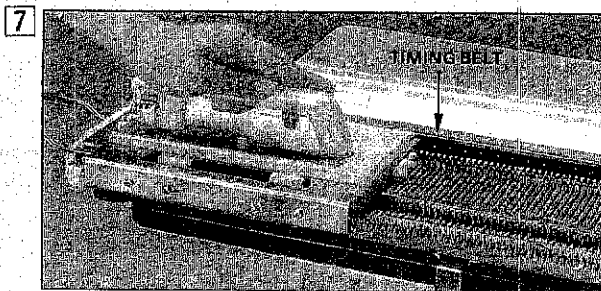

7 The **TIMING BELT** must move by moving the **L CARRIAGE**.

7.3. LACE PATTERN KNITTING FINE-LACE PATTERN KNITTING

- ★ Prepare the **Punch card No. 20J** and medium thickness yarn.
- ★ Thread yarn into the **Yarn tension unit**.

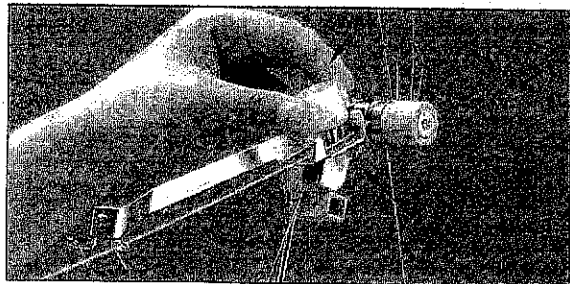

When you start **Lace pattern knitting**, set the **WAX** on the **WAX STAND**.

1

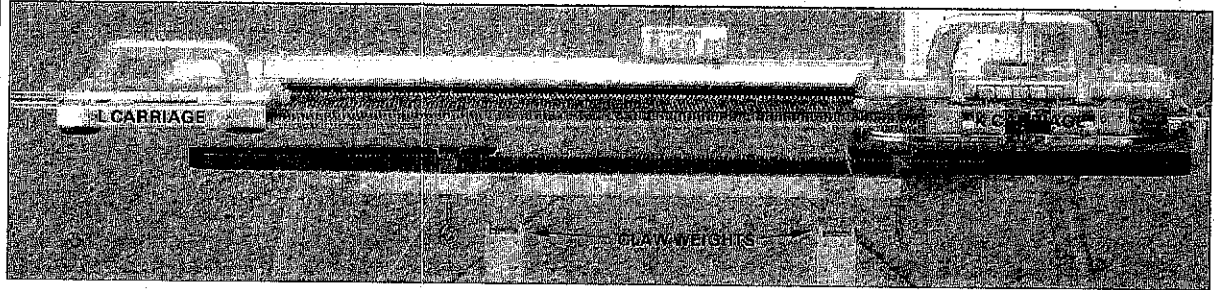

Knit several rows of plain Knitting with the K CARRIAGE and put it on the right side of the machine. Hang the CLAW WEIGHTS onto the CAST-ON COMB (as shown in the figure) to avoid dropping stitches.

2

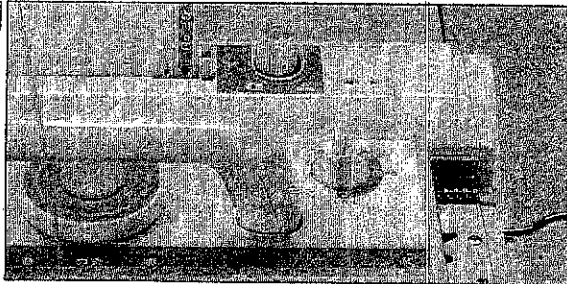

Set the PUNCH CARD. Set the card lock lever to "●". Make sure that the CHANGE KNOB of the K CARRIAGE is set to position N-L.

3

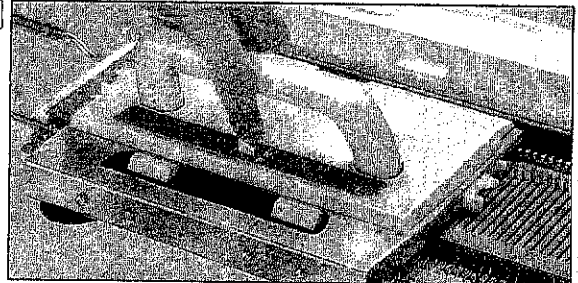

Set the LACE CHANGE LEVER to position N or F according to the pattern you are going to knit.

N..... Normal lace pattern knitting.

F..... Fine-lace pattern knitting.

4

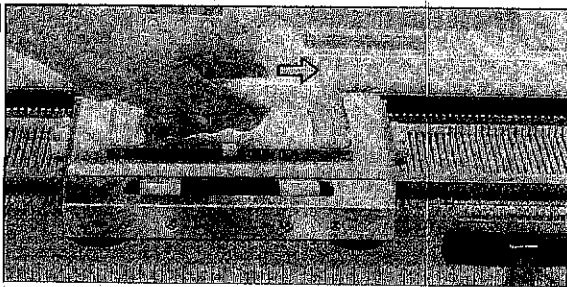

Move the L CARRIAGE to right.

5

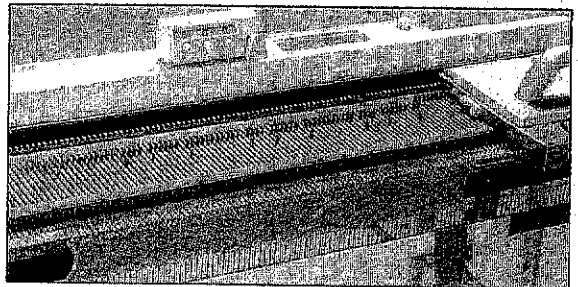

Position B needles are selected by L CARRIAGE.

Note: Both end needles remain in position B regardless of the Punch card. This is called "NON-SELECTION MECHANISM" for end needles.

NON-SELECTION MECHANISM

- ★ The needles corresponding to holes on the punch card are selected to position D by moving the L CARRIAGE
- ★ Since "NON-SELECTION MECHANISM" for end needles is installed in the L CARRIAGE both end needles remain in position B regardless of the punch card.

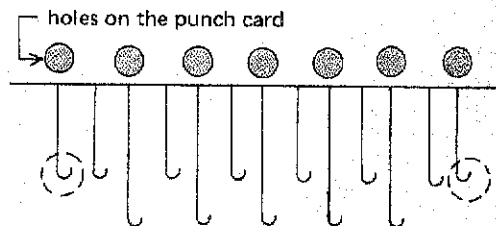

6

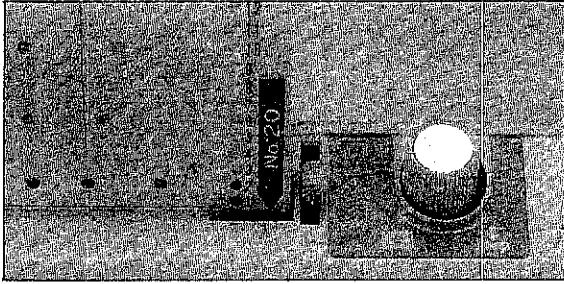

Set the CARD LOCK LEVER to the "▽" mark.

7

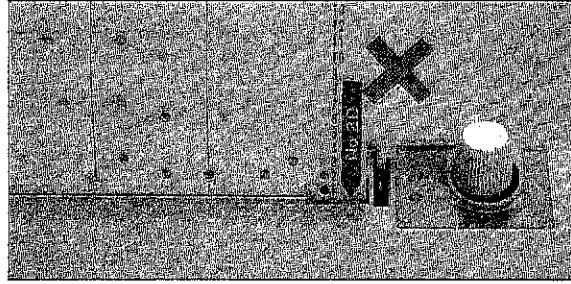

When knitting Lace patterns or Fine-Lace patterns do not set the CARD LOCK LEVER to the "▽" mark.

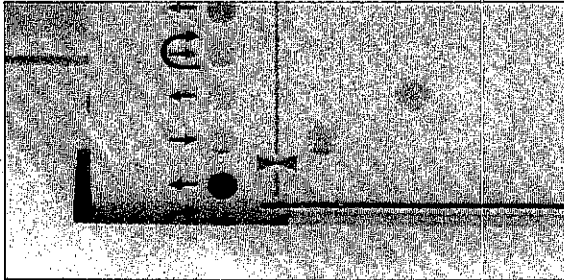

1) Move the L CARRIAGE from right to left.

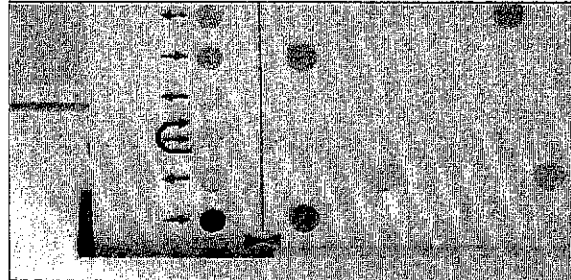

2) Move the L CARRIAGE from left to right.

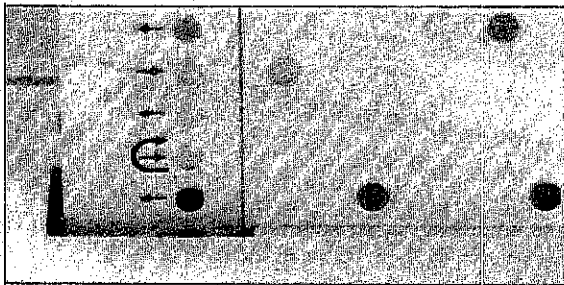

3) Move the L CARRIAGE from right to left.

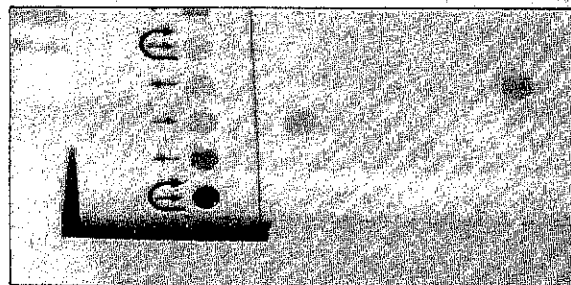

4) Move the K CARRIAGE from right to left and come back to right side of the machine, and move the L CARRIAGE from left to right.

- ★ When the symbol \ominus is indicated, first move the K CARRIAGE, then operate the L CARRIAGE.
- ★ When you operate the K CARRIAGE, the L CARRIAGE is always on the left side of the machine.

TO FINISH PATTERN KNITTING

When the latest \ominus mark below the Starting line comes at the Card inlet, the lace pattern is completed. Set the Card lock lever at the "●" mark and knit several rows of plain stitch.

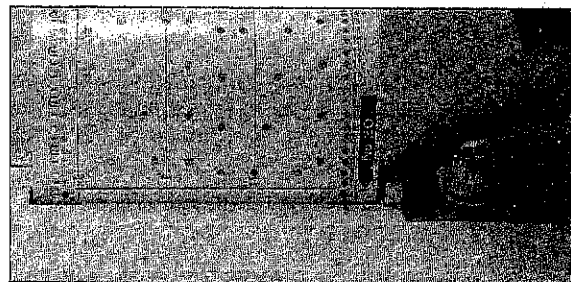

7-4. WHEN KNITTING LACE AND FINE-LACE PATTERNS MIXED

★ By changing the setting of Lace change lever on the L CARRIAGE according to the arrows (→ and ↗) on Punch card, you can knit mixed lace pattern.

★ Prepare Punch card No. 19J.

(How to knit)

Before starting to knit mixed lace pattern, decide the setting of Lace change lever for the arrows on the Punch card, namely set the Lace change lever at the position N for the arrow → and F for ↗ or vice versa.

Operation is the same as for Lace knitting (See P. 74)

* Example A

→ : N, ↗ : F

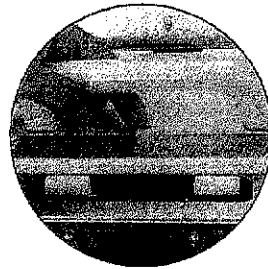
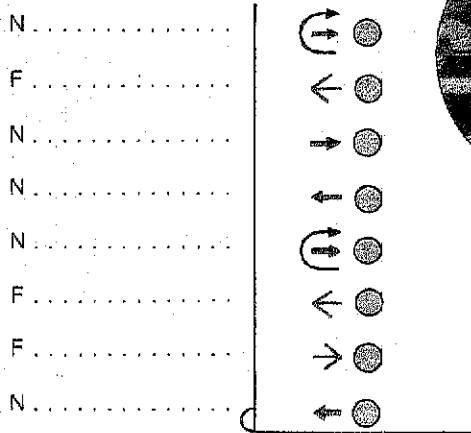

* Example B

↗ : N, → : F

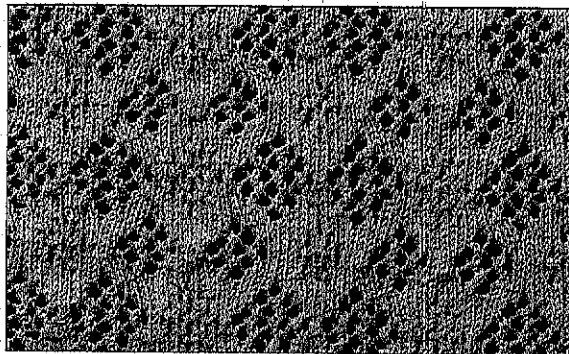
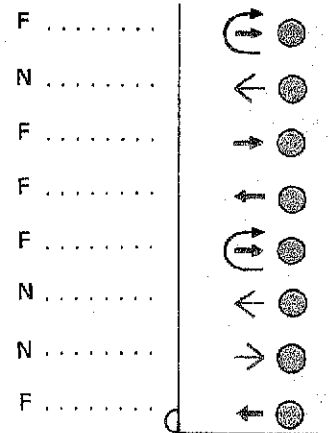

(→ = N, ↗ = F)

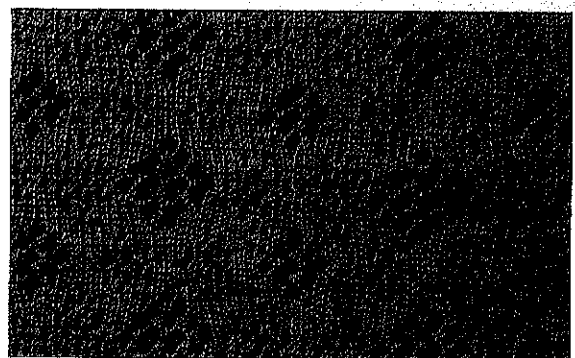

(↗ = N, → = F)

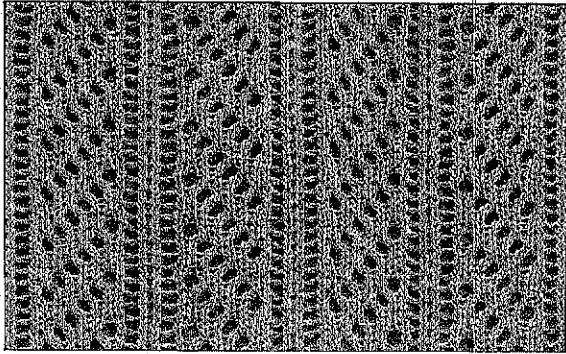

Card No. 16J Normal Lace Pattern

L-point Cam

For 4-needle

For 8 needle

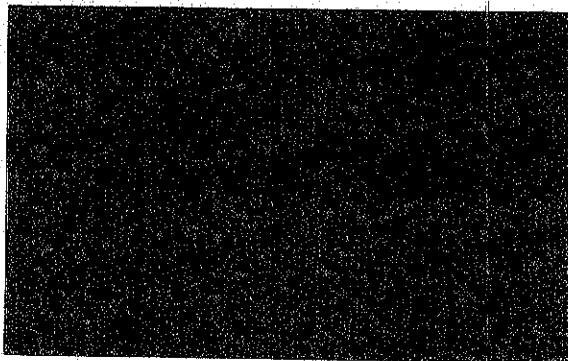
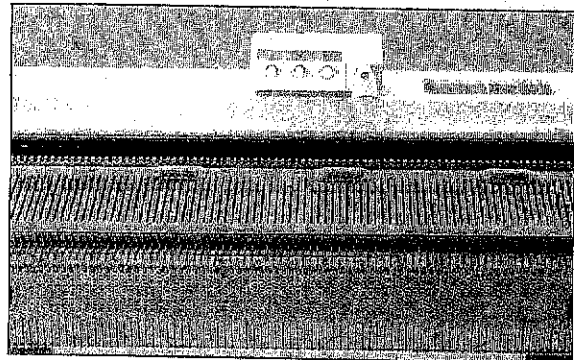
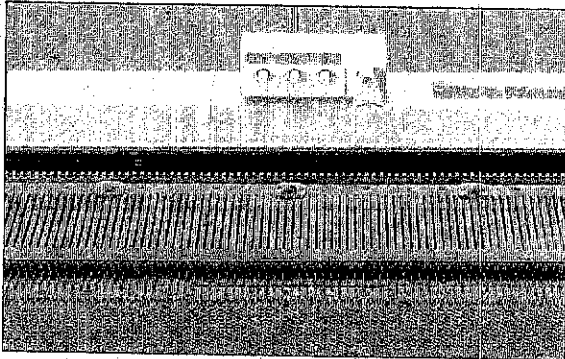
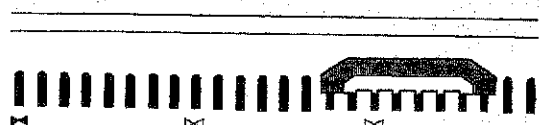

(A)

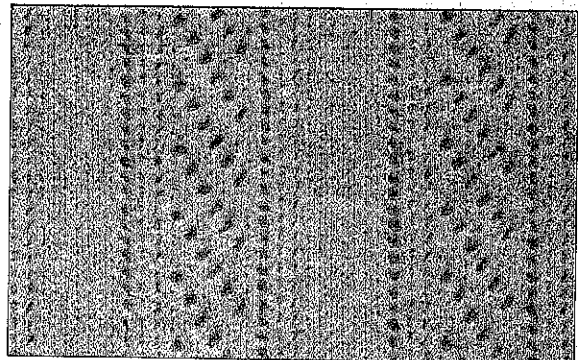

(B)

★ By placing the L-point cam on the needle bed, needles which correspond to the L-point cam are not selected to position D. Therefore these needles knit the Plain stitches.

How to use the L-Point cam

- There are two different cams which are for 4 needles and 8 needles width.
- You can combine the L-point cam according to the width of plain stitch on your design.
- Punch card No. 16J to 20J can be used.

* The L-point cam can not be used for the Fair-isle motif knitting by using the K CARRIAGE, therefore remove the L-point cam after knitting the Lace pattern.

How to place the L-point cam

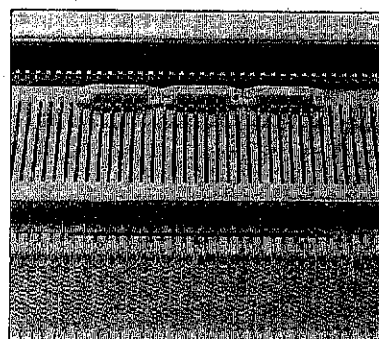
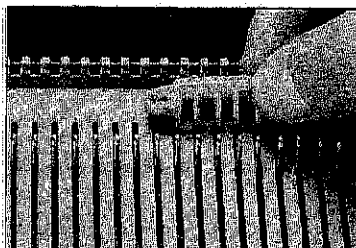
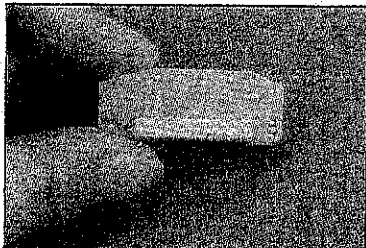

- 1 Decide the position where you want to knit with plain stitch.
- 2 Hold the L-point cam, pegs being lower side and ► mark on the left side.
- 3 Adjust the ► mark on the L-point cam to the same mark on the Rear rail of needle bed and insert the pegs into grooves of needle bed.
(You can place the L-point cam without adjusting the ► mark, see example D).
- 4 Other operations are the same as for Lace knitting.

You can combine any number of L-point cam and place them anywhere according to your design.

★ Move the Lace Carriage slowly while the L-point cam being used.

8 KNOWLEDGE OF LACE PATTERNS

8-1. IF THE L CARRIAGE SHOULD JAM

Do not move the L CARRIAGE by force.
Remove it, then start knitting again.

1

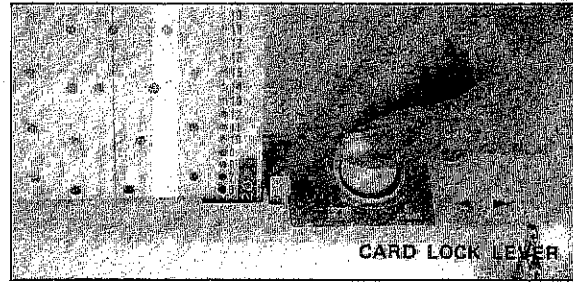

Set the CARD LOCK LEVER to the "●" mark.

2



Push the RELEASE BUTTON toward you to remove the L CARRIAGE.
If the L CARRIAGE is caught on the needles, take care in removing it.

3

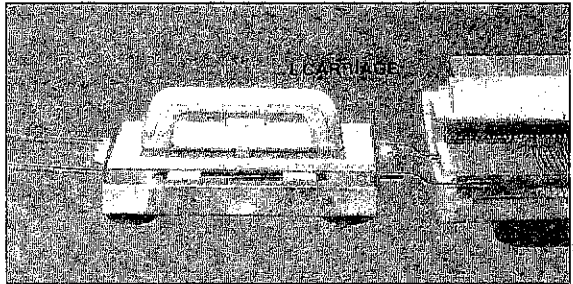

Place the L CARRIAGE firmly on the EXTENSION RAIL at the left side.

4

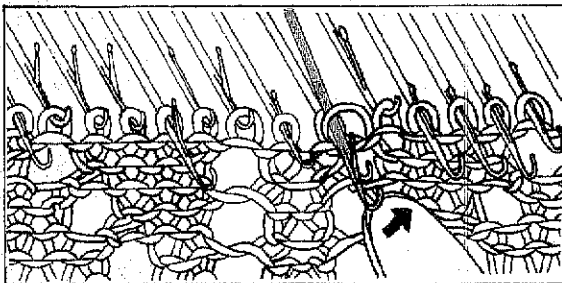

If needles get caught with each other, separate them by lifting tips as shown in the figure.

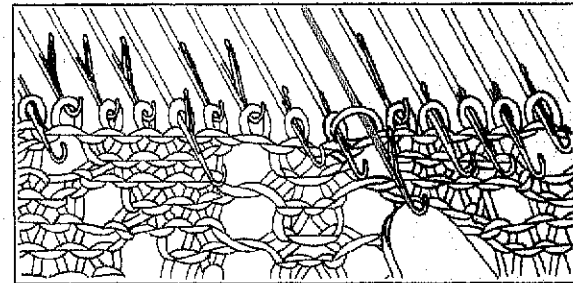

5

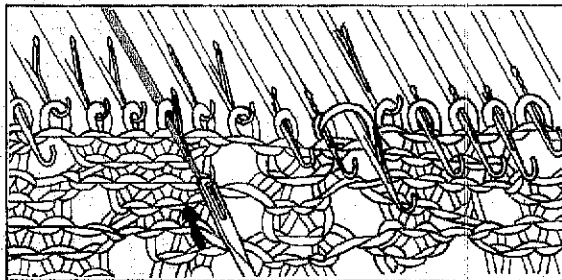

If the stitches are on the stem, transfer the stitches to the hooks of the needles by using the TRANSFER TOOL.

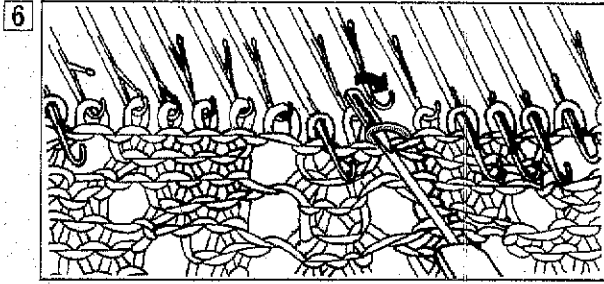

6 Return the transferred stitches to the adjacent needles by using the TRANSFER TOOL as shown in the figure.

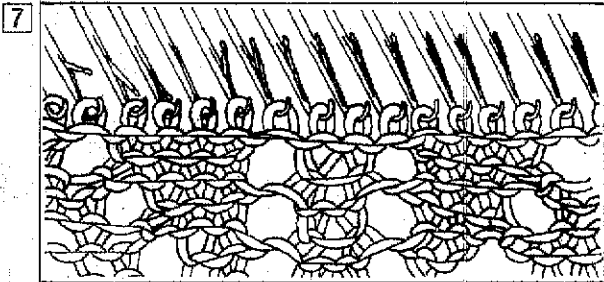
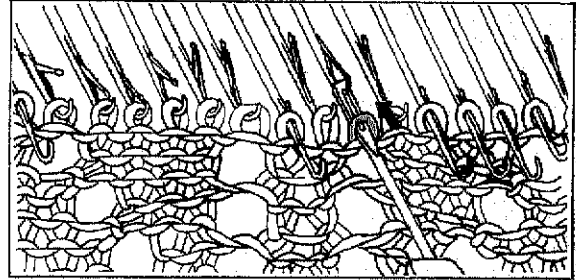

7 Return all the needles to position B.



8 Return the Punch card to the latest \ominus mark.

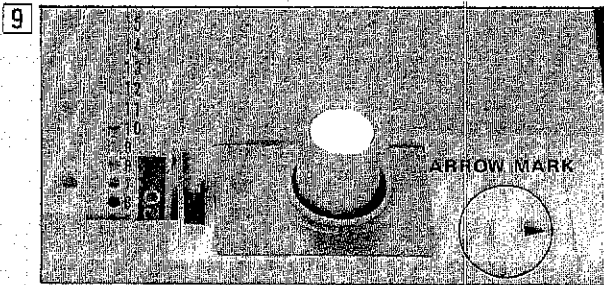

9 The ARROW MARK indicates the direction of the carriage.

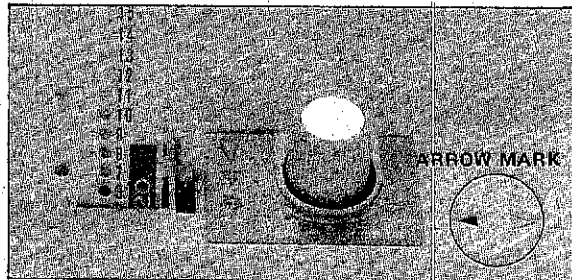

Check the ARROW MARK on panel. If the Arrow indicates the right \blacktriangleright direction, change to the left by passing the L CARRIAGE to the needle bed 2 rows (go and back). In this case, needles are not selected, Make sure that the Card lock lever is set at "●" position.

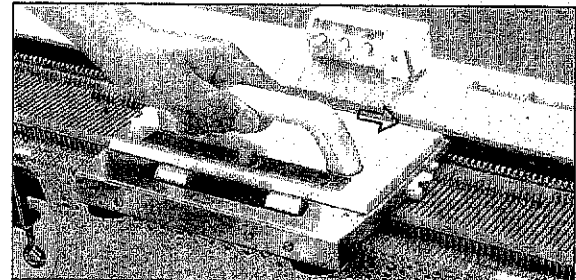

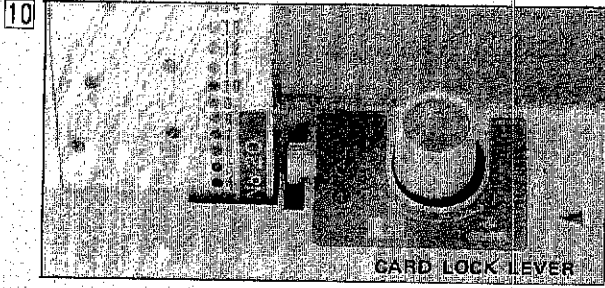

The arrow indicates the left ◀ direction.
Set the CARD LOCK LEVER to the "▼" mark.

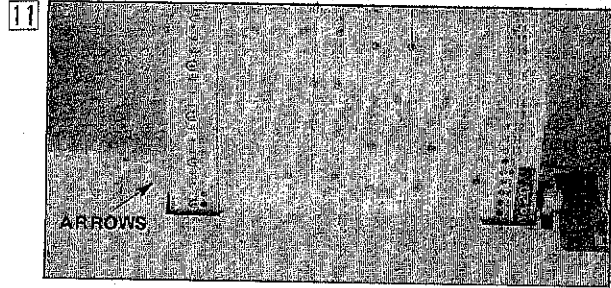

Operate the L CARRIAGE and the K CARRIAGE according to the arrows on the punch card.

8-2. UNRAVELLING THE KNITTING

If there are dropped stitches, unravel the knitting.
Then start knitting again.

Unravel the knitting after returning the stitches to hook
of the needles and return them to position B.

Unravel the knitting two rows and rewind the punch
card to the last Ⓒ mark.

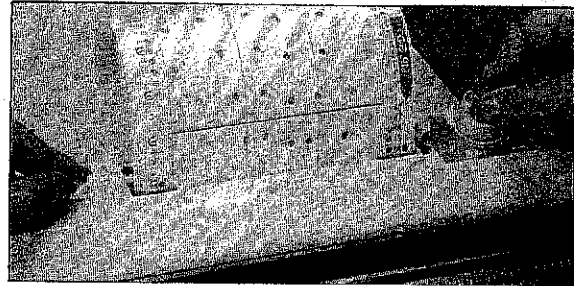

LESSON 3

9. MAKING A GARMENTS

9-1. HOW TO USE THE TRANSFER TOOL AND THE LATCH TOOL

9-1-1. Transfer tools

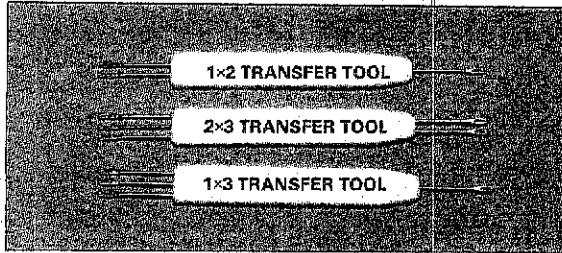

How to hold the transfer tool.

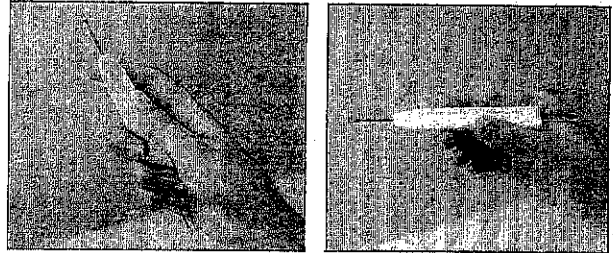

Decreasing stitches with Transfer Tool.

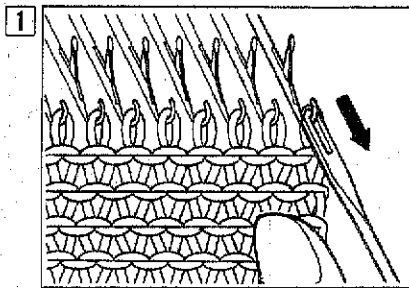

1 Hook the eye of the TRANSFER TOOL on the hook of the needle and pull it toward you.

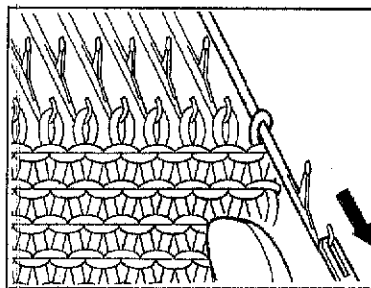

2 Hold your other hand against the knitting so that it will not be brought forward. The stitch in the hook of the needle will slide behind the latch and onto the stem of the needle.

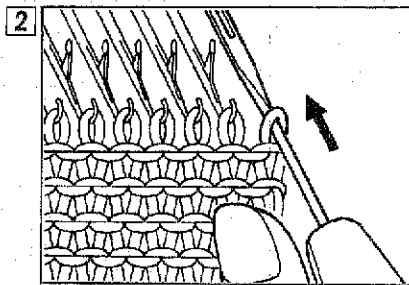

3 Hold the transfer tool parallel with the needle and push it all the way back until the stitch is transferred onto the TRANSFER TOOL.

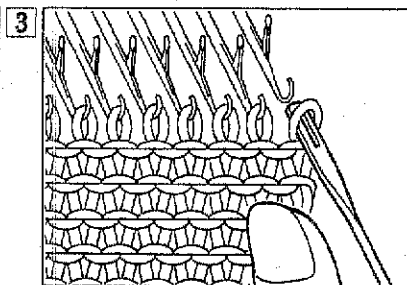

4 Remove the TRANSFER TOOL from the hook of the needle taking care not to drop the stitch from the TRANSFER TOOL.

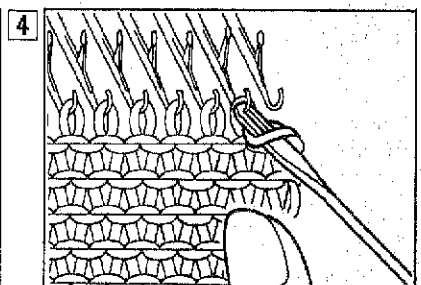

5 Hook the transfer tool onto the hook of the adjacent needle.

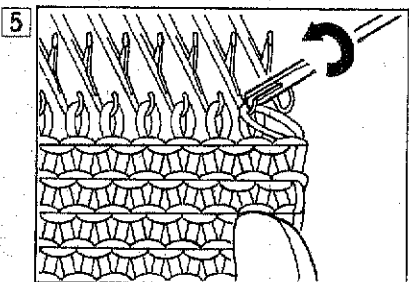

6 Transfer the stitch from the transfer tool onto the hook of the needle.

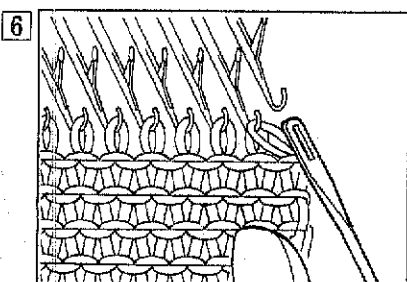

7 Remove the transfer tool from the hook of the needle and return the empty needle to position A.

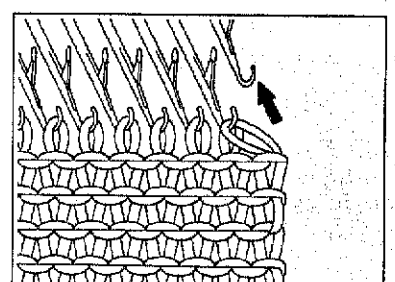

9-1-2. Latch Tool

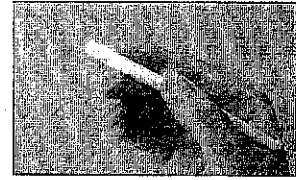
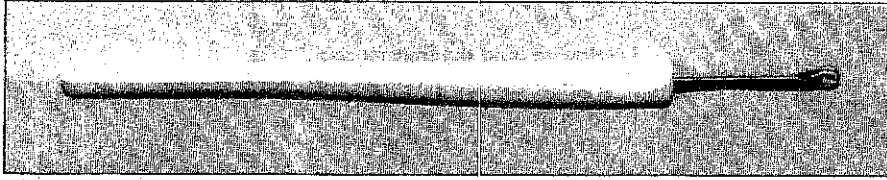

How to hold the latch tool.

Ribbing with the Latch Tool.

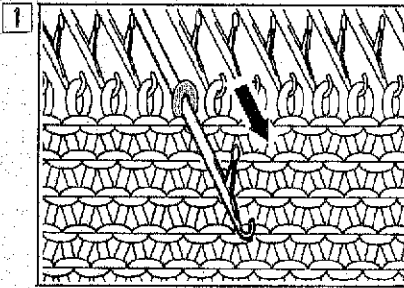

1 Bring one needle forward to position E by hand and return it to position A.

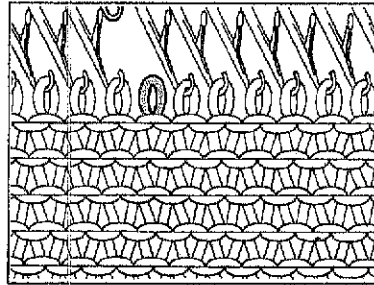

2 One stitch has been dropped from the hook of the needle.

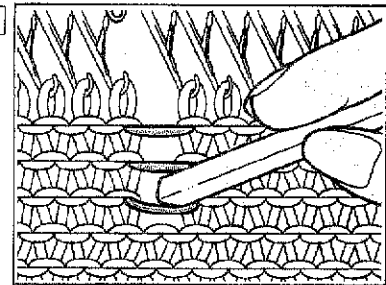

3 Using the tip of LATCH TOOL, unravel knitting.

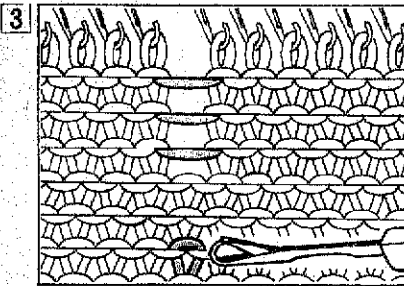

4 Drop the stitch in the line you wish to rib to a few rows above where you are to start ribbing. Then place the LATCH TOOL in the stitch where you wish to start ribbing.

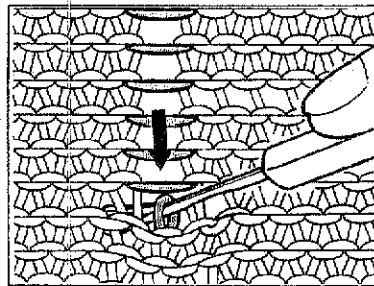

5 Depress the LATCH TOOL to drop the last few stitches. The stitch is on the stem of the latch tool.

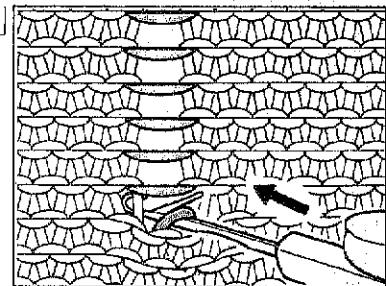

6 Hold the knitting firmly. Push the LATCH TOOL away from you until the stitch on the latch tool is behind the latch.

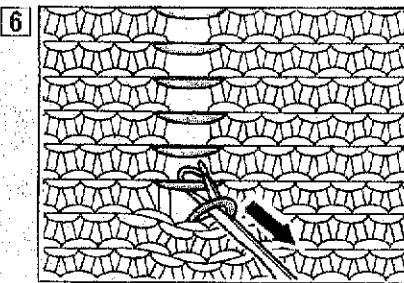

7 Catch the next parallel thread with the hook of the latch tool and pull the LATCH TOOL toward you.

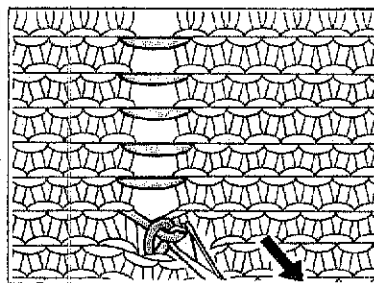

8 The latch will close with the new yarn in the hook. Pull this new yarn through the stitch on the stem of the latch tool to form a new stitch. Do not pull the latch tool strongly.

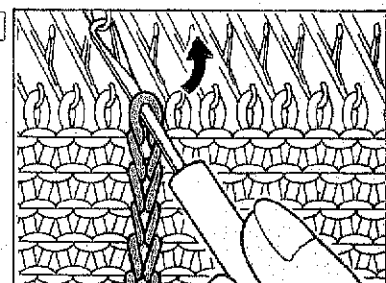

9 Repeat this until you reach the top, and hook the last stitch on the hook of the needle.

9-2. INCREASING AND DECREASING STITCHES PICKING UP DROPPED STITCHES

9-1-1. Increasing stitches

9-2-1-1. Increasing one stitch at either edge of the knitting. Simple method.

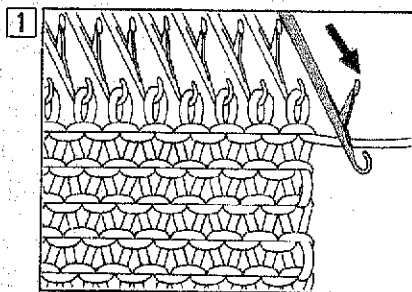

On the K carriage side, push one needle into working position B from position A.

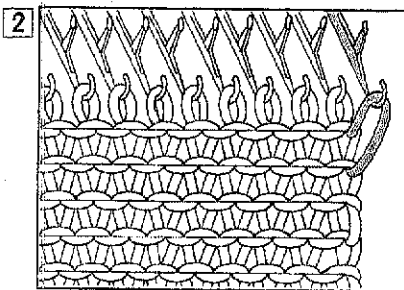

Operate the K carriage and knit one row. The empty needle will pick up the yarn.

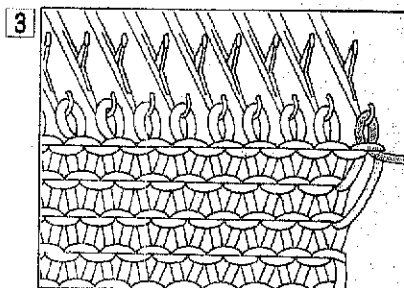

Using the tip of LATCH TOOL, unravel knitting.

9-2-1-2. Increasing one stitch at either edge of the knitting. Full fashioned method.

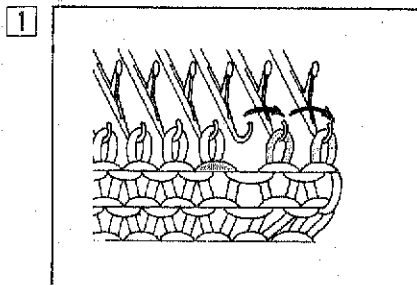

Using the 1 x 2 TRANSFER TOOL move the stitches out one needle so that the third needle from the end becomes empty.

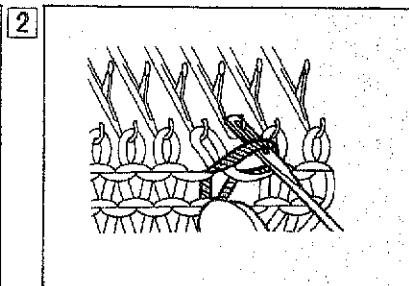

To fill in the empty needle pick up the purl side of either adjacent stitch on the lower row.

9-2-1-3. Increasing several stitches at either edge of the knitting.

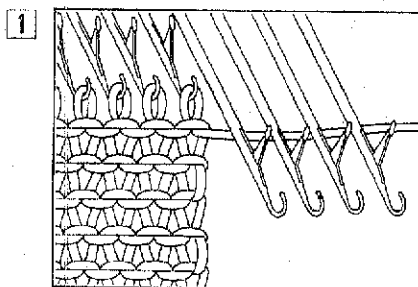

On the K carriage side, push the needles to be increased, to position E from A.

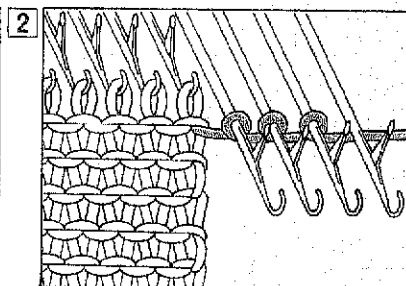

Wind the yarn loosely around the stems of each needle pushed to position E.

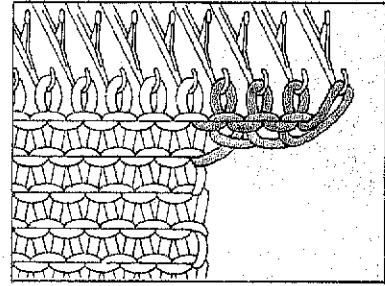
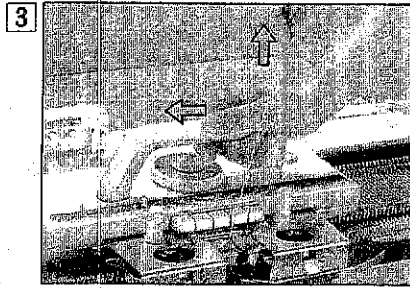

3 Pull up any slack between the K CARRIAGE and the end stitches and knit one row.

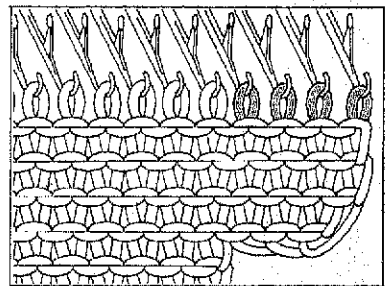
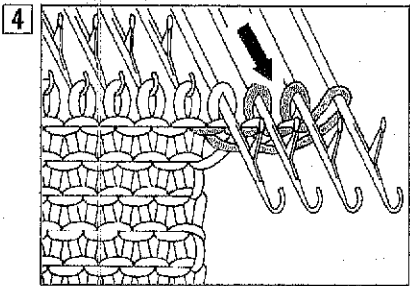

4 Push the needles with the increased stitches to position E and knit one row.

Repeat the two or three rows, and then continue to knit.

9-2-2. Decreasing stitches.

9-2-2-1. Decreasing one stitch at either edge of the knitting. Simple method.

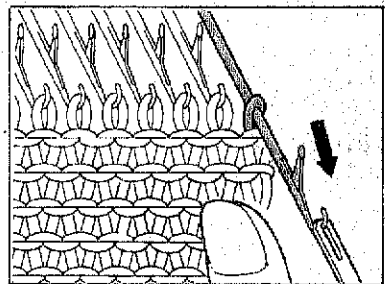
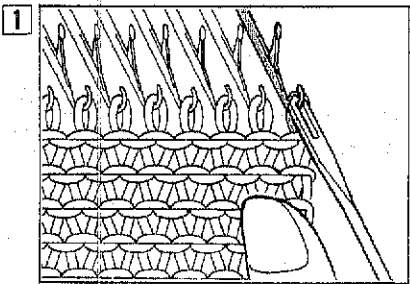

1 Hook the EYE of the TRANSFER TOOL on the hook of the needle, then pull it toward you.
Hold your other hand against the knitting so that it is not brought forward.

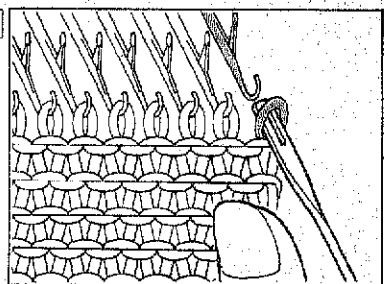
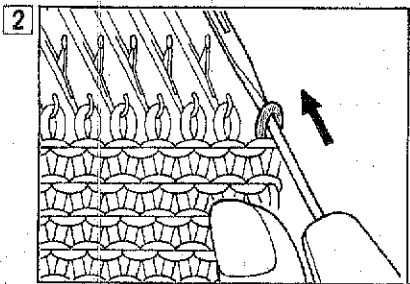

2 Hold the TRANSFER TOOL parallel with the needles and push it all the way back. Then the stitch will be transferred to the TRANSFER TOOL.

3 Remove the TRANSFER TOOL from the hook of the needle taking care not to drop the stitch from the TRANSFER TOOL.

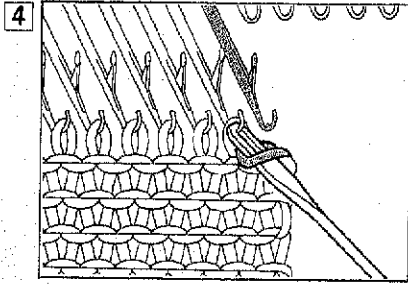

4 Hook the transfer tool on the hook of the adjacent needle.

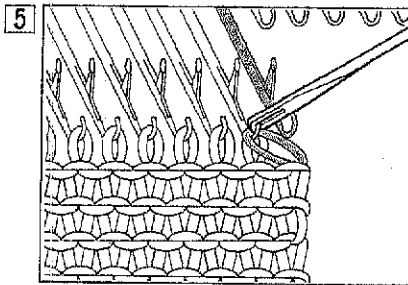

5 Transfer the stitch from the TRANSFER TOOL to the hook of the needle.

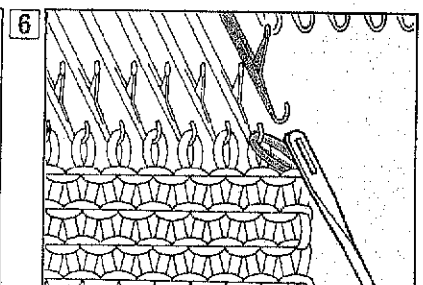

6 Remove the TRANSFER TOOL from the hook of the needle.

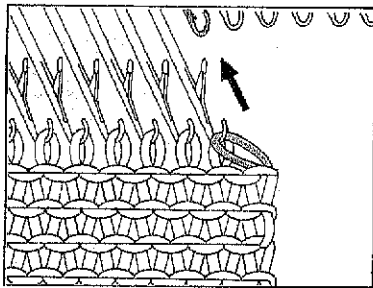

Return the empty needle to position A. Then you have decreased one stitch.

9-2-2. Decreasing one stitch at either edge of the knitting. Full fashioned method.

Use the 1 x 2 TRANSFER TOOL to transfer two stitches at the end to the inside needles, and place empty needle out of action to position A.

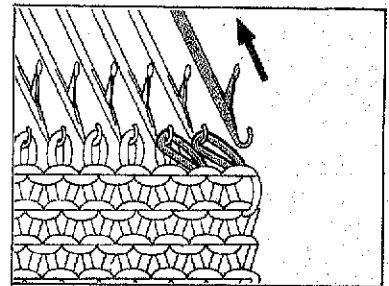

9-2-2-3. Decreasing several stitches at either side of the knitting.

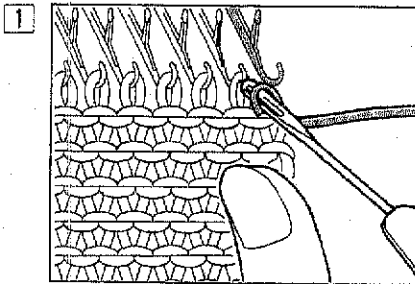

1 On the same side as the K CARRIAGE, transfer the end stitch to the 2nd needle.

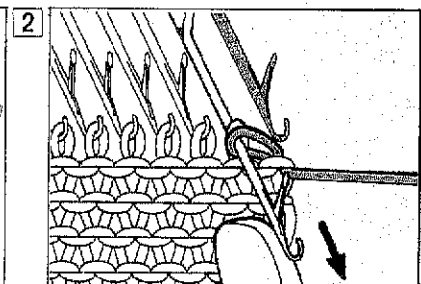

2 Bring forward the needle with the two stitches so that the stitches fall behind the needle latch.

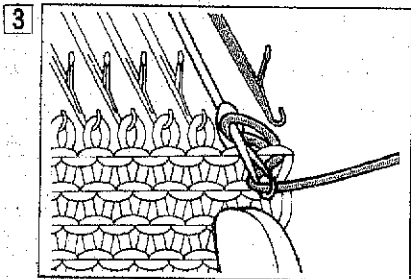

3 Place the yarn in the needle hook, in front of the latch and push the needle back manually to form a single stitch.

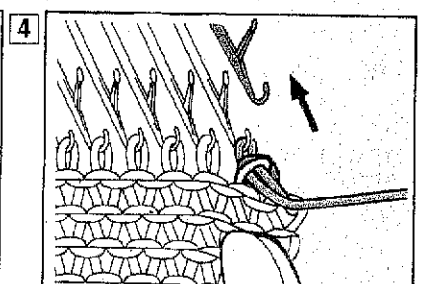
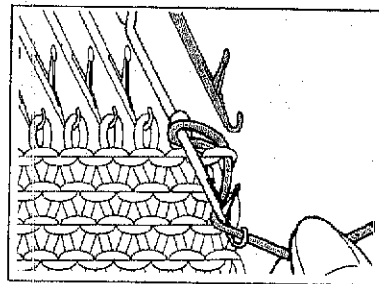

4 Return the empty needle to position A.

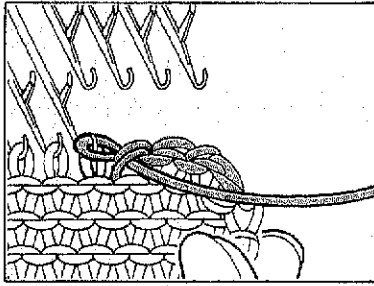

Repeat this process for each stitch. Take care not to make the stitches too tight.

When you reach the last stitch, hang the last stitch on the adjacent needle. (Two stitches are on the hook of the needle.)

Then operate the K CARRIAGE.

9-2-3. Picking up dropped stitches

9-2-3-1. Repairing a dropped stitch

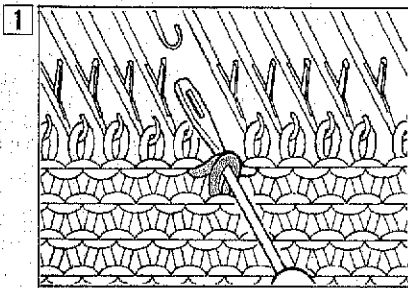

Using a TRANSFER TOOL, pick up the stitch (the row below the dropped stitch) and the unknitted yarn and put both of them on the empty needle.

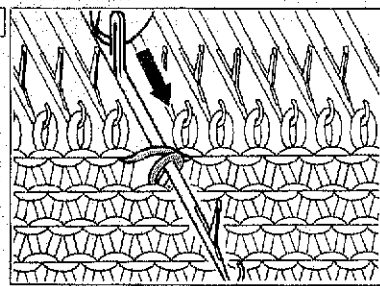
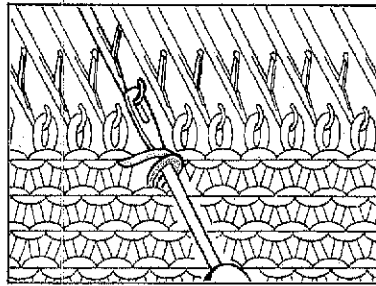

Push the needle to position E. Stitch and unknitted yarn are now behind the latch.

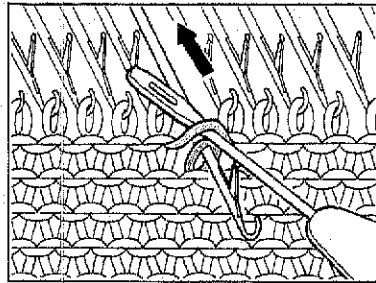

Push the needle back until stitch is just behind the latch. Using a TRANSFER TOOL, catch the unknitted yarn into the hook of the needle.

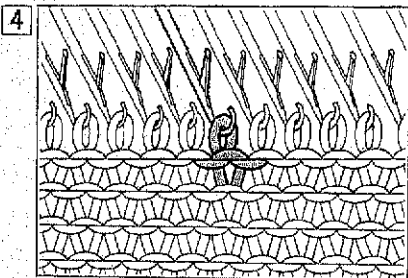

Then return the needle to position B pulling the yarn in the hook through the stitch on the stem of the needle. The stitch has now been reknitted.

9-2-3-2. Repairing a stitch that has dropped several rows.

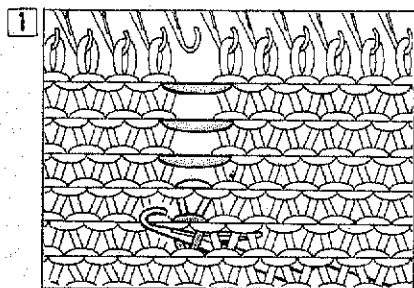

Insert the latch tool from behind knitting through the last stitch that has not dropped.

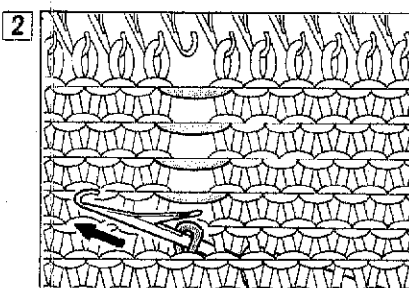

Push the latch tool towards you pulling slightly down on knitting so that the stitch comes behind the latch.

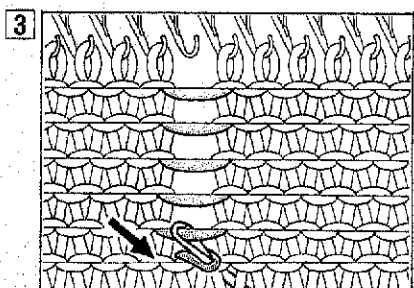

Catch the next cross thread into the hook and pull back the LATCH TOOL through the stem. There is now one stitch.

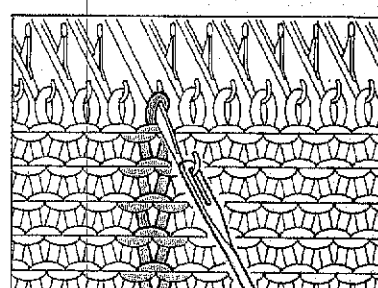
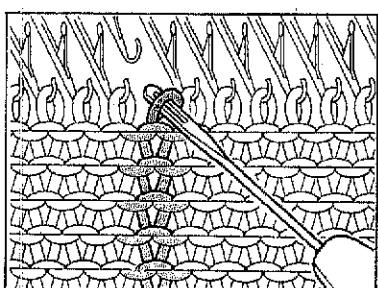
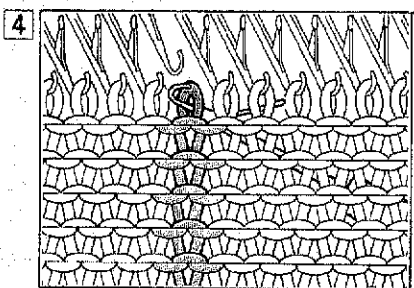
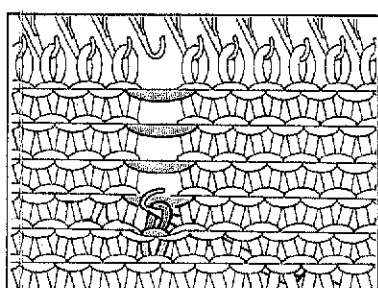

Repeat this until you reach the top. Pull the last stitch rather tight to make a bigger loop. Insert the transfer tool into the loop from the front. Carefully remove this stitch from the latch tool and place it on the hook of the needle with your transfer tool.

9-3. HOW TO MAKE A HEM

9-3-1. Plain hem

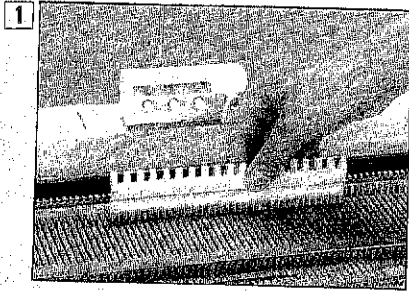

Using the 1/1 NEEDLE PUSHER bring forward to position B the required number of needles, after selecting an equal number of needles on either side of the center "0".

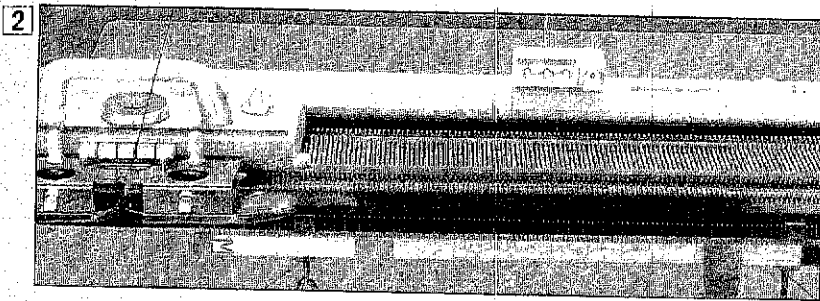

Knit about ten rows of plain knitting with waste yarn and put the K CARRIAGE on the left side of the machine.

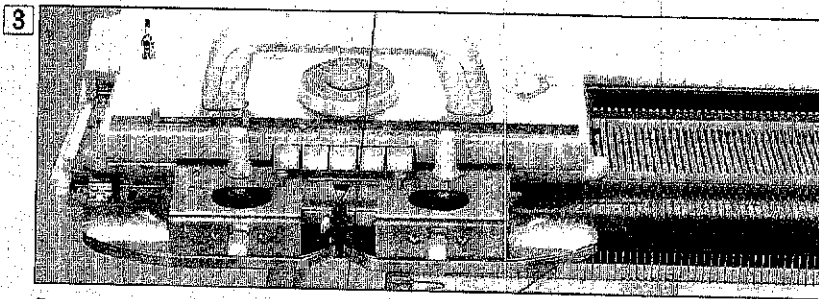

Pull the waste yarn out of the YARN FEEDER "A". Remove the CAST-ON THREAD from the accessory box.

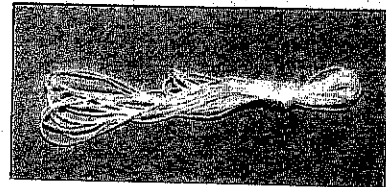

CAST-ON THREAD

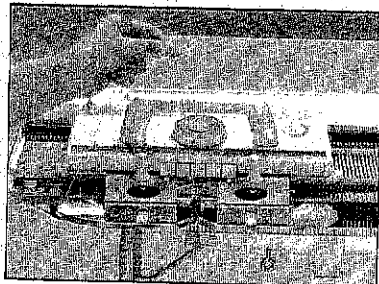

Thread the CAST-ON THREAD into YARN FEEDER "A".

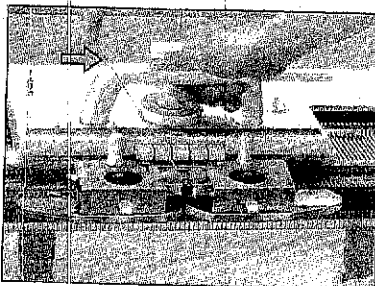

Move the K CARRIAGE to the right holding the CAST-ON THREAD with your left hand.

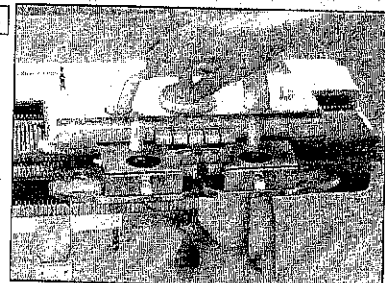

Pull the CAST-ON THREAD out of the YARN FEEDER "A" and thread the regular knitting yarn into YARN FEEDER "A". Set the ROW COUNTER at "0".

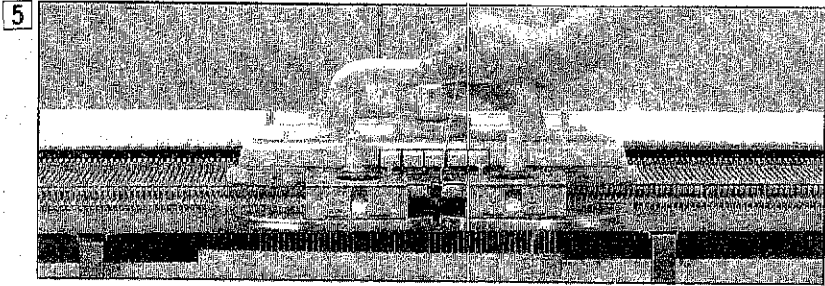

Knit in plain knitting with the yarn. For the first row, move the K CARRIAGE holding the yarn under the YARN FEEDER "A" with your left hand at the right edge of the knitting. Knit the number of rows required, for double the length of the hem. Remove the CAST-ON COMB from the knitting.

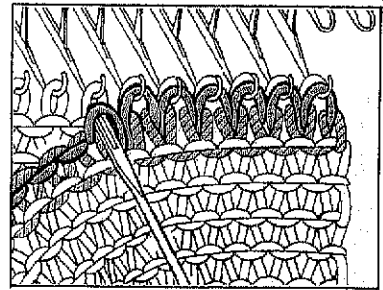
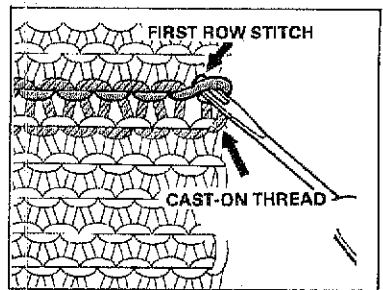
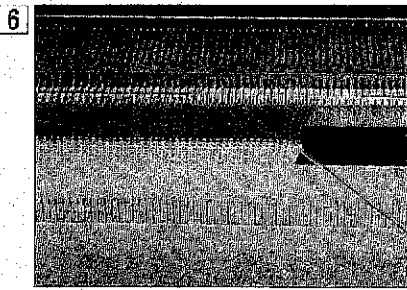

Pick up the first stitch of the first row where it meets the CAST-ON THREAD. Repeat across the row.

Insert the TRANSFER TOOL. Hook

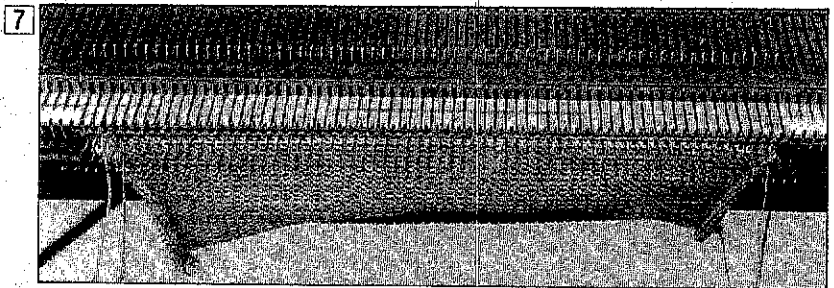

After picking up all the stitches, bring all the needles forward to position E. (There will be one less stitch to be picked up than there are needles.)

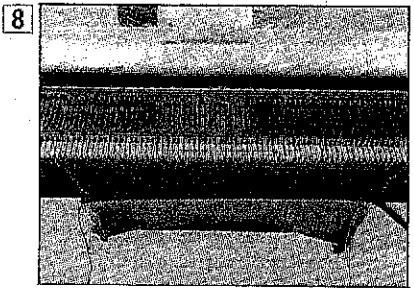

Operate the K carriage and continue to knit in plain knitting.

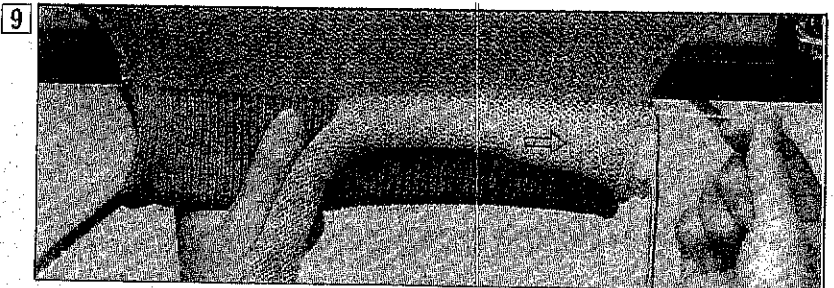

After knitting several rows, pull out the CAST-ON THREAD. Then the part knitted with the waste yarn is removed and the PLAIN HEM is made.

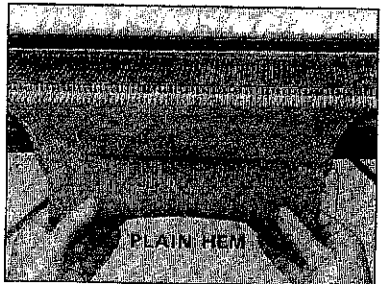

9-3-2. Picot hem

- 1 After knitting with waste yarn and CAST-ON THREAD, knit up to half the depth of the hem. (The K CARRIAGE is on the right side of the machine.)

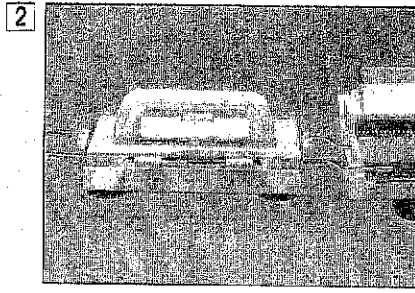

Place the L CARRIAGE on the left side EXTENSION RAIL.

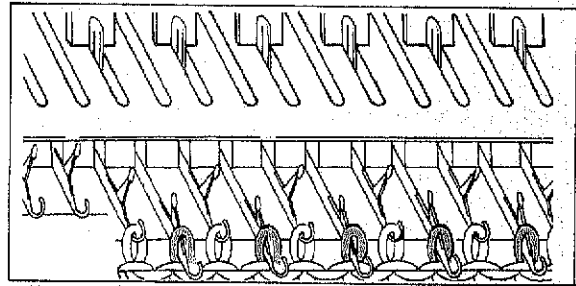
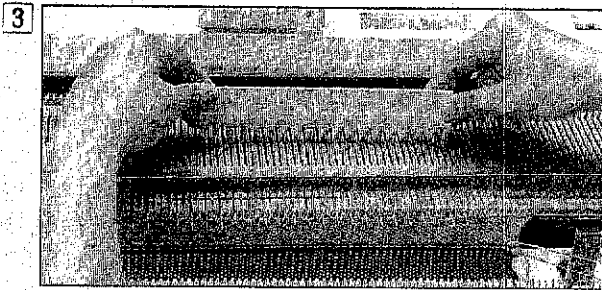

Starting with the second needle from either end, bring forward every alternate needle to position D by using the 1/1 NEEDLE PUSHER. End needles must remain in position B.

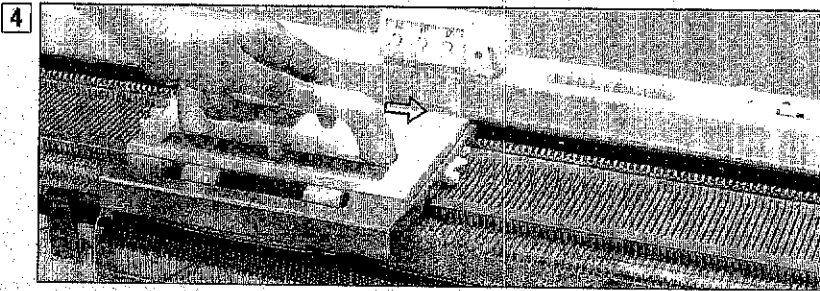

Move the L CARRIAGE to right.

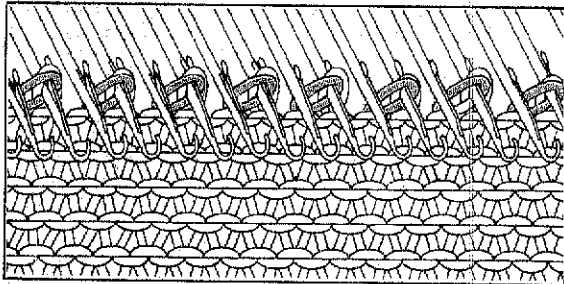

Every second stitch has now been transferred to the adjacent needle.

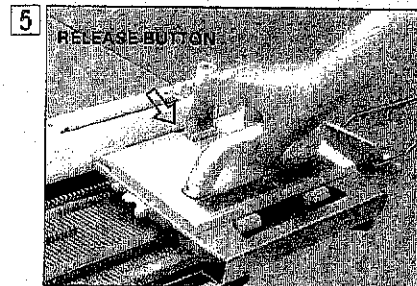

Remove the L CARRIAGE from the machine by pushing the RELEASE BUTTON.

6

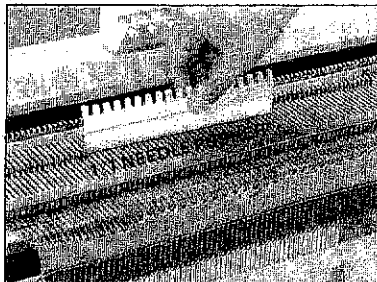

Return the needles to position B.

7

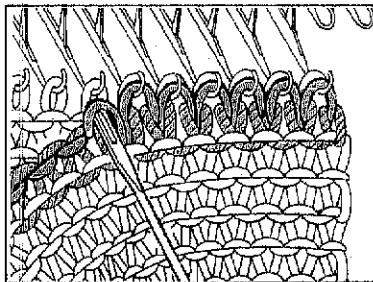

Knit the other half of the hem and pick up the stitches in the same way as for the plain hem. After picking all the stitches up, bring the needles to position E.

8

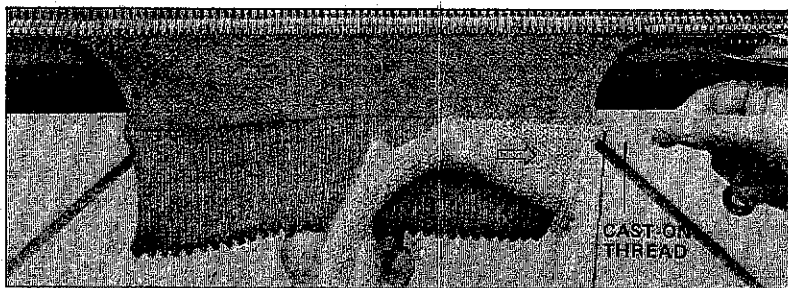

After knitting several rows, pull out the CAST-ON THREAD. The part knitted with waste yarn is removed. Then you have made a PICOT HEM.

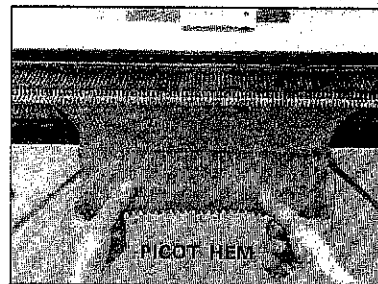

9-3-3. 1 x 1 Elastic hem

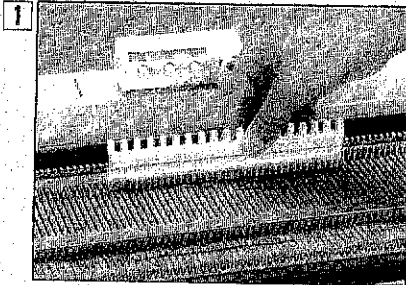

1 Bring forward the required needles to position B by using the 1/1 NEEDLE PUSHER.

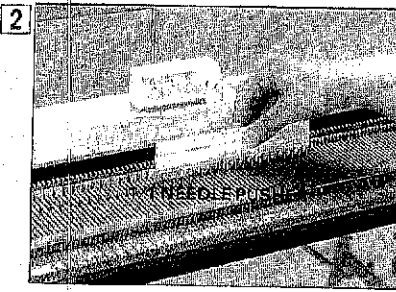

2 Return every other needle to position A by using 1/1 NEEDLE PUSHER.

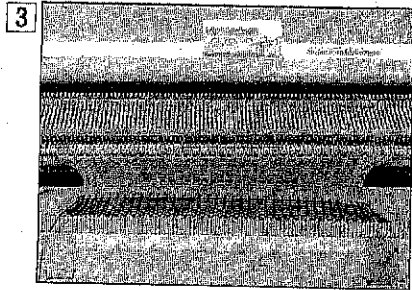

3 Knit with the waste yarn in the same way as for plain hem. Then knit one row with CAST-ON THREAD and change the yarn.

4 Knit the number of rows required for double the length of the hem in plain knitting with the yarn.

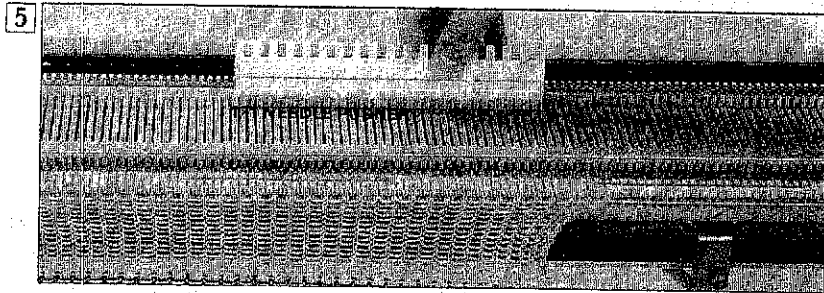

5 Bring forward the needles in position A to position B.

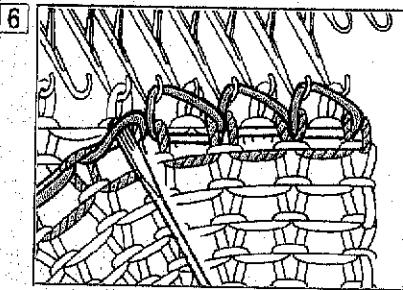

6 Pick up the stitches in the same way as for the plain hem and hook them onto the empty needles.

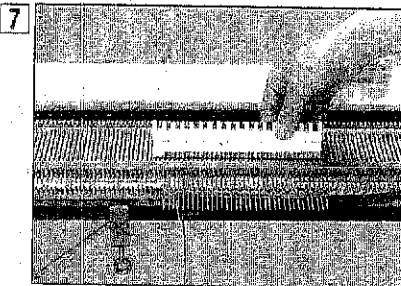

7 After picking up all the stitches, bring the needles to position E. Knit one row.

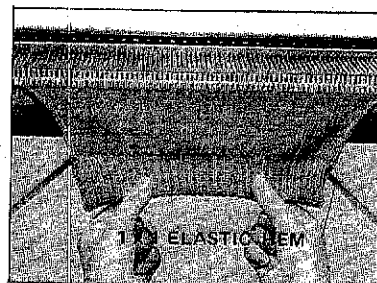
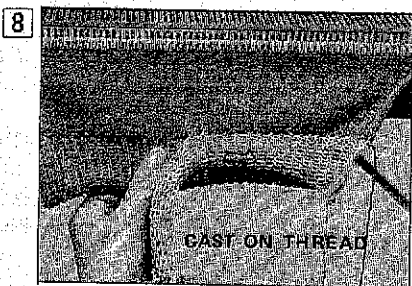

8 After knitting several rows, pull out the CAST-ON THREAD. The part knitted with the waste yarn is removed. Now 1 x 1 ELASTIC HEM is completed.

9-4. BINDING OFF AND BUTTON HOLE

9-4-1. Binding off using the tapestry needle

After finishing the knitting, bind off last row taking care not to unravel the knitting.

9-4-1-1. When the yarn is on the left side

- 1 Pull the yarn out of the YARN FEEDER. Cut the yarn leaving a length of three times the width of the knitting.

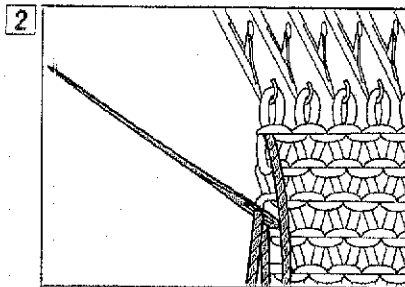

2 Thread the yarn into the TAPESTRY NEEDLE.

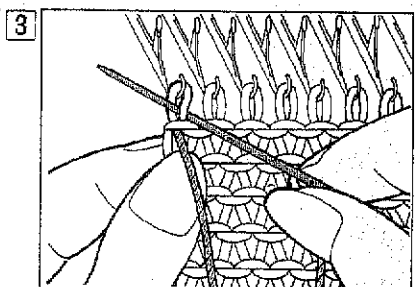

3 Pass the TAPESTRY NEEDLE through the left side stitch.

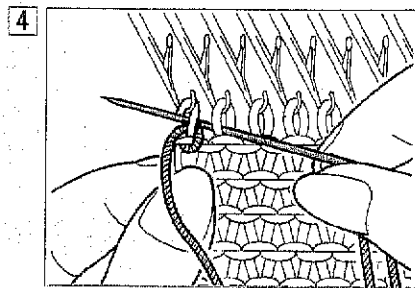

4 Insert the tapestry needle into the second stitch from left and pass it back through the left side stitch.

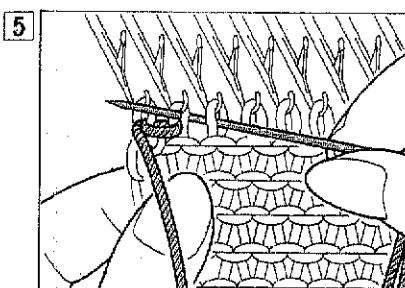

5 Insert the tapestry needle into the third stitch from left and pass it back through the second stitch from left.

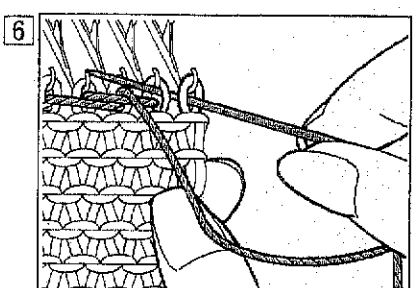

6 Repeat this until you reach to the right side of the knitting.

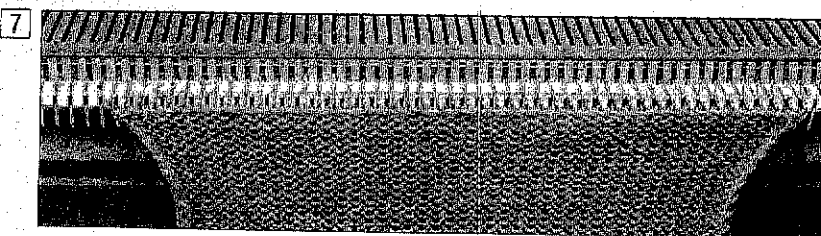

7 Now, the binding off is completed and piece can be removed from the machine.

9-4-1-2. When the yarn is on the right side

1 Pull the yarn out of the YARN FEEDER. Cut the yarn leaving a length of three times the width of the knitting.

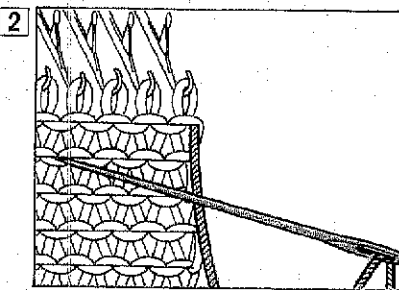

2 Thread the yarn into the TAPESTRY NEEDLE.

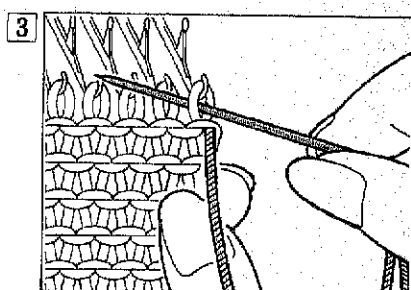

3 Pass the TAPESTRY NEEDLE through the right side stitch.

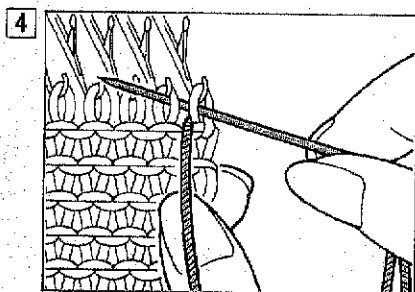

4 Insert the TAPESTRY NEEDLE into the right stitch and pass it through the second stitch from right.

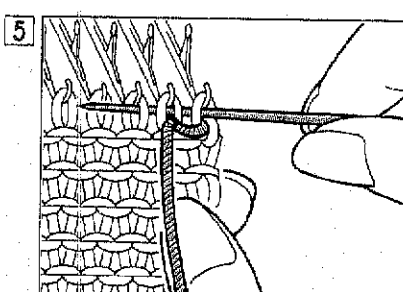

5 Insert the TAPESTRY NEEDLE into right side stitch and pass it through the third from right in the figure, making sure you pass the tapestry needle BEHIND the second stitch and enter the third stitch from behind.

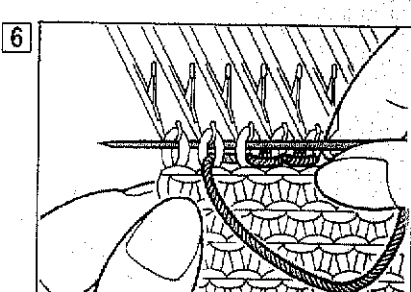

6 Repeat this until you reach the left side of the knitting.

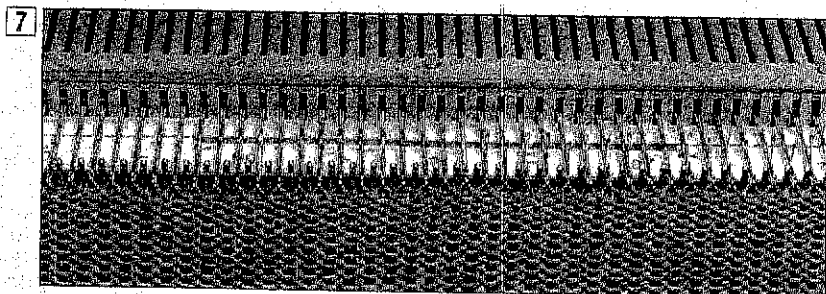

7 Now, the binding off is completed.

9-4-2. Cast-off using the latch tool

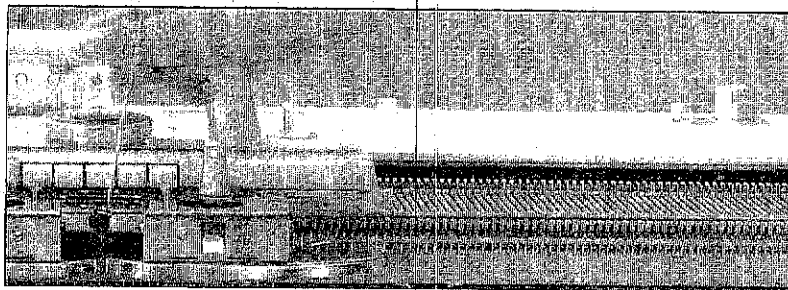

- 1 Loosen the TENSION DIAL and knit the last row. (For example, when knitting with tension dial number 4-6, set the number to 9-10.)
- 2 Place the K carriage on the left side of the machine.

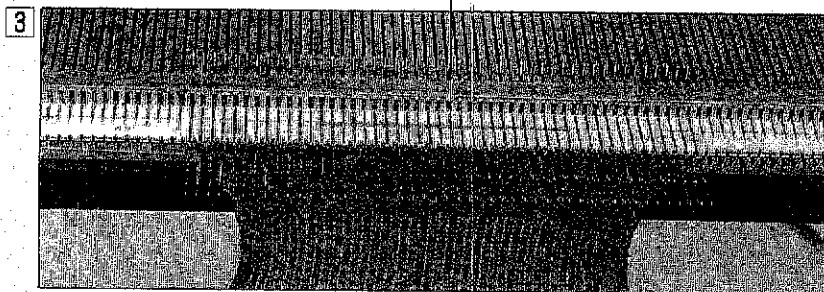

Bring the needles forward to position E.

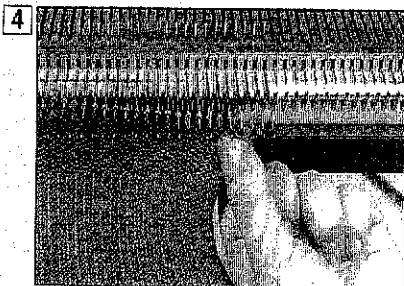

Bring the knitting toward you taking care not to drop the stitches.

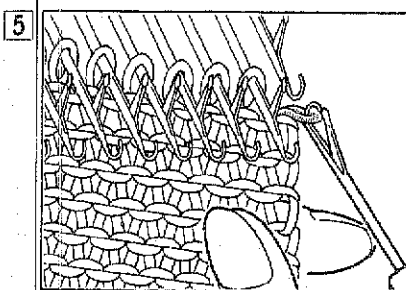

Hook the right side stitch on the hook of the LATCH TOOL.

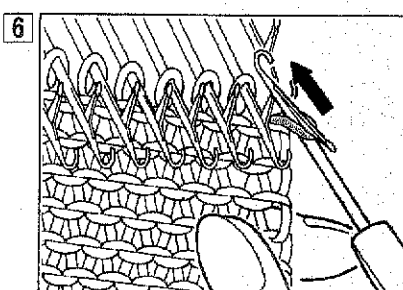

Make the stitch fall behind the latch of LATCH TOOL.

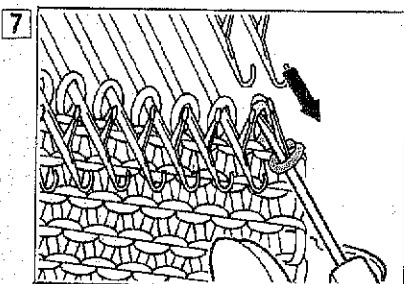

Then hook the second stitch from the right in the hook of the LATCH TOOL.

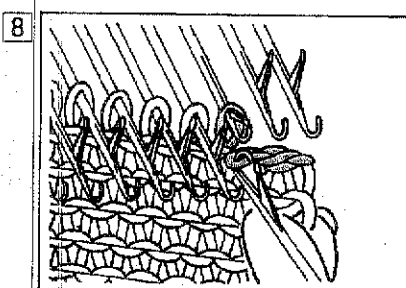

Pull the LATCH TOOL and make a new stitch (with the stitch over the latch and the stitch on the hook).

Take care not to drop the other stitches from the needles.

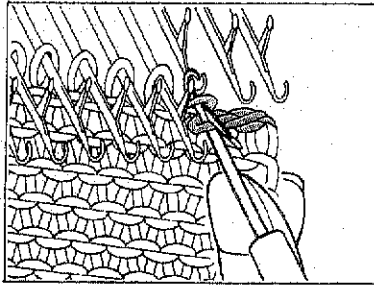

Repeat this until you reach the left side making new stitches across the row.

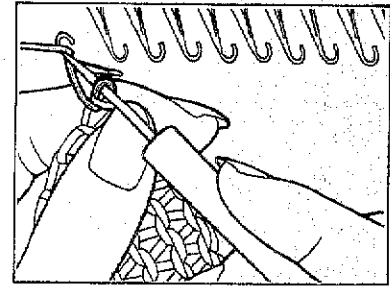

Make the new stitch fall behind the latch of LATCH TOOL, and hook the third stitch on the hook of the latch tool.

When you reach the last stitch, hook the end of the yarn on the hook of the LATCH TOOL and pull the end of the yarn through the stitch on the stem.

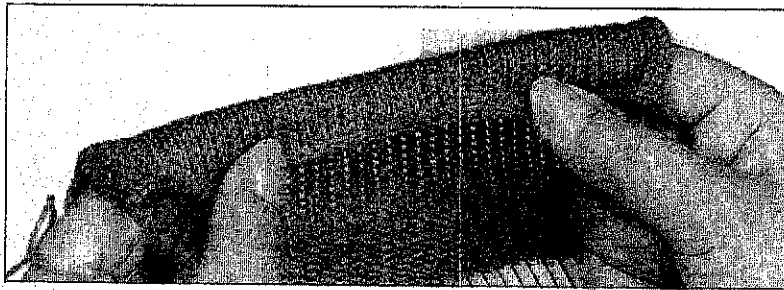

Now, the binding off is completed.

9-4-3. Vertical Seaming of plain stitch

1. Left hand piece — Pass the tapestry needle under threads of 1st and 2nd rows, bringing tapestry needle through to upper side.
2. Right hand piece — Pass the tapestry needle under threads of 2nd and 3rd rows, bringing tapestry needle through to upper side.
3. Left hand side — Pass the tapestry needle under threads of 3rd and 4th rows, bringing tapestry needle through to upper side.
4. Right hand side — Pass the tapestry needle under threads of 4th and 5th through to upper side.
5. Continue to seam in this way.

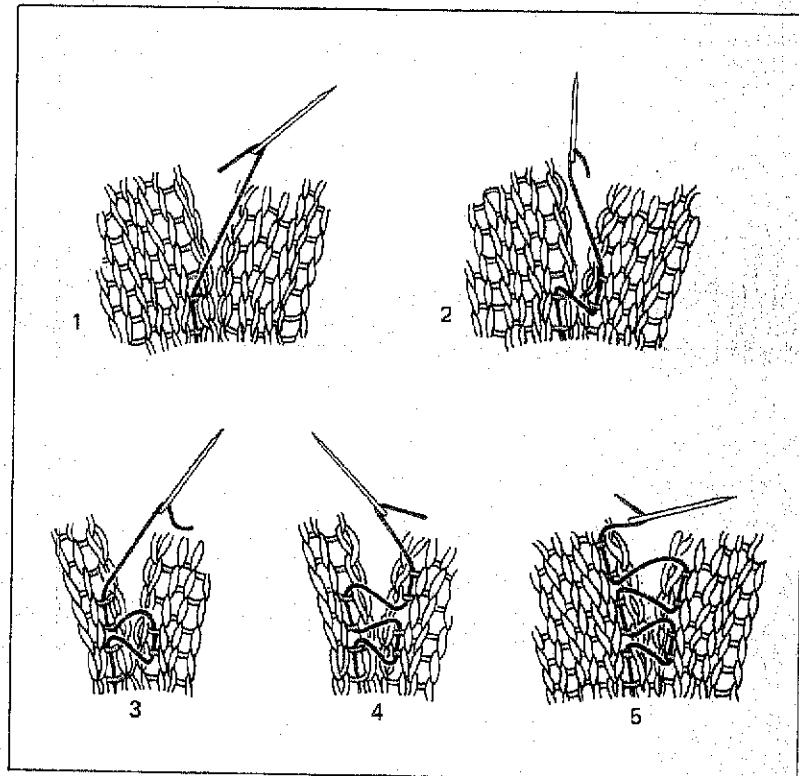

**9-4-4. How to make
a button hole**

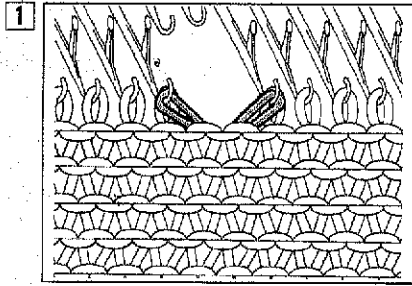

Using the 1 x 2 TRANSFER TOOL move the stitches, where you are going to make a button hole, to adjacent needles as shown in the figure.

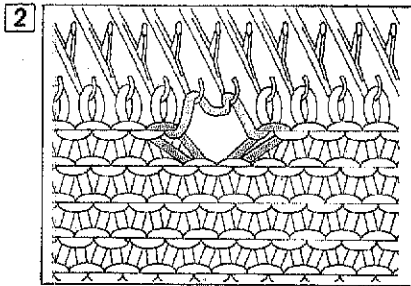

Bring back the empty needles to position B, and knit one row. The yarn will hook on the two needles.

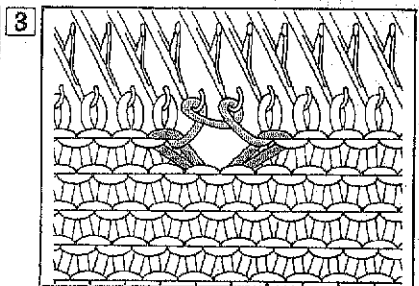

Loop the yarn around the two needles by hand as shown in the figure.

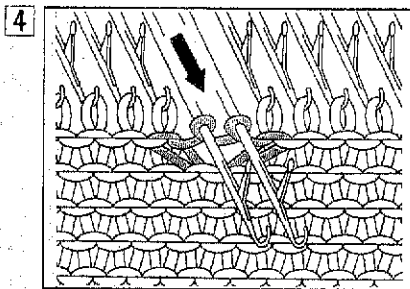

Bring the two looped needles forward to position E and operate the K CARRIAGE.

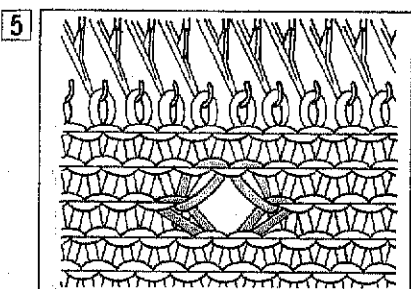

Then you have made a button hole.

9-5. HOW TO SHAPE A ROUND NECK LINE

9-5-1. Using the holding cam lever

9-5-1-1. Plain knitting.

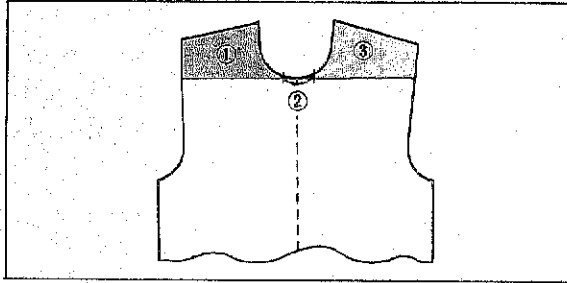

Knit the left and right side of the round neck line separately.

★ The example is showing that the yarn end is on the left side. When starting to knit the Neck line, if yarn end is on the right side, knit part ③ first by regarding the RIGHT as LEFT in following instructions.

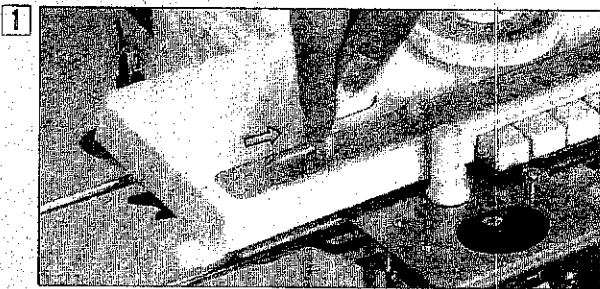

1 Set the HOLDING CAM LEVER of the K CARRIAGE to position H.

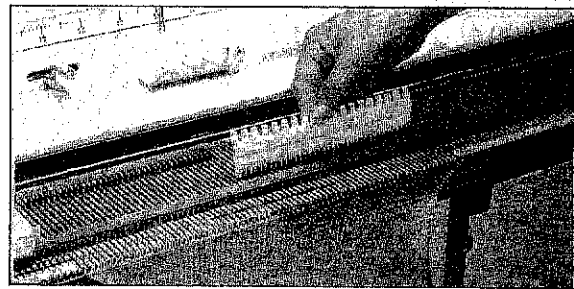

Bring forward to position E all the needles on the opposite side of the K CARRIAGE including the stitches for the center neck line and opposite shoulder. These needles will not knit.

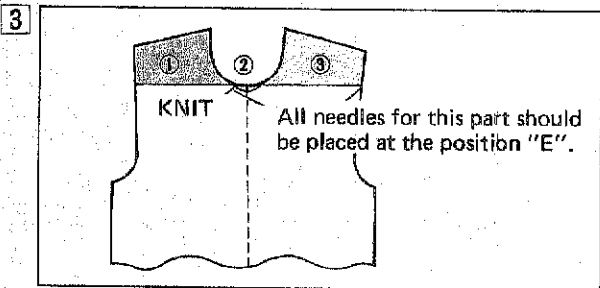

3 Knit part ① according to your pattern. Decreasing at the neck edge will be done by using the Transfer Tool. Decrease in this manner until you have the required number of stitches left for the shoulder. Bind off the shoulder stitches.

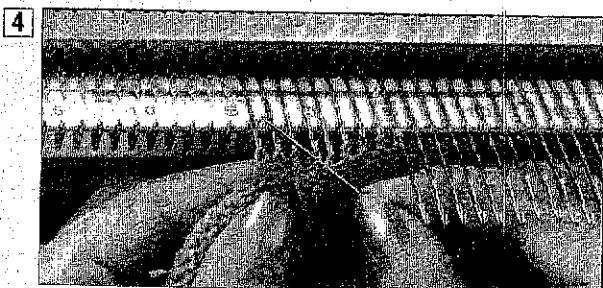
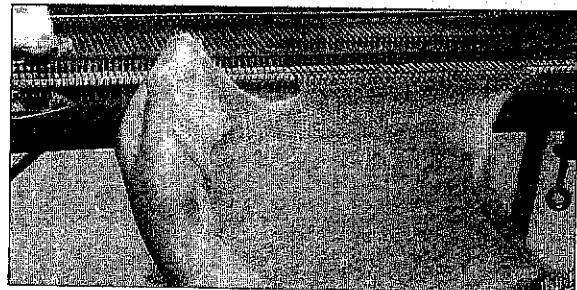

4 Return the center neck line stitches ② to position B by transferring the stitches onto the hooks of the needles and bind off.

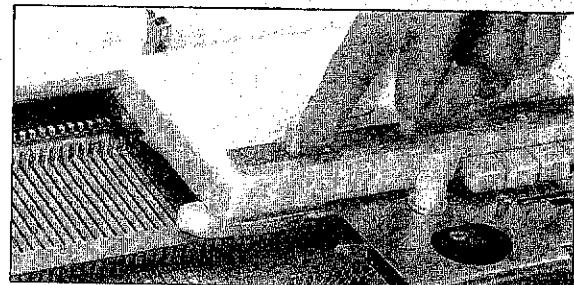

Set the HOLDING CAM LEVER of the K CARRIAGE to position N.

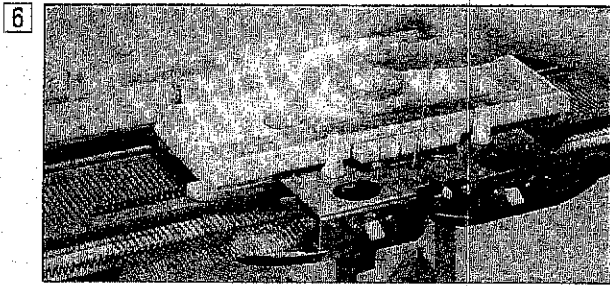

6 Thread the yarn into YARN FEEDER A and knit the other side of the neck and shoulder for part ③

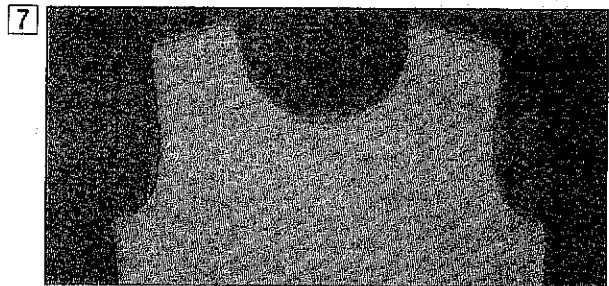

7 The neck line is completed.

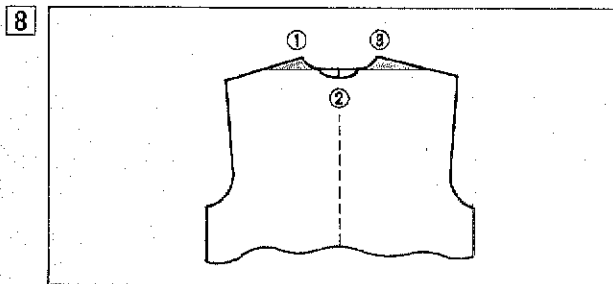

8 Knit the back in the same way. (Knit the left and right sides separately.)

9-5-1-2. Pattern knitting.

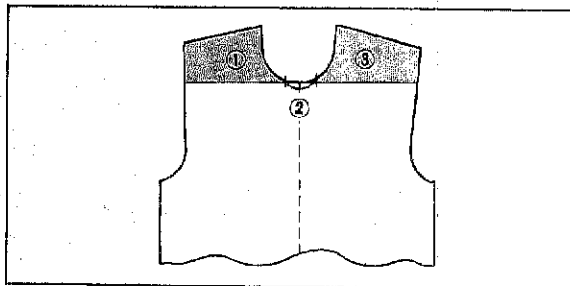

Knit the left and right side of a round neck line separately.

★ The example is showing that the yarn end is on the left side. When starting to knit the Neck line, if yarn end is on the right side, knit part ③ first by regarding the RIGHT as LEFT in following instructions.

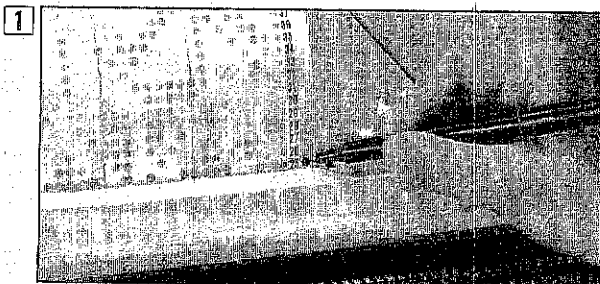

1 Knit one side in the same way as the plain knitting. Before you start knitting the first side, mark on the PUNCH CARD so that you can return to the exact row when you knit the other side.

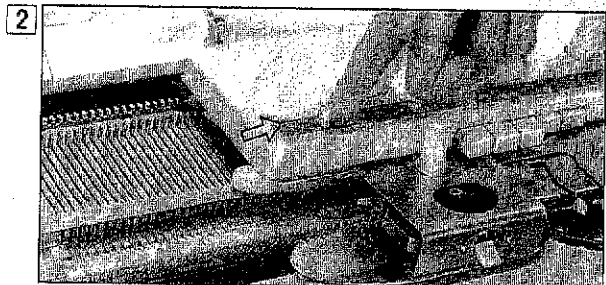

2 Set the HOLDING CAM LEVER of the K CARRIAGE to position H.

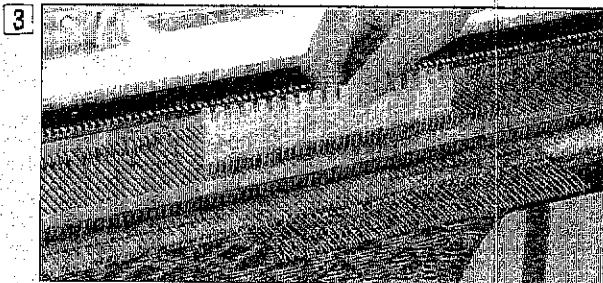

Bring forward to position E all the needles on the opposite side of the K CARRIAGE including the stitches for the center neck line and opposite shoulder. These needles will not knit.

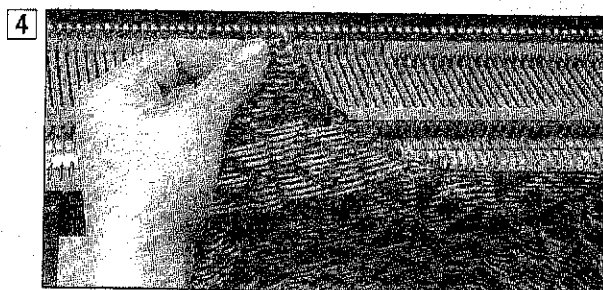

Knit side ① according to your pattern.

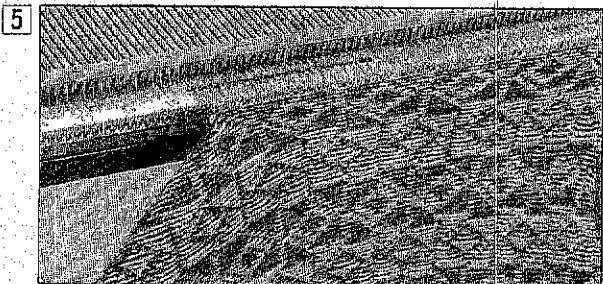

After knitting the first side ①. Using a TRANSFER TOOL, place the stitches for part ② and ③ onto the hooks of the needles and return to position B.

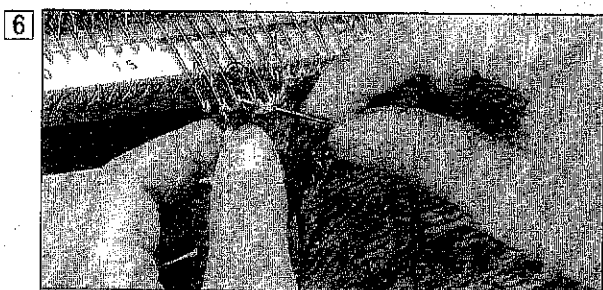

Leaving the needles for part ③ in position B, bind off the center neck line stitches for part ②.

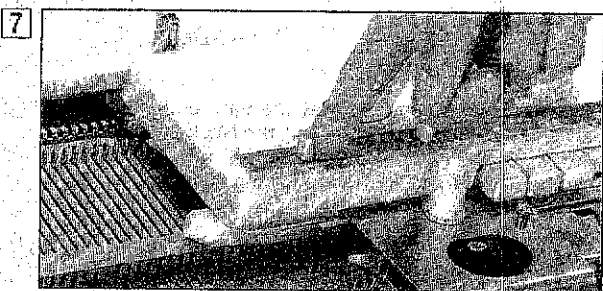

Set the Holding Cam Lever of the K CARRIAGE to position N.

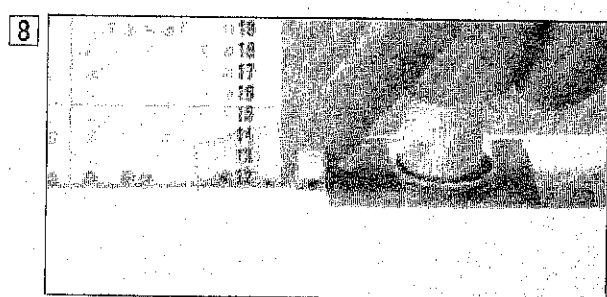

Return the PUNCH CARD to the mark on it and set the CARD LOCK LEVER to the "●" mark.

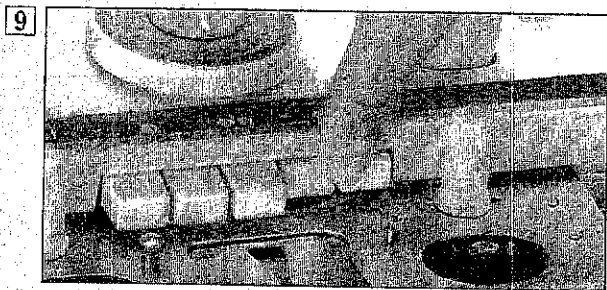

Push the CAM BUTTONS "PART".

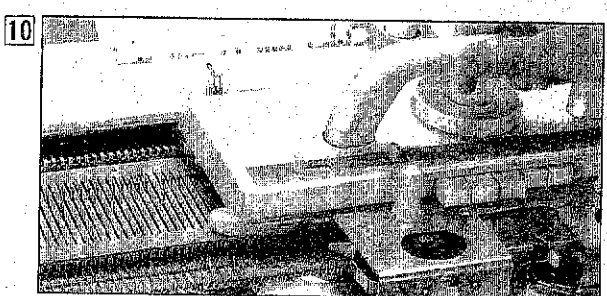

Set the CHANGE KNOB to KC, and operate the K CARRIAGE without threading the yarn into the YARN FEEDER. The needles are selected for the pattern.

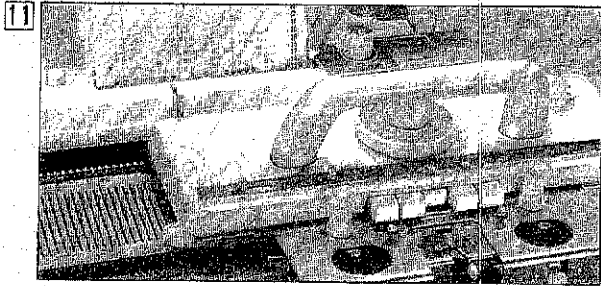

Set the CAM BUTTON according to the pattern knitting and set the CARD LOCK LEVER to the "▼" mark.

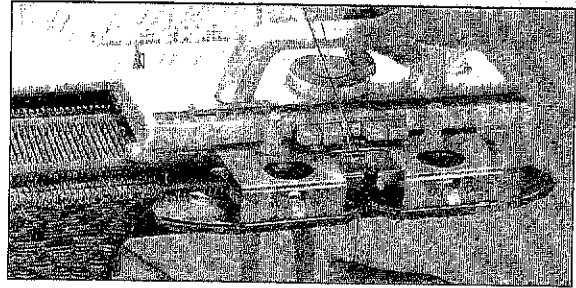

Thread the yarn into the YARN FEEDER "A" and knit the other side ③. For Fair-isle patterns or Weaving patterns, do not forget to thread the second color yarn into the YARN FEEDER.

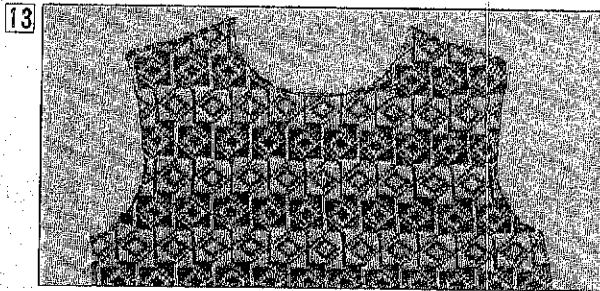

The neck line is completed.

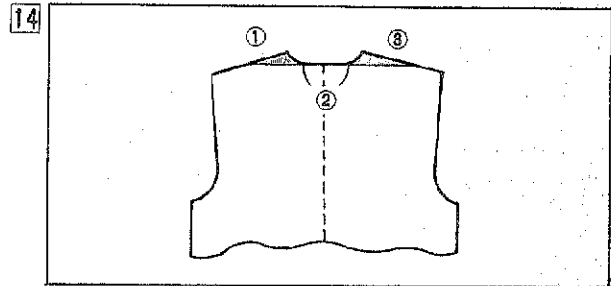

Knit the back in the same way.

9-5-2. Using the cast-on thread

Lace Pattern Knitting

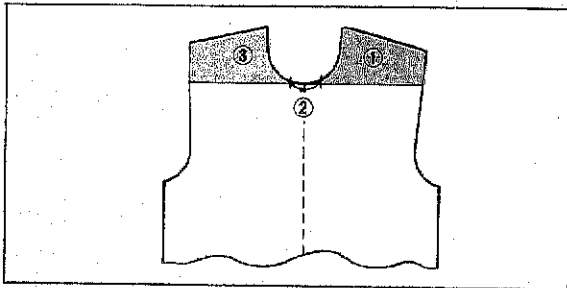

For shaping a round neck line, knit left and right side separately.

- ★ For the neck line with lace pattern, knit the right side first. If the yarn end is on the left side, knit one more row and place the K CARRIAGE at the right side.
- ★ This method can be used not only for lace pattern but also for plain stitch and other pattern knitting.

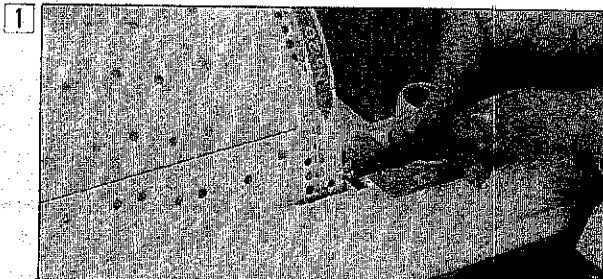

Before you start knitting the first side, mark on the PUNCH CARD so that you can return to the exact row when you knit the other side.

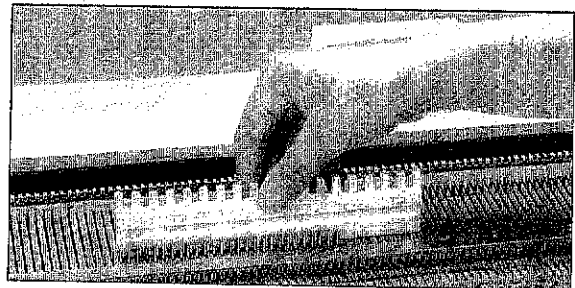

Bring forward to position E all the needles for the parts ② and ③ on the opposite side of the K CARRIAGE, by using the 1/1 NEEDLE PUSHER. These needles will not knit.

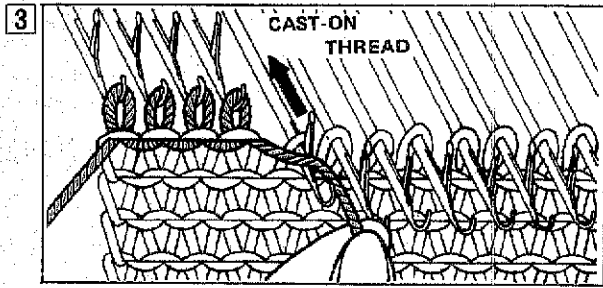

3) Hang the CAST-ON THREAD on the hooks of the needles in position E.

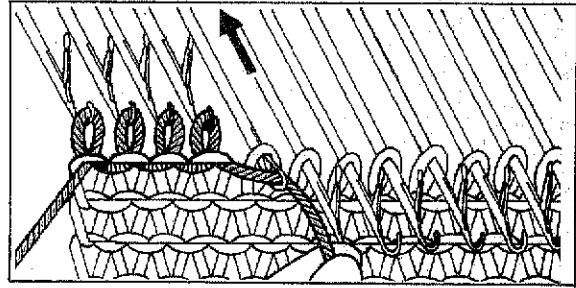

2) Bring them back to position A one by one.

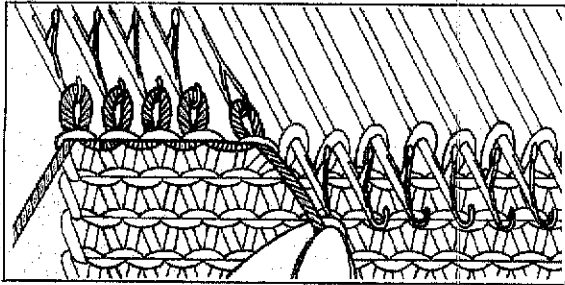

3) At this time, make sure that the CAST-ON THREAD is between hook and latch of the needle to avoid dropping the stitches.

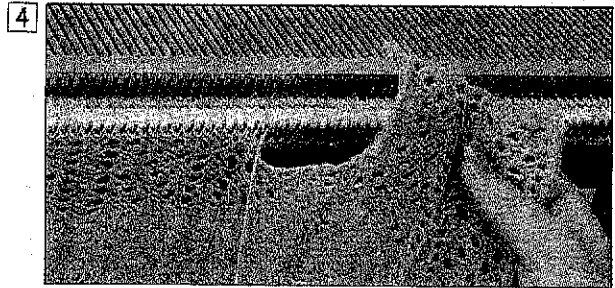

Knit the right side (Part ①) with lace pattern.

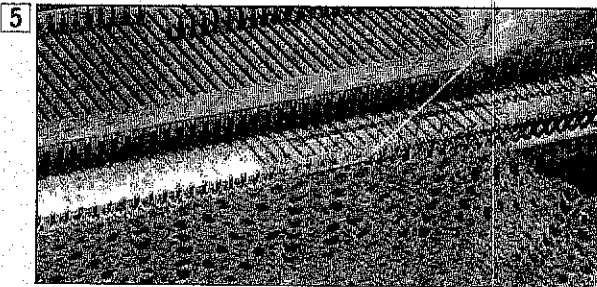

When part ① is completed, transfer the stitches for part ② and ③ from needles in position A to the hooks of the needles by pulling the CAST-ON THREAD and place them in position B.

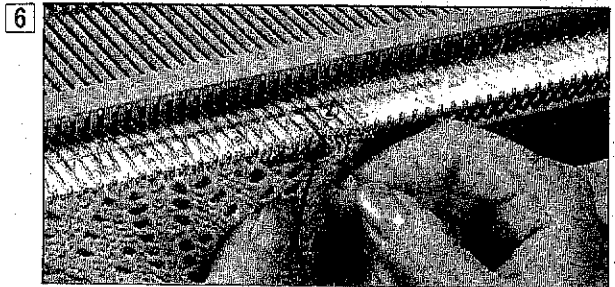

Leaving the needle for part ③ in the position B, bind off the center neck line stitches for part ②

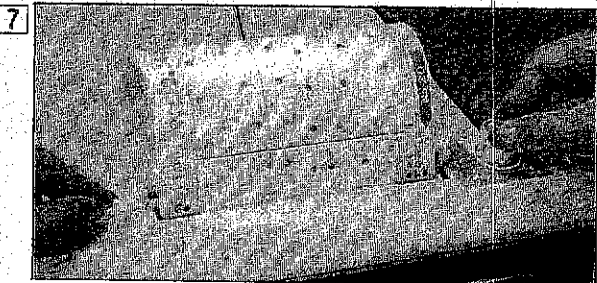

Returns the PUNCH CARD to the mark which was put previously.

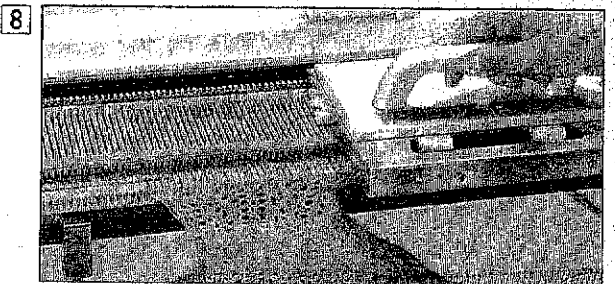

Knit the left side (Part ③) with lace pattern.

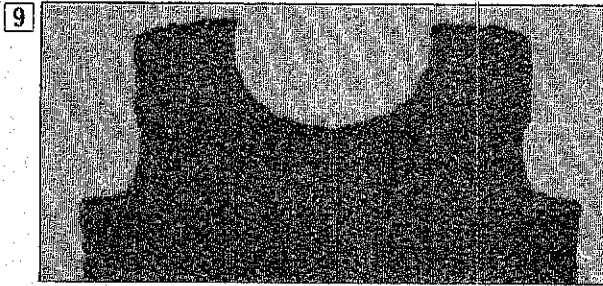

9 The neck line is completed.

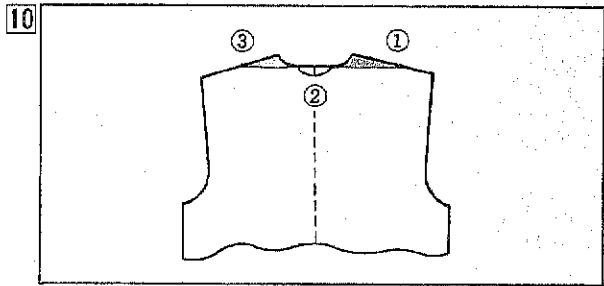

10 Knit the back in the same way.

9-6. SEWING PROCEDURE

9-6-1. Baste the knitting with binding wire and/or basting thread

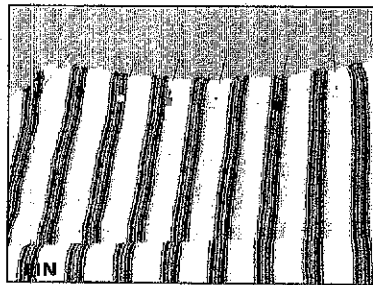

Pin the parts to be basted.

In order to produce a neat garment easily, it is recommendable to use a sewing machine for all necessary sewing.

As only straight stitch sewing is necessary, any type of sewing machine can be used.

Stretchy thread of the same color as the yarn used for knitting is most suitable for sewing (or silk thread can be also used.)

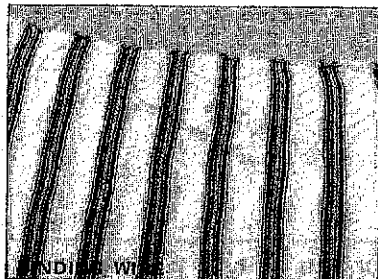

Baste the parts with the binding wire included with KL116 (Knit Leader) as accessory or basting thread.

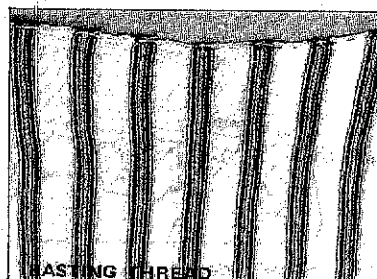

After basting, sew with a sewing machine. Slowly and naturally sew with a slight push along the basted edge, leaving a space of about 3-5 mm.

9-6-2. Sewing procedure

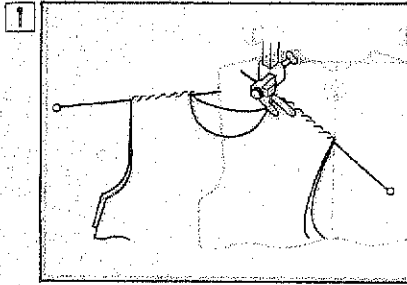

Shoulders (right and left)

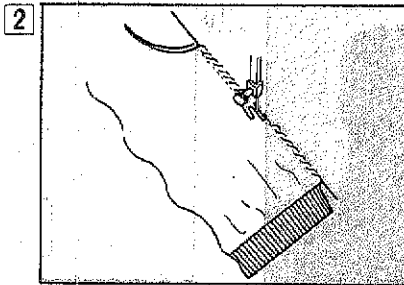

Sides

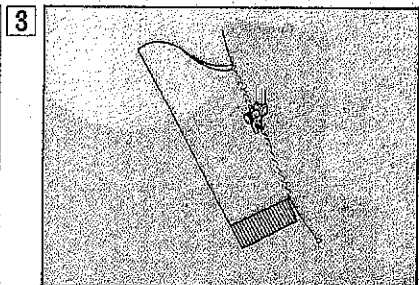

Sleeves

* Sew ribbing together by hand.

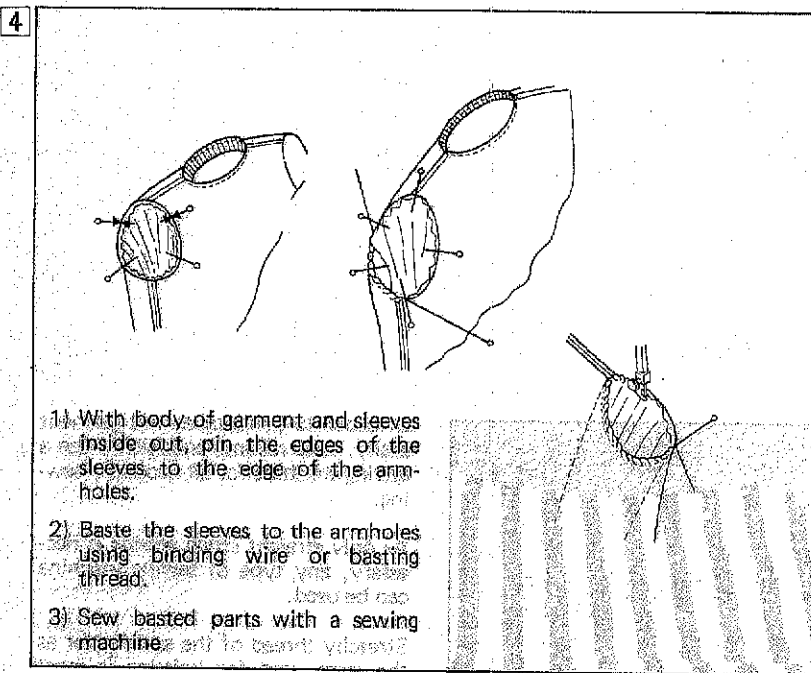

- 1) With body of garment and sleeves inside out, pin the edges of the sleeves to the edge of the armholes.
- 2) Baste the sleeves to the armholes using binding wire or basting thread.
- 3) Sew basted parts with a sewing machine.

Attach sleeves to armholes.

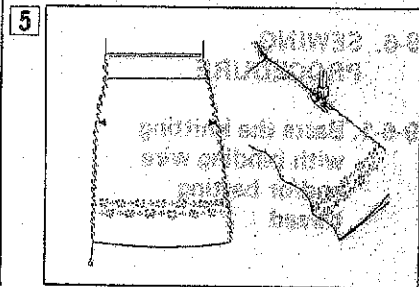

Skirt.

9-7. CLEANING AND MAINTENANCE

9-7-1. Replacing a needle

Needles with damaged latches will cause faulty knitting or dropped stitches and therefore must be changed.

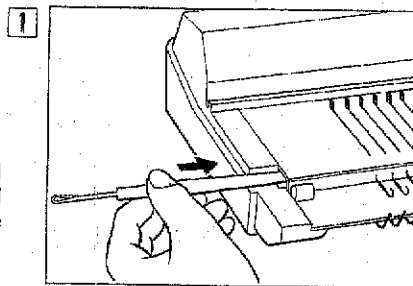

Push either side of the SPONGE BAR with the end of the LATCH TOOL until it comes out from the other end.

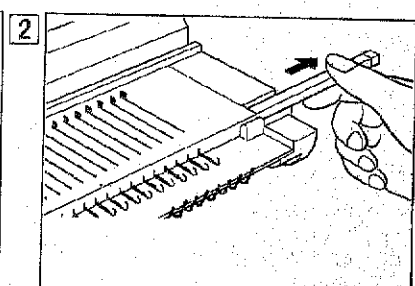

Draw it by hand from the knitter until the needle you wish to change is free.

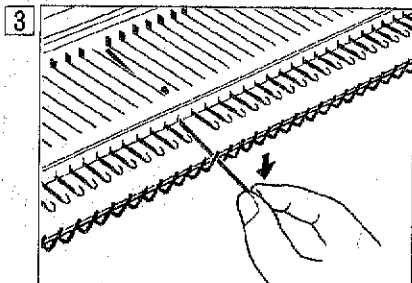

Pull the needle forward as far as it will go. Push down the hook of the needle until shank end of the needle rises clear of the needle bed.

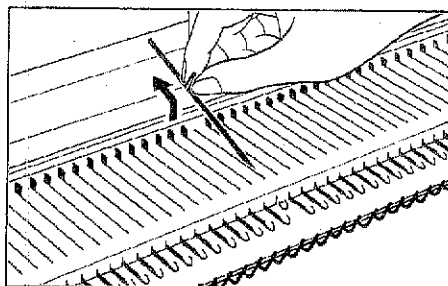

Grasp the shank end and take it out.

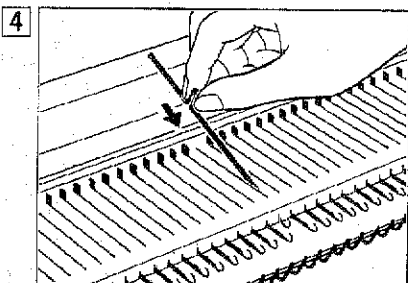

Replace it with a new needle by holding it with fatch opened.

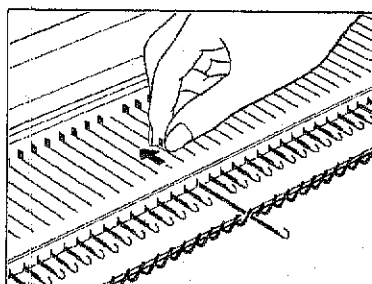

Push the Needle back to position A.

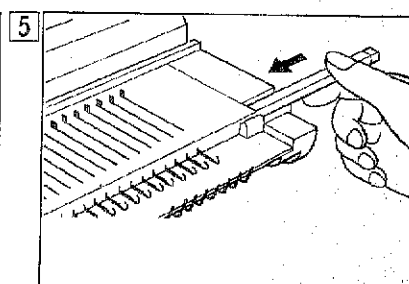

Push the SPONGE BAR back into place by pushing down the needle hooks as they are lifted up.

9-7-2. Cleaning and maintenance

Before folding up your machine, you should clean your machine with a soft dry cloth. The metal parts should be oiled regularly.

When you use your machine after it has not been in use for a long period, wipe your machine with oiled cloth and please take care not to over-oil before using. Before you start knitting, knit 20-30 rows with waste yarn to remove old oil.

Oil the following parts lightly before knitting.

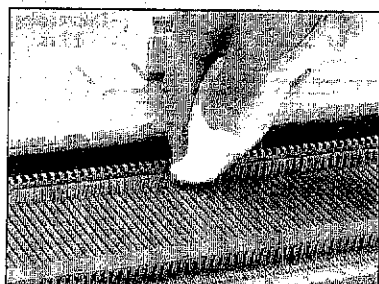
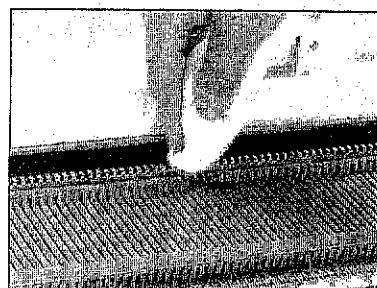
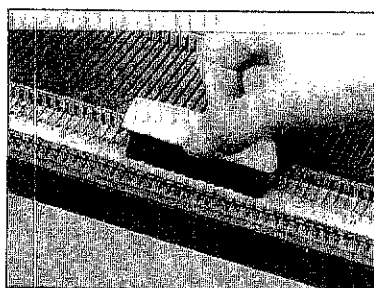

Butts of the Needles.

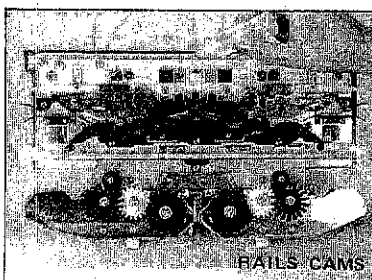

FRONT and REAR feet of the K CARRIAGE.
RAILS CAMS.

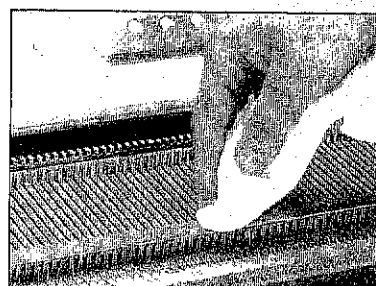

Front and REAR RAILS of the needle bed.

10. CONSIGLI UTILI

10-1. PARTIAL KNITTING (Plain Knitting & Pattern Knitting)

When you knit socks, skirts, darts, etc., do partial knitting.

- ➡ DECREASING STITCHES
- ➡ INCREASING STITCHES

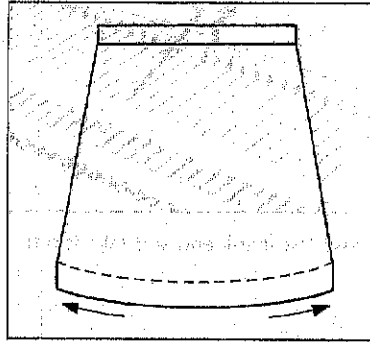

Skirt

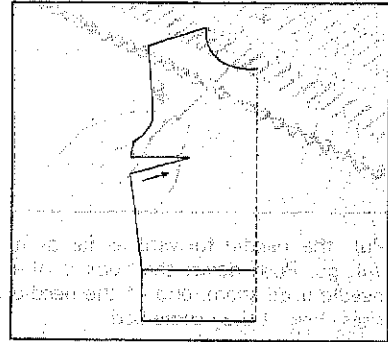

Dart

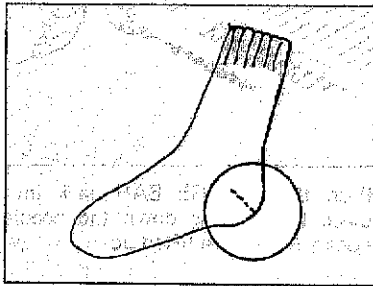

Socks

* Let's knit the heel with Partial Knitting.

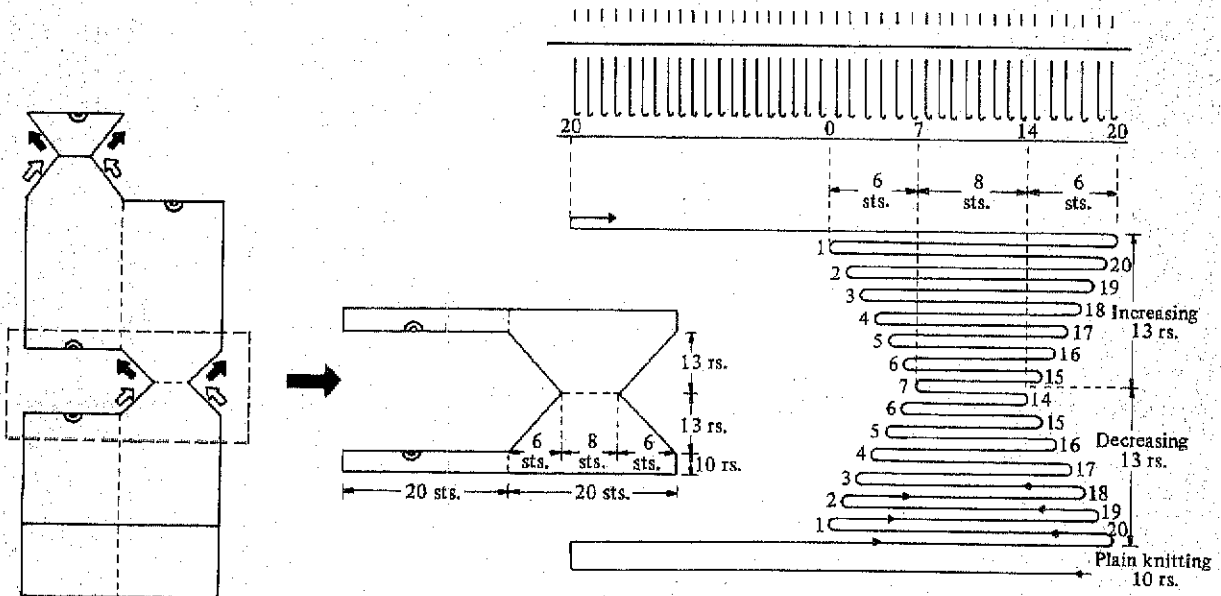

10-1-1. Decreasing stitches

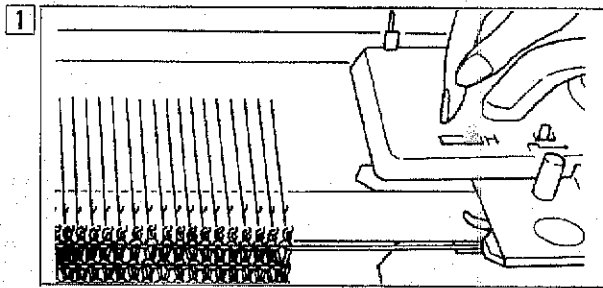

Bring forward 20 needles on either side of the center mark "0", knit 10 rows of Plain Knitting and place the K CARRIAGE on the right side of the machine. Then, set the HOLDING CAM LEVER of the K CARRIAGE to position H.

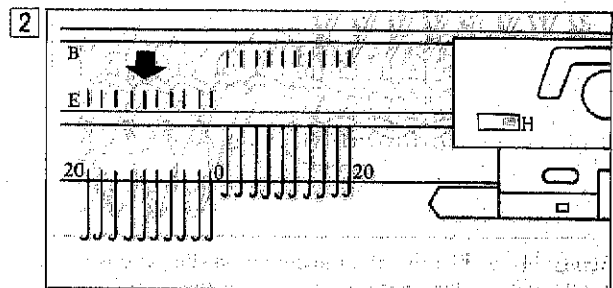

On the opposite side of the K CARRIAGE, bring forward 20 needles to position E as above figure. (These needles will not knit.)

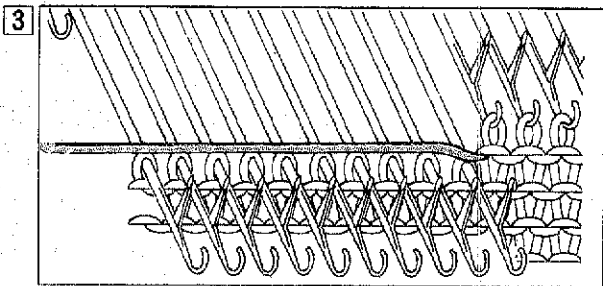

Knit one row. The yarn lies across on the stem of the position E needles at that time.

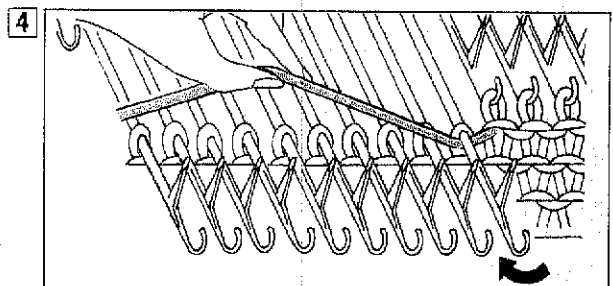

For stopping the gap which appears between stitch of position B and E, pass the yarn under the stem of the first needle at position E.

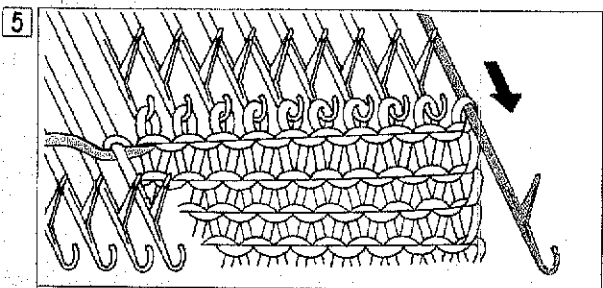

On the opposite side of the K CARRIAGE, bring forward one needle to position E by hand, which will be decreased.

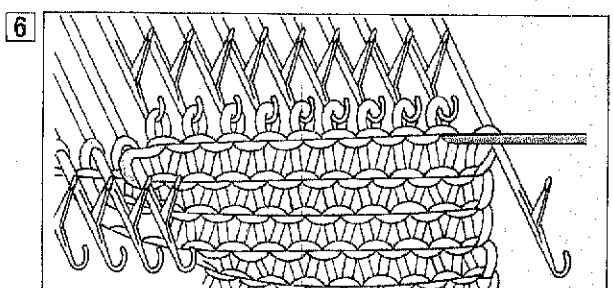

Knit one row.

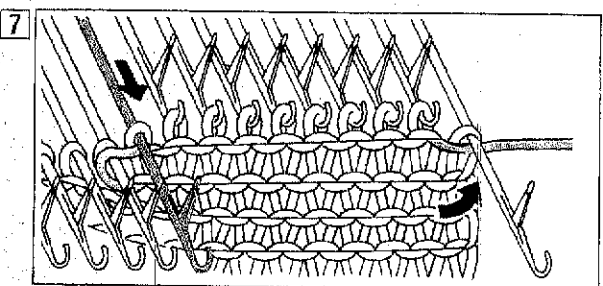

Pass the yarn under the stem of the position E needle. Then, on the opposite side of the K CARRIAGE, bring forward one needle to be decreased to position E.

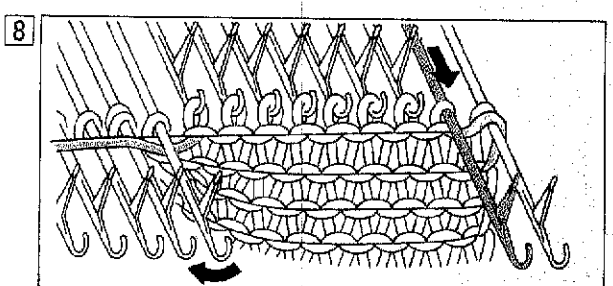

Knit one row.

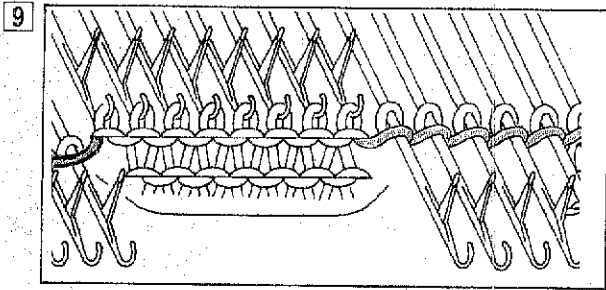

Repeat **4** ~ **8** until the remaining needles at position B will be 8 stitches, and knit one row as the finish.
(K CARRIAGE is on the left side of the machine at that time.)

10-1-2. Increasing stitches

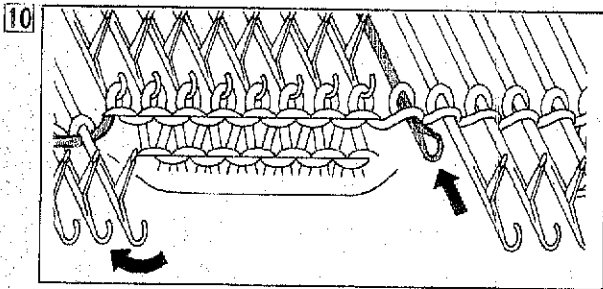

Now, start Increasing Stitches. Pass the yarn at the K CARRIAGE's side under the stem of the first needle at position E. Then, push back to position D first needle on the opposite side of the K CARRIAGE. (This stitch will be knitted.) Take care not to drop the stitch.

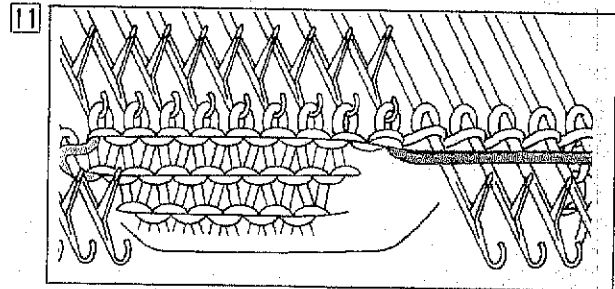

Knit one row.

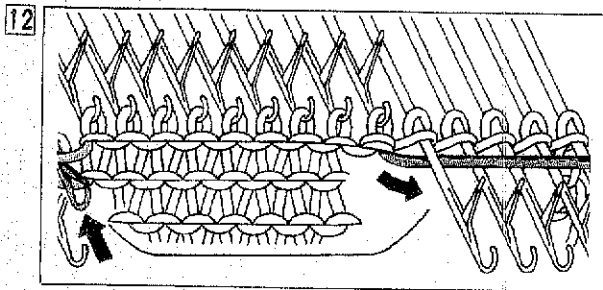

Repeat **10** but notice that the K CARRIAGE is now on the opposite side of the position of **10**.

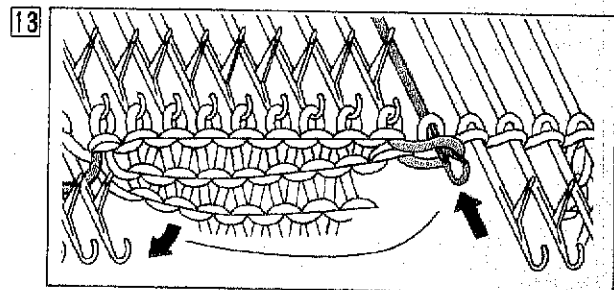

Knit one row.

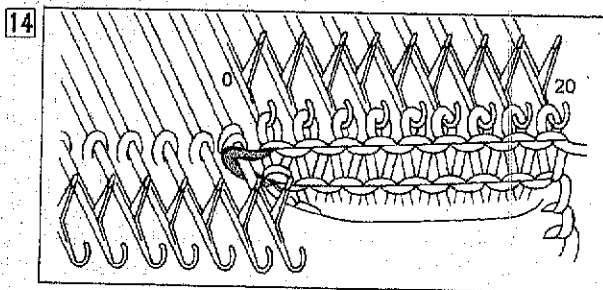

Repeat **10** ~ **13** until the needles at position B will be 20 stitches, and knit one row as the finish.
(K CARRIAGE is on the right side of the machine at that time.)

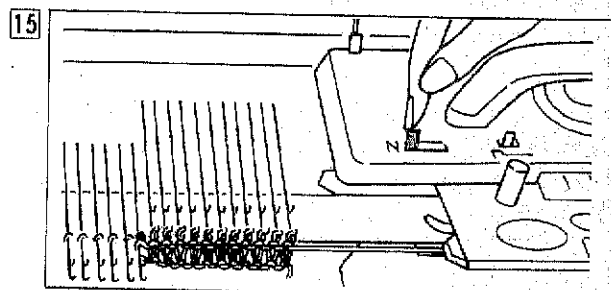

When the Partial Knitting is completed, change the HOLDING CAM LEVER to position N, and knit 10 rows of plain knitting.
Now, the heel of the socks is completed.

10-2. PARTIAL KNITTING (Lace Pattern Knitting)

10-2-1. Decreasing stitches

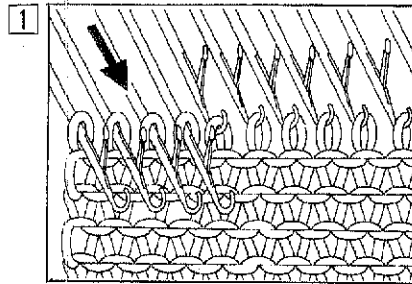

Bring forward the needles you want to decrease to position E.

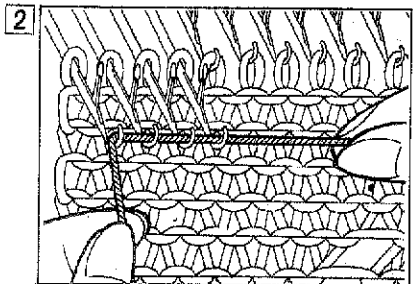

Lay the CAST-ON THREAD on the hook of the needles.

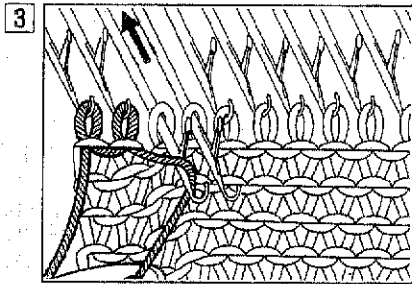

Make sure that the CAST-ON THREAD is in the hooks of the needles completely, and bring back the needles one by one to position A. At this time, take care not to drop the stitches.

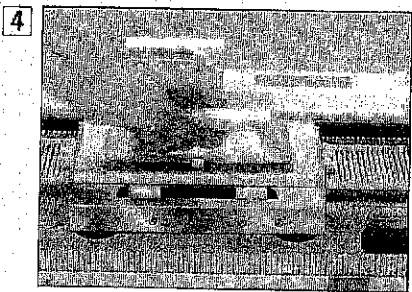
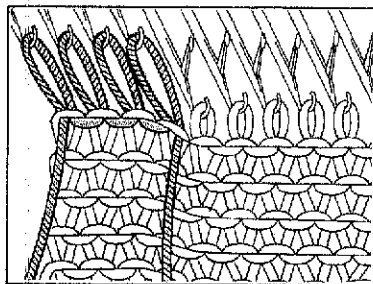

Operate the L CARRIAGE and the K CARRIAGE according to the direction of the arrow on the Punch card.

5 If you want to decrease more stitches, bring back the needles to position A in the same way.

10-2-2. Increasing stitches

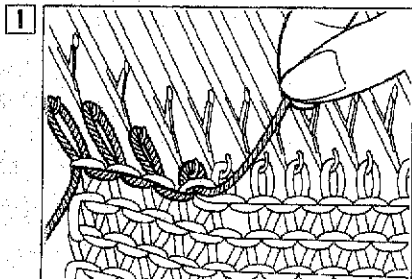

1 Pull up the CAST-ON THREAD slightly to remove it from the needles on position A, transferring the stitches to the hooks of the needles. Then place the needles to position B.

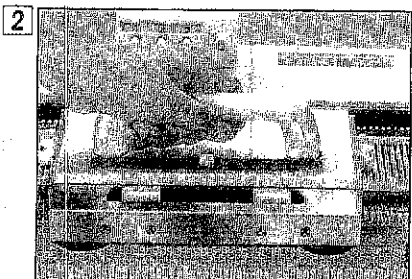

2 Operate the L and the K carriage according to the direction of the arrow on the Puch card.

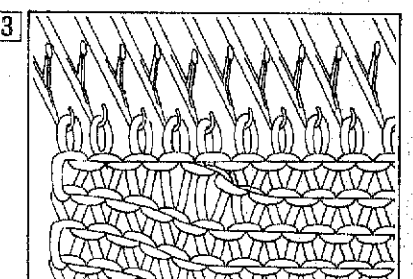

3 If you want to increase more stitches, transfer the stitches to the hooks of the needles in the same way and knit again.

You have increased stitches in partial knitting.

10-3. TUBE KNITTING

The tube knitting is a kind of Skip stitch knitting. Seamless tube can be knitted.

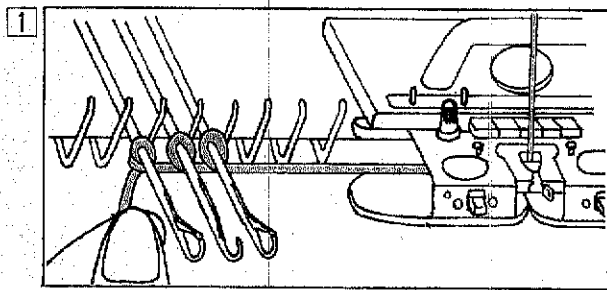

Cast-on 3 or 4 needles by hand method. (See P. 23)

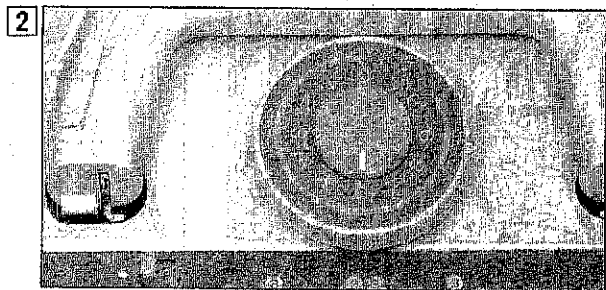

It is recommended to use one number lower than original tension.

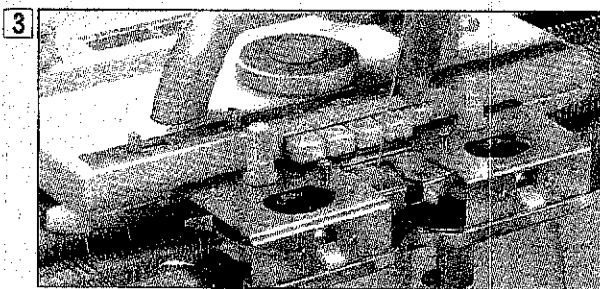

Depress right PART button.

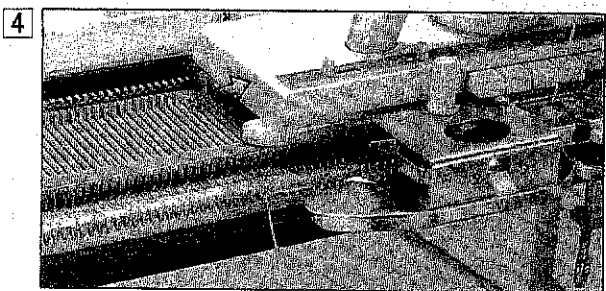

Pull down the fabric by left hand, and move the carriage by right hand.

