

Instruction manual for knitting machine

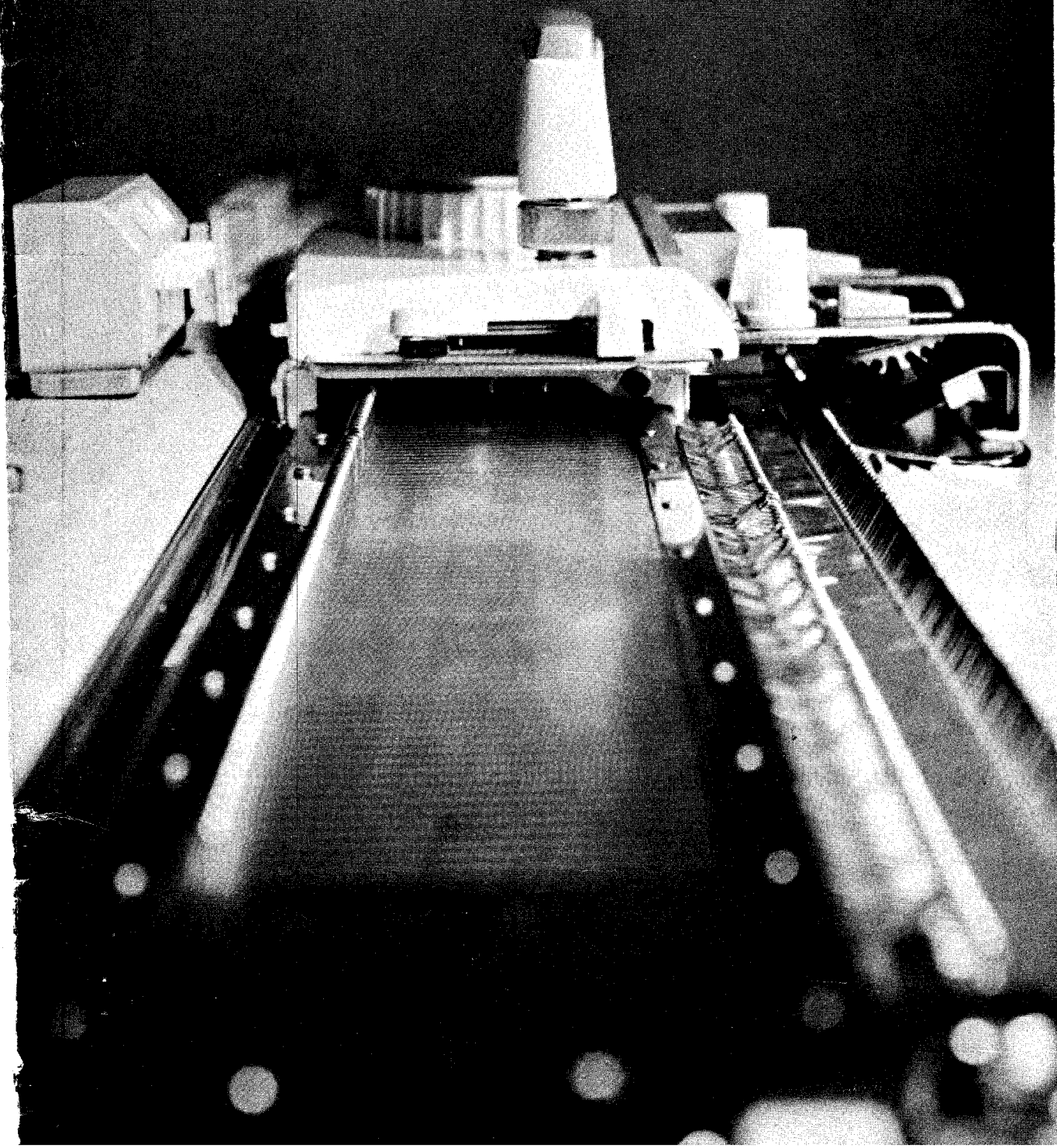

Instruction Manual for the Knitting Machine

Illustrations throughout this book are of the 588, but bearing in mind the slight differences between models this manual is valid for all of them.

N.B. The accessory list is for the 588 ONLY!

For KH-552 Knitting Machine;

Instructions "HOW TO WEAVE ON YOUR MACHINE" and "AUTOMATIC LACE PATTERNS" on page 45 to 55 are not applicable for model KH-552.

You have now become the proud owner of one of the most advanced knitting machines that is available today. We wish to ensure that you will receive every possible benefit and enjoyment from using this machine and have taken great care in producing a simple step by step guide which has been designed by a team of Jones Knitting Instructresses, drawn from their previous experience in conducting Knitting Schools.

Learning to knit this new modern way is simple, but like anything else it requires a little patience and some practice. We recommend that you take one step at a time and do not proceed to the next section until you are satisfied that you have grasped the previous one. The first part of this book is a step by step guide on setting up your machine. Follow the clear instructions and illustrations each time you set up your machine and you will soon be able to do it without having to refer to the manual. The rest of the book explains how to produce the various shapings

automatic patterns. You will be delighted when you see how easy it is to knit all the exciting Fair Isle, weaving or lacy patterns – completely automatically. **REMEMBER!** We are here to help you as much as we can with your knitting machine and are always available to offer additional advice or suggestions that may not be absolutely clear from the instruction book. Please do not hesitate to write to our Knitting Advisory Department for any assistance that you may require.

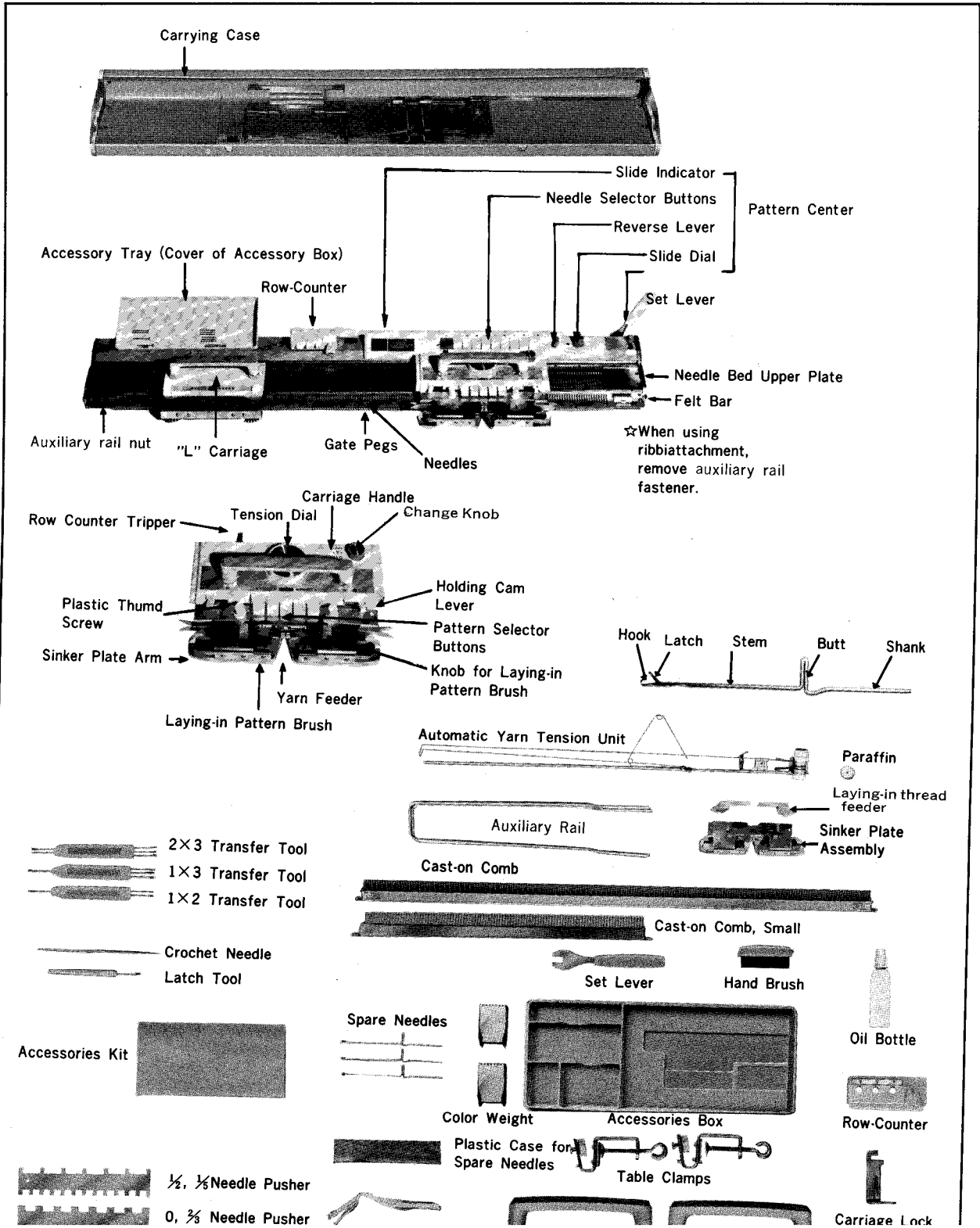

Setting up your machine

3

Place the machine on a firm table, with the carrying case handle away from you. Unlock the catches on either side of the handle. (See Fig. 2).

Lift the upper case slightly, and pull towards you to release the lid. (See Fig. 3).

Remove the accessory box on the needle bed, by lifting up the front first. (See Fig. 4).

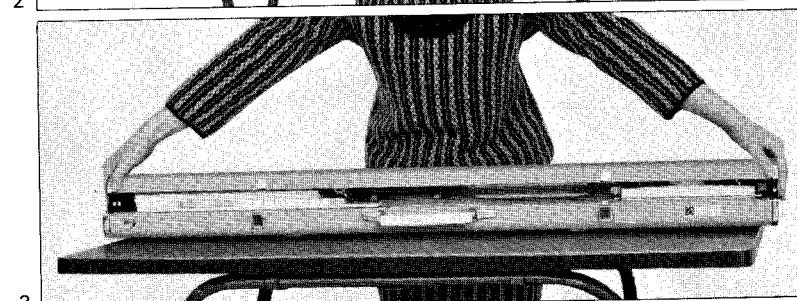
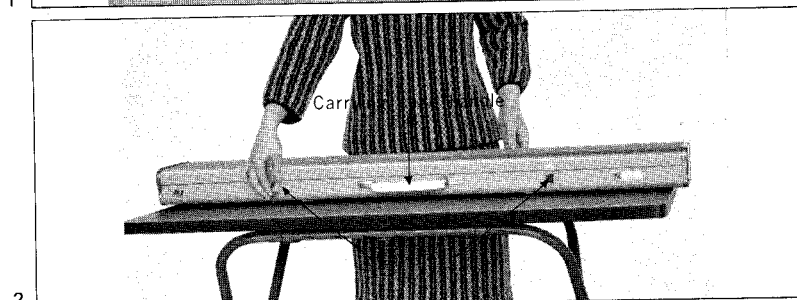
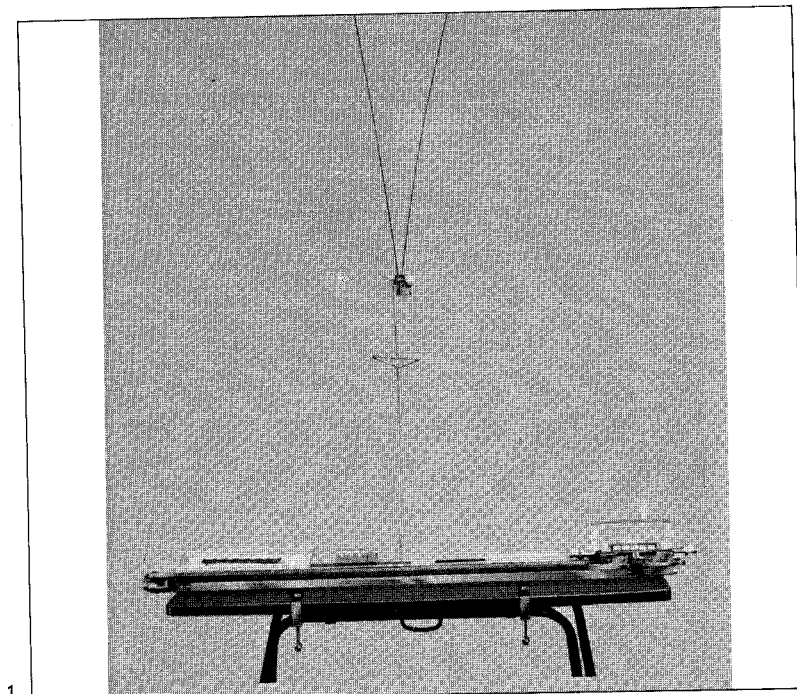

Take the two clamps out of the accessory box – raise the front of the machine – and insert the head of the clamp into the aperture. (See Fig. 5).

Now pull the clamp upwards and turn the nut in a clockwise direction until it is secure. Fit the second clamp in the same way. (See Fig. 6).

Fasten the knitter to the table by tightening the table clamp screws. The rubber pads will prevent the table top surface from getting scratched. (See Fig. 7).

Remove the carriage lock. (See Fig. 8).

NOW YOUR MACHINE IS SECURED TO THE TABLE – AND YOU ARE READY TO START FITTING THE ATTACHMENTS.

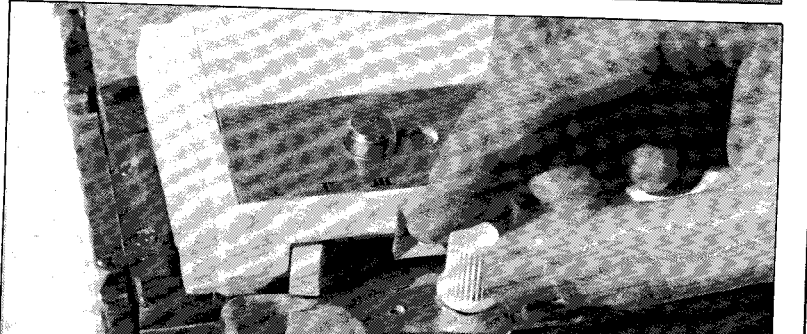
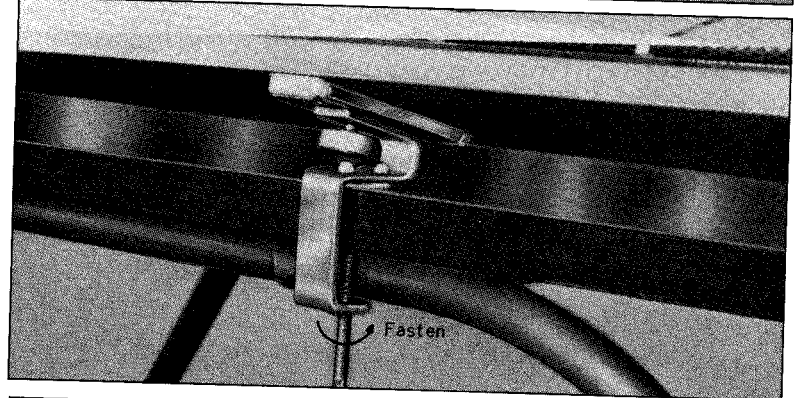
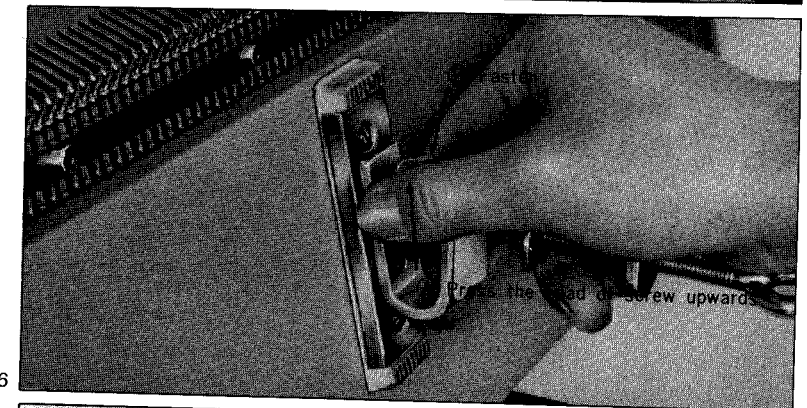
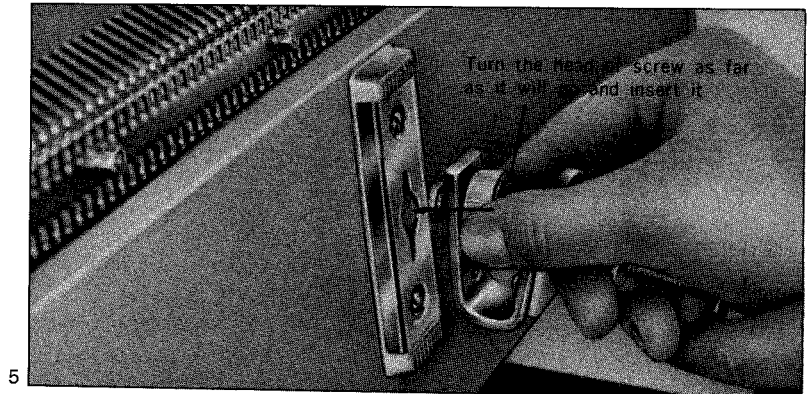

FOR MODELS 585 & 588 ONLY

Press down the spring to release the Lacy saddle, and remove it from the carrying case. (See Fig. 9).

Press down the spring in the centre, and remove the sinker plate assembly and the Yarn Tension Unit. (See Fig. 10).

SETTING UP THE CARRIAGE

Slide the carriage to the centre of the machine. (Before doing so push back the butts of all the needles as far as they will go. Loosen the white plastic thumb screws on the carriage, and insert the sinker plate unit. Push it back as far as it will go, and tighten the thumb screws securely. Make sure that the raised metal studs line up with the holes in the sinker plate unit. (See Fig. 11).

CHECK THAT THE CARRIAGE MOVES FROM SIDE TO SIDE FREELY. (To do so all needles must be back in Position A).

Fasten the handle onto the carriage (See Fig. 12).

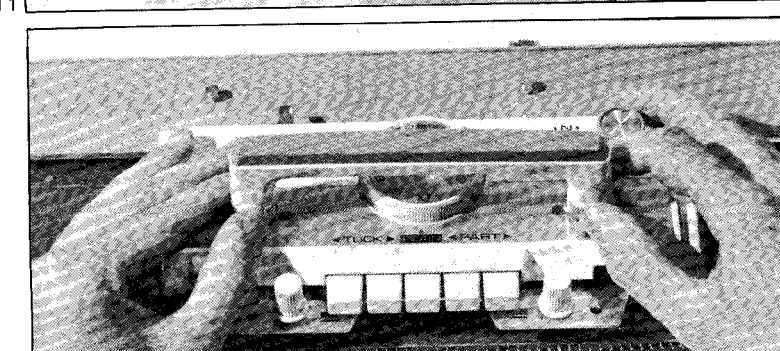
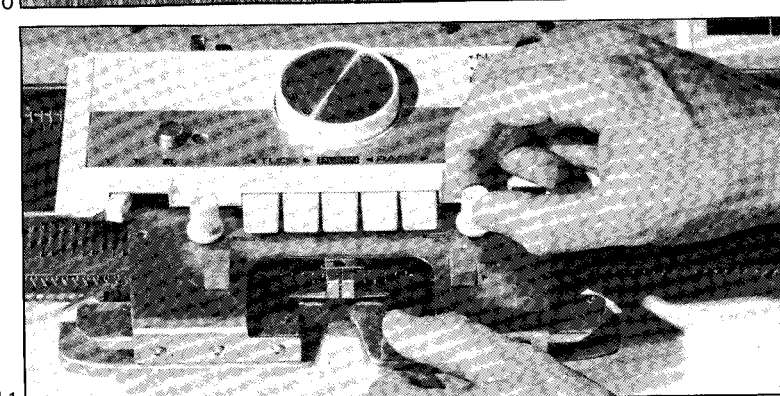
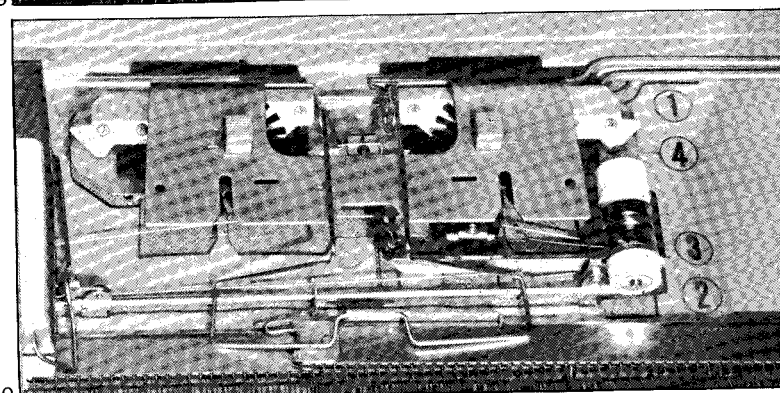
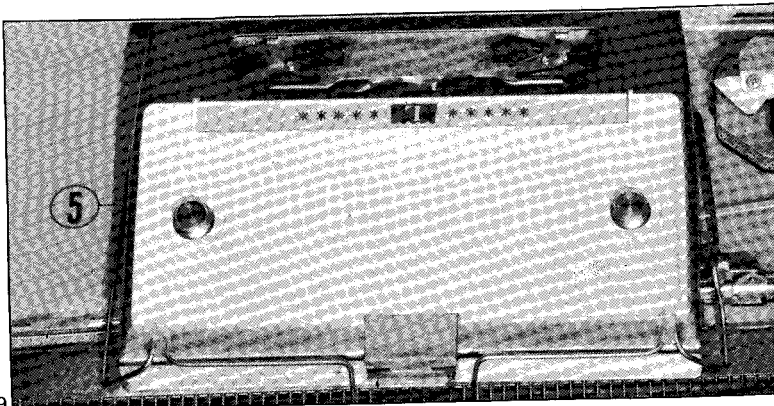

6

Set the row counter onto the two studs – and push it away from you. (See Fig. 13).

Fit the set lever onto the shaft at the rear right of the needle bed. (See Fig. 14).

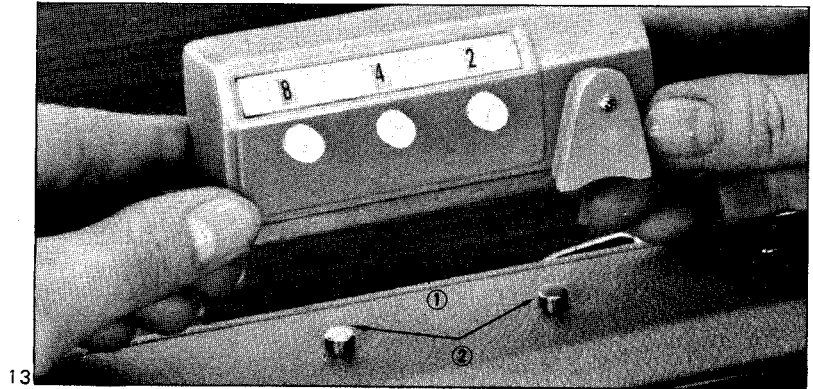

13

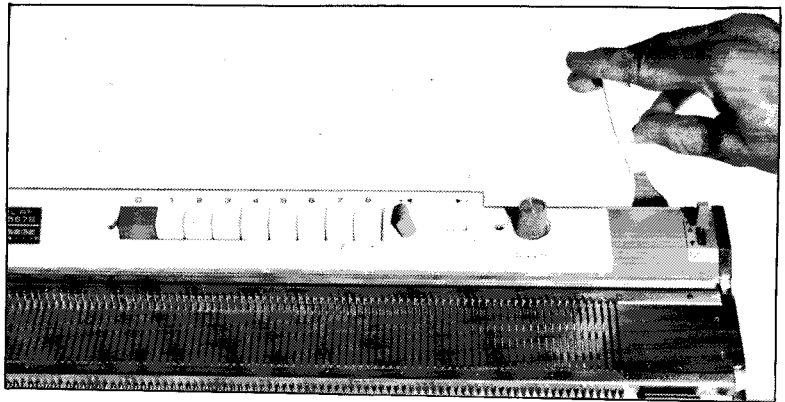

14

Place the accessory tray (lid of accessory box) onto the two studs at the top left of the machine. Insert the studs into the openings and slide the tray as far left as it will go. (See Fig. 19).

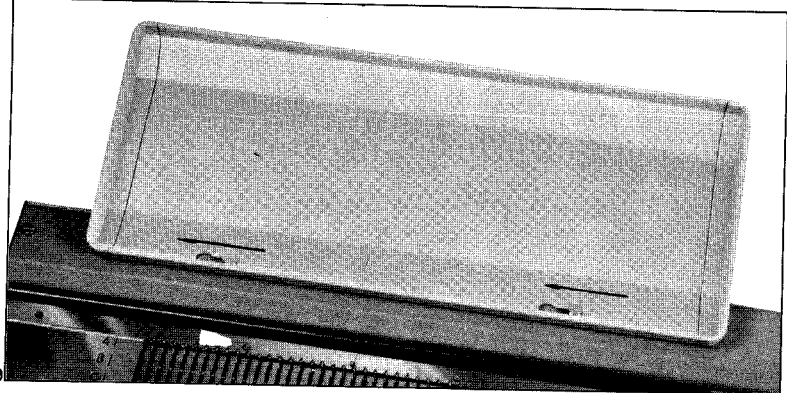

19

Assembling the yarn tension unit

Insert the end of the rod into the stand hole at the centre of the machine. The rear yarn guide should face backwards. (See Fig. 18).

As this was retained by the same spring as the sinker plate unit, it should now be free from the carrying case.

Turn the front guide arm forward in the direction of the red arrow. (See Fig. 15).

Turn back the 'take-up springs' as far as they will go. (See Fig. 16).

Raise the rear arm guide until it is perpendicular to the rod. (See Fig. 17).

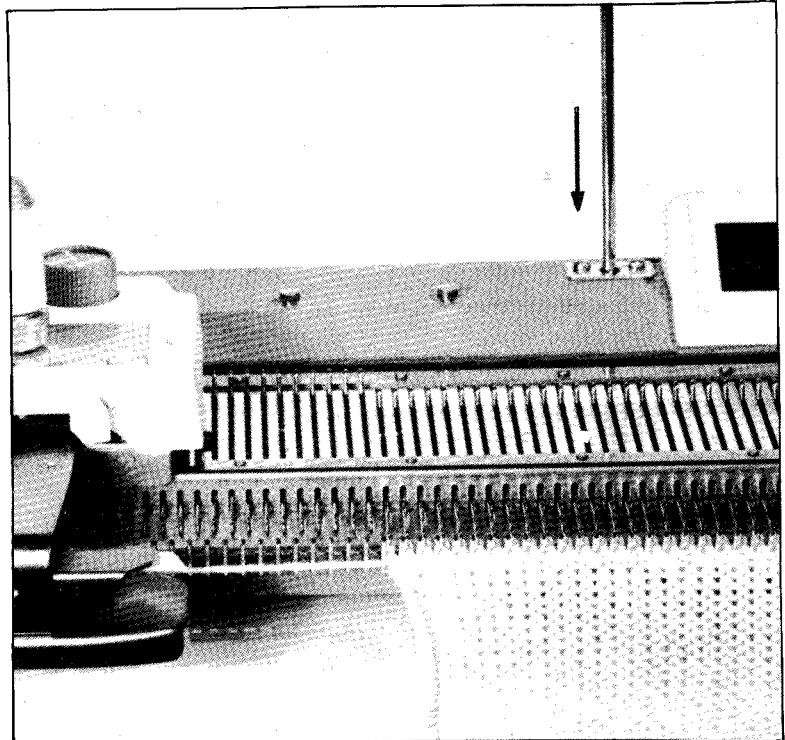

18

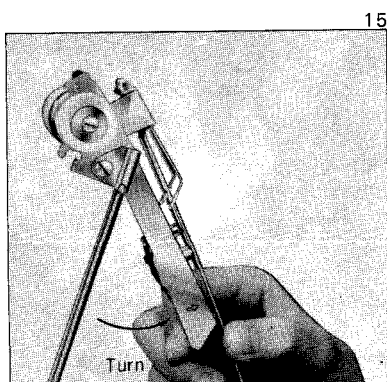

15

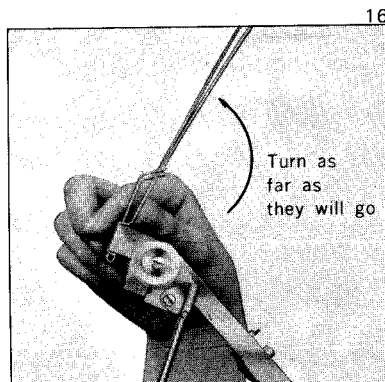

16

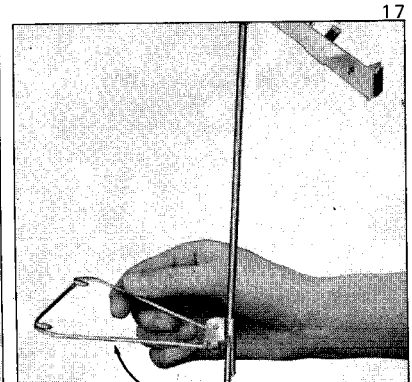

17

Here are a few important points to remember before you start knitting

8

WOOL

There are many different types of wool that can be knitted on your machine—but for the purpose of learning or practicing, it is best to use a standard 3 Ply yarn. Choose a good quality, one that can be knitted over and over again.

WINDING THE WOOL

The wool you purchase will be wound in either balls or hanks, both of which unwind slowly when knitted by hand. Machine knitting is much faster, and requires that the wool be loosely wound so that it unravels freely. You should therefore re-wind all wool into a ball, using a wool winder. This way you can also make sure that there are no knots or flaws in the wool—that you might otherwise discover too late. If you do discover any knots, try to ensure that they come at the end of a row and not in the middle of the knitting. (See Fig. 20).

WAXING THE WOOL

For thicker wools or wool of uneven texture it is recommended that you wax the wool before using. To make this easier for you we have built into the Yarn Tension Unit a special wax stand, which automatically applies a small amount of paraffin wax to the wool as it passes through the unit. Waxing will smooth the small hairs in the wool, and allow it to run through the machine easily. All traces of the wax will disappear after the garment is pressed. (See Fig. 35).

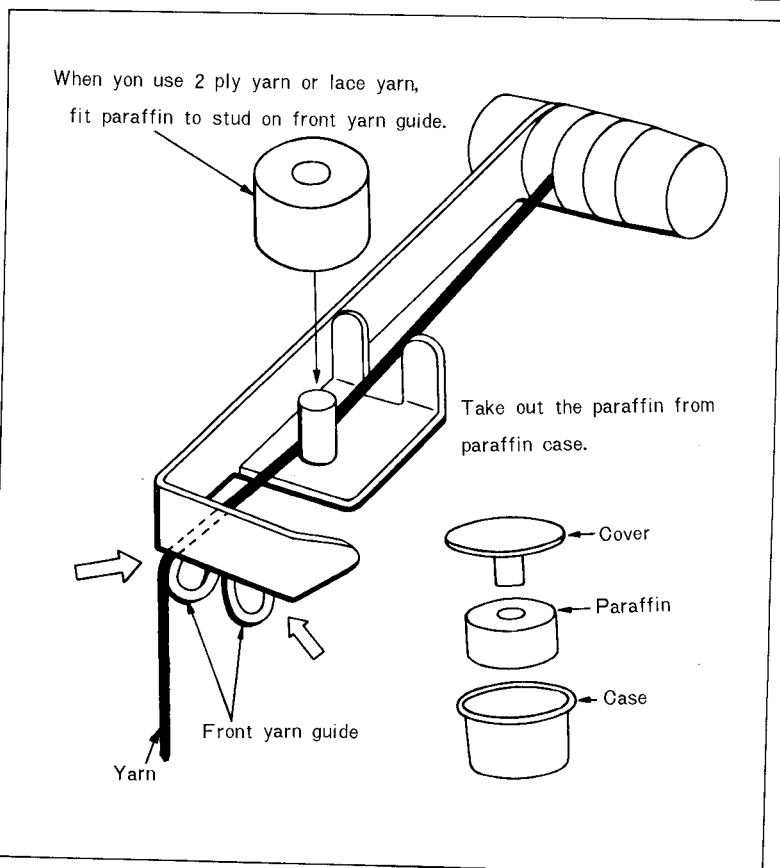
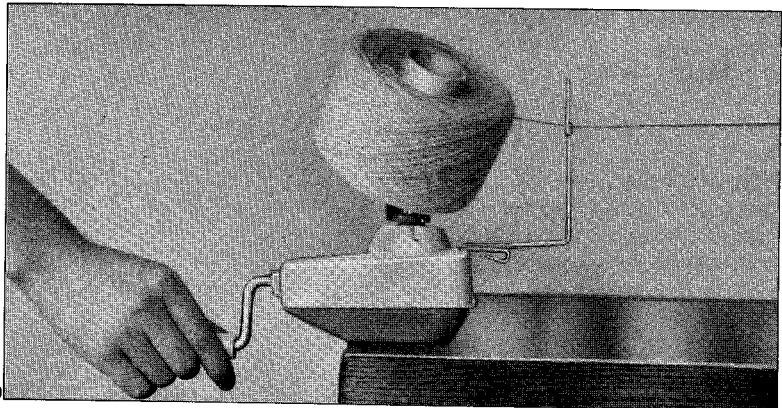

WOOL TENSION

The tension that the wool will feed into the machine at is governed by the unit at the top of the Yarn Tension Unit. The spring discs allow the wool to pass through easily or tightly – depending upon the thickness of the wool. A tight tension (towards the +) is used for thin yarns and a loose tension (towards the —) for thick wools. The tension we recommend for a 3 Ply wool is where the two arrows meet. (See Fig. 21).

21

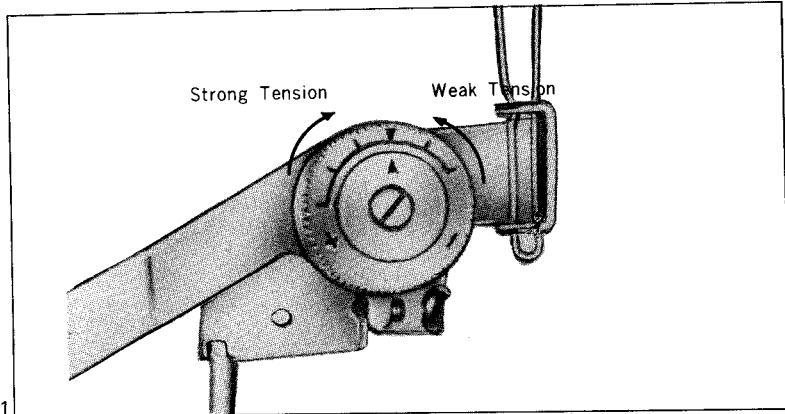

TENSION DIAL

The size of the stitch is determined by the tension setting on the Carriage tension dial. This dial is graduated from 0 to 10, each space being subdivided into three parts. 0 denotes the tightest tension (i.e. the smallest stitch) and 10 the largest tension (i.e. the loosest stitch). The tension at which your garment is to be knitted is usually given in the knitting pattern instructions, but as this is liable to differ for different brands of wool, it is advisable always to knit a tension swatch sample before commencing your garment. (See section on "Knitting your first garment"). (See Fig. 22).

22

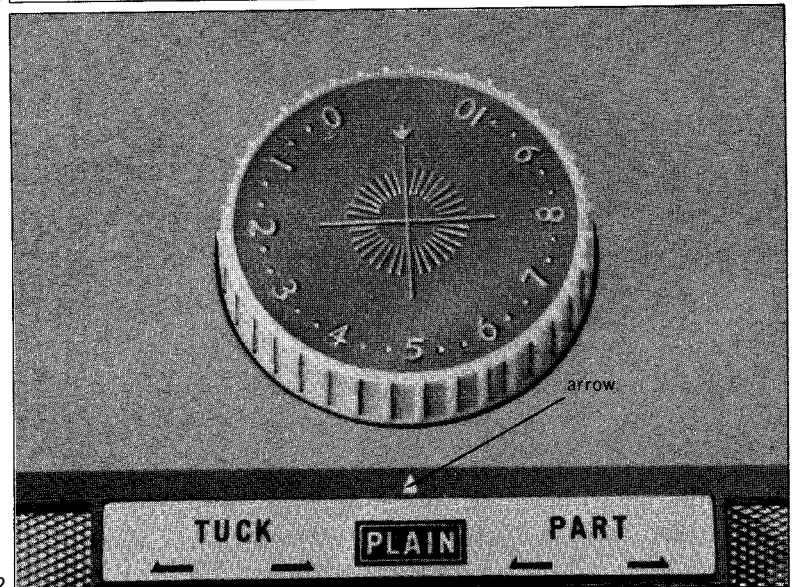

(See Fig. 23).

NEEDLE POSITIONS

On either side of the needle bed there appear the marks A, B, C, D1, D11 & E. These are the five needle positions.

A – Non working position.

Needles will not knit.

B – Working position.

Used for general work.

C, D1, D11, – Pattern, Lacey & Fairisle positions.

Used for various pattern stitches.

E – Holding position.

The stitch will 'hold' on the needle until released. Used for

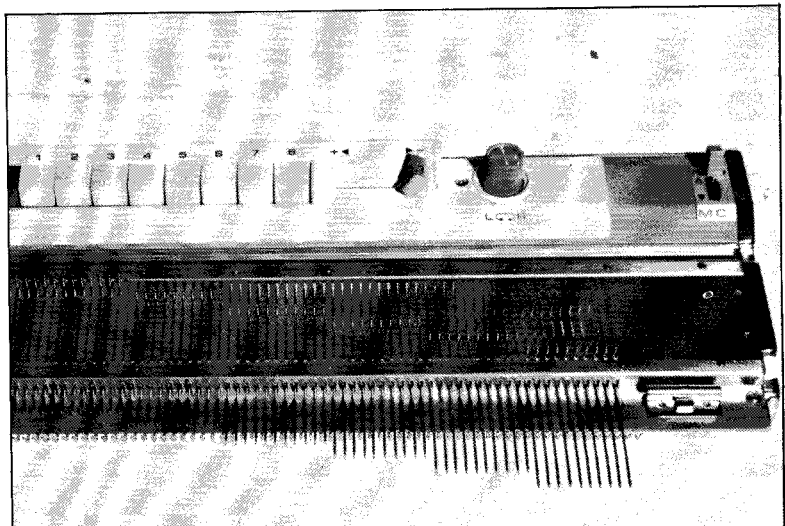

IT IS IMPORTANT TO REMEMBER THAT THE CARRIAGE SHOULD NOT BE MOVED ACROSS THE NEEDLE BED UNLESS ALL THE NEEDLES ARE ALIGNED IN EITHER OF THE FIVE POSITIONS.

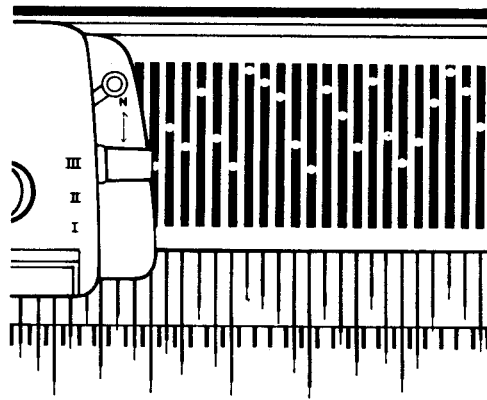

WRONG

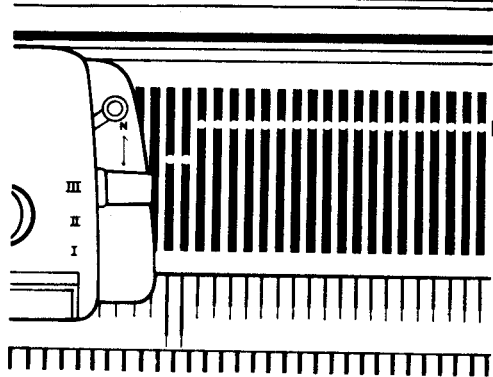

WRONG

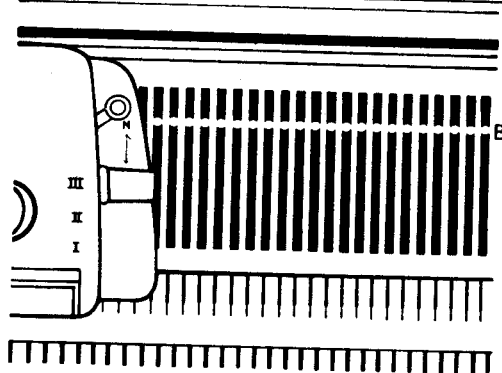

RIGHT

Functions of the carriage

11

The movement of the carriage across the needles in action (Position B), automatically knits each needle in turn ; thereby knitting one row. Once the carriage has been moved across the needles in one direction, it cannot be returned until that row has been completed. At the end of a row you will hear a "click" from the carriage, which signifies that the row has been completed and you can return.

It is advisable not to move the carriage too far away from the end needles after completing a row, as this will tend to slacken the tension in the springs on the return movement.

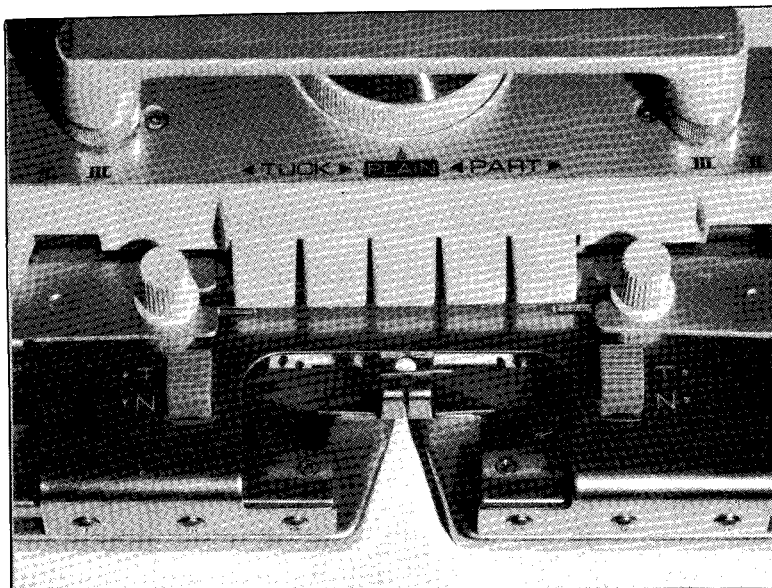

CARRIAGE BUTTONS ²⁵

There are five buttons on the front of the carriage. They are used for various stitch patterns to set the carriage to enable it to knit various stitches. The arrow above the button shows that the carriage is set for that direction. If both buttons are depressed together, the carriage will be set for both directions.

PART : These buttons are used mainly for fair-isle and similar patterns. When using the PART buttons, both H.C.L's must be on Position 1. If both buttons are in, and the needles are not set, the carriage will move across needles without knitting the stitches.

PLAIN : This button is pressed only to cancel any of the other buttons previously set. It does not remain in.

TUCK : These buttons are used to form 'tucking' stitch patterns. When using them, the H.C.L's must be on Position 1. (See Fig. 25).

HOLDING CAM LEVERS (H.C.L.'s.)

The H.C.L.'s on either side of the carriage have three positions marked on the carriage, 1, 11 and 111.

1 : All needles set forward to C, D1, D11 or E positions will return to working position B.

11 : Intermediate position. This position is used when both 1 and 111 positions are to be used (i.e., when knitting a 'V' neck with a pattern).

111. Holding position. Any needles brought forward to Positions C, D or E will not knit if the H.C.L. closest to the knitting is on 111.

WEAVING LEVERS 580, 585 ONLY

The weaving levers are behind the H.C.L.'s at the sides of the carriage, and the weaving buttons are on the top of the sinker plate. If you are weaving in one direction only, then the buttons closest to the knitting must be put in Position 'T' and the lever closest to the knitting also to Position 'T'. To move the weaving lever it must be depressed slightly.

If you are weaving in both directions then both levers and both buttons must be in Position 'T'.

When you are not weaving, but knitting, levers and buttons must be in 'N' position.

CHANGE KNOB 588 ONLY

There are three settings on this control. (See Fig. 26).

- N. For normal knitting, part and tuck patterns.
- T. For laying in or weaving patterns.
- MC. For fairisle. When the change knob is set on MC all the needles knit in position D1. Knitting in this position does not harm the machine but there will be a little more yarn used.

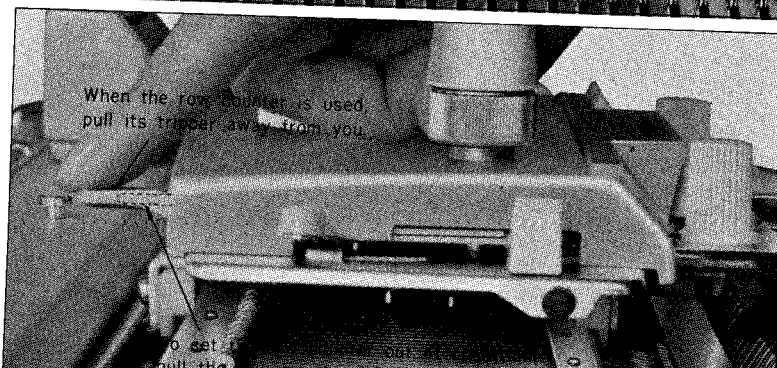
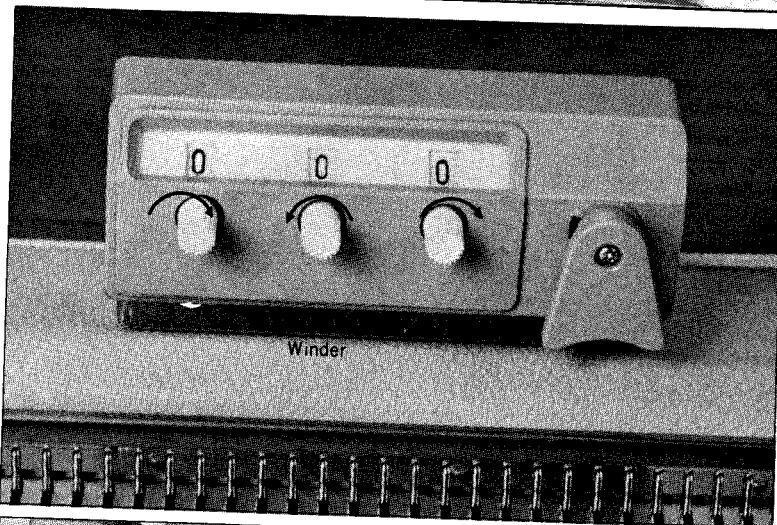
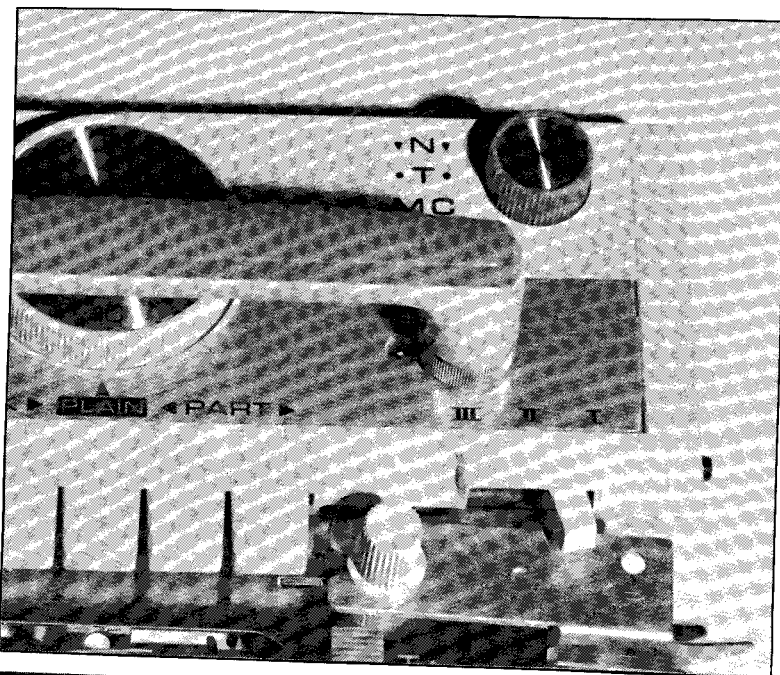

Preparing to knit

ROW COUNTER

The figures on your row counter can be moved to zero by turning the dials anti-clockwise in order from the right (See Fig. 27). When using the row counter pull up the tripper at the back of the carriage. If you do not wish to use the row counter, then push the tripper back into the carriage. (See Fig. 28).

STEP ONE –

THE CARRIAGE. (See Fig. 29). The photo above shows the various controls of the carriage that you should remember the names of.

- (1) Set the tension dial to 7 (for 3-ply wool).
- (2) Push both weaving knobs to N.
- (3) both Holding Cam Levers to Position 1.
- (4) Press centre Carriage Button – PLAIN.
- (5) Change knob to N.
- (6) Move the carriage across to the right side of the machine.

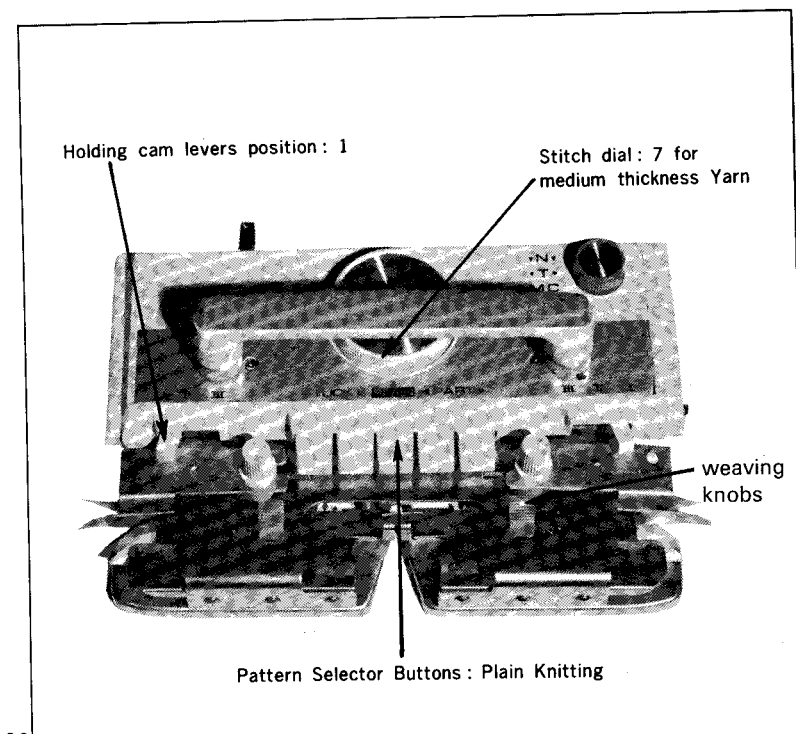

29

STEP TWO –

NEEDLE BED (See Fig. 31).

- (1) Push down the Release Button (0) (NOTE: it does not remain down as the others).
- (2) Set reverse lever to +.
- (3) Turn Slide Dial until the arrow on slide indicator is opposite number 1. (See Fig. 32).
- (4) Bring forward by hand 40 needles to Pos. B, 20 on either side of the centre mark 'O'
- (5) Move the carriage across and back to straighten these needles completely.

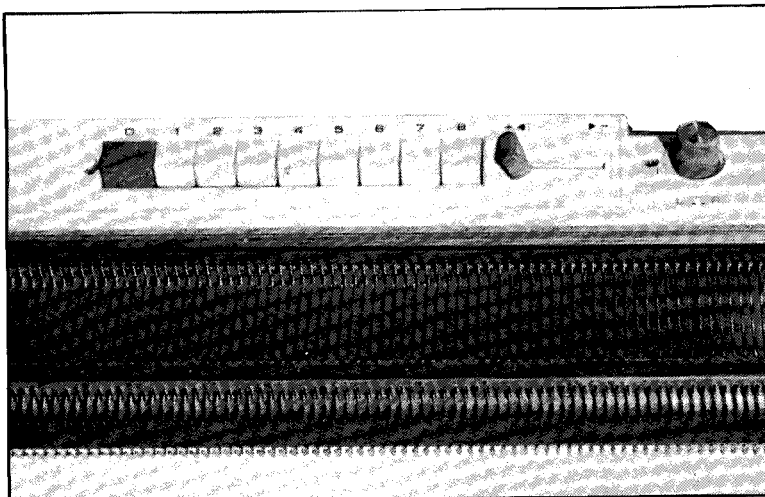

31
32

STEP THREE –

THREADING THE YARN TENSION UNIT (See Figs. 33, 34, 35).

(1) Pass the wool from the ball through the rear yarn guide as shown in fig. 33.

(2) Take the wool in front of the yarn guide and in between either of the two sets of discs, from behind.

(3) Pass the wool through the yarn guide on either side of the centre stud (see Fig. 35). You need not use the wool wax for 3-ply wool.

(4) Thread the front of the yarn guide (see Fig. 35).

(5) Thread the wool into the eyelet of one take up spring (see Fig. 34).

(6) Now clip the wool under the wool holder half way down the rod where it will remain until you are ready to start knitting.

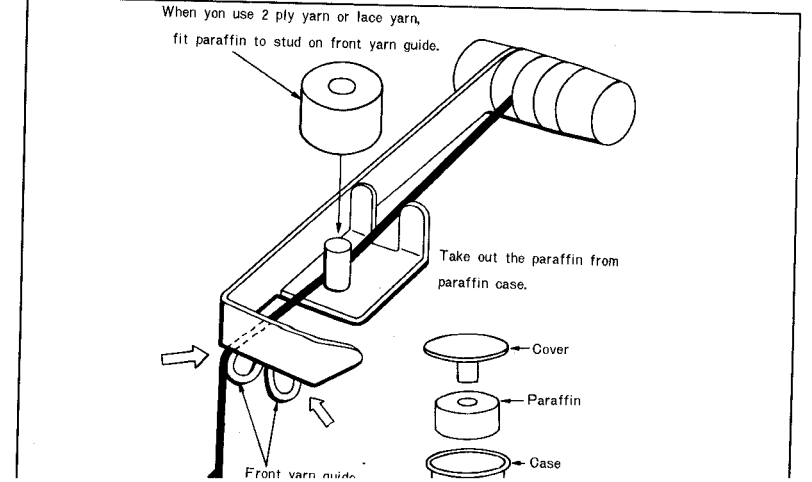
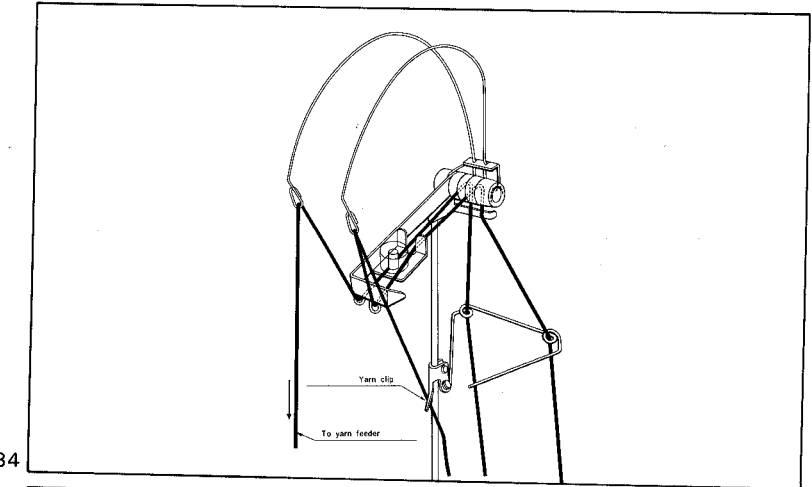
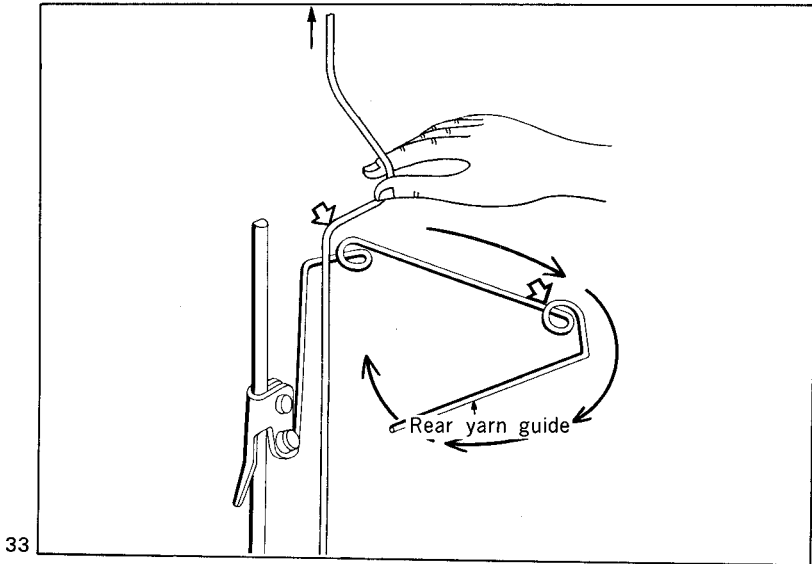

STEP FOUR –**CASTING ON.**

(1) Hang the cast on comb onto the pegs of the needle gate making sure that the clips on the comb slip over the part of the gate peg that is below the needle bed. Use the small cast on comb and centre it between the 50th needle on the right and left. SET THE TENSION DIAL TO No. 7 (3-PLY WOOL) (See Figs. 36 & 37).

(2) Take the end of the wool (which was clipped onto the yarn tension rod) and thread it into the yarn feeder of the carriage. Hold it from below with your left hand and from above with your right. (See Fig. 38).

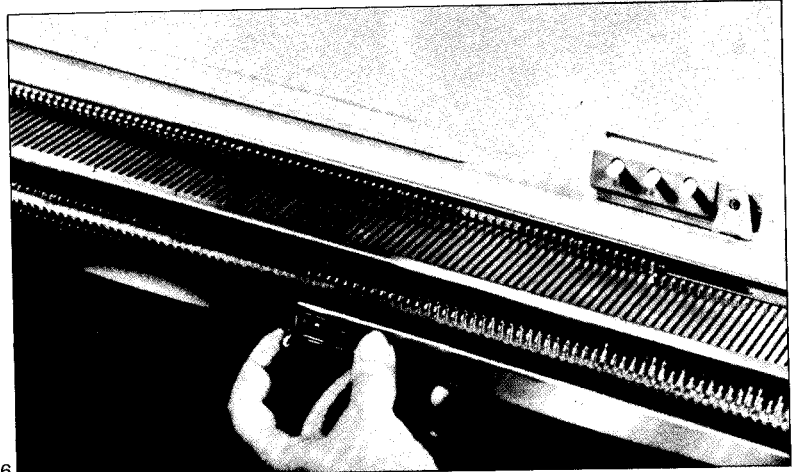

36

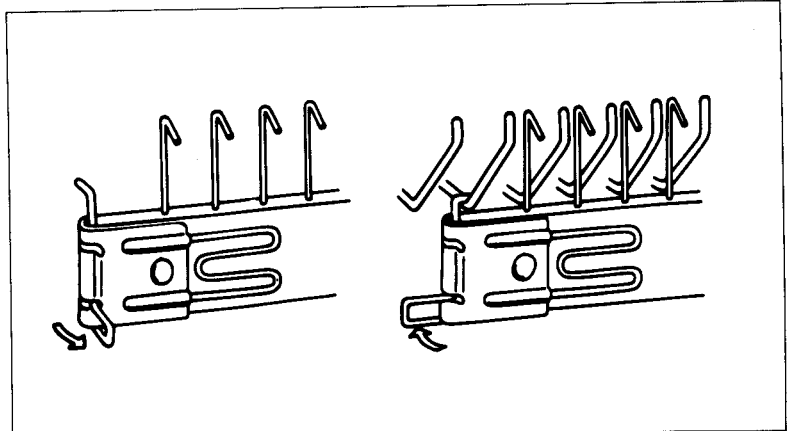

37

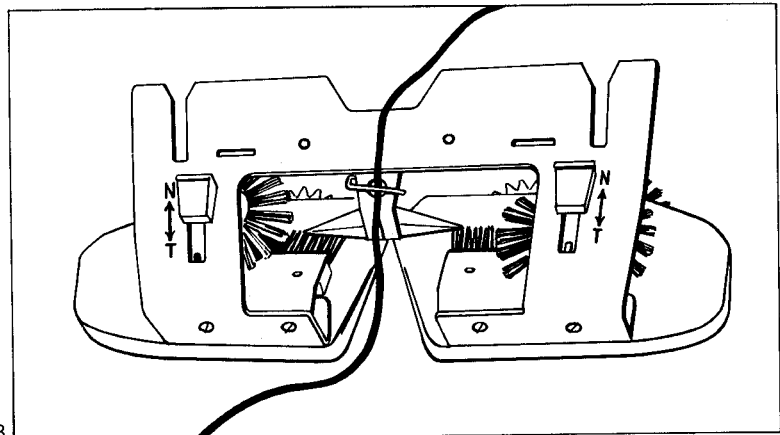

38

(3) Push the wool back into the yarn feeder. It should click into place. (See Fig. 3940).

(4) Continue to hold the wool below with your left hand, and take back any slack wool through the yarn tension unit (i.e., the take up spring should be bent forward).

(5) Still holding the wool below the carriage with your left hand, slide the carriage across the needles with your right hand until you hear a "click".

39

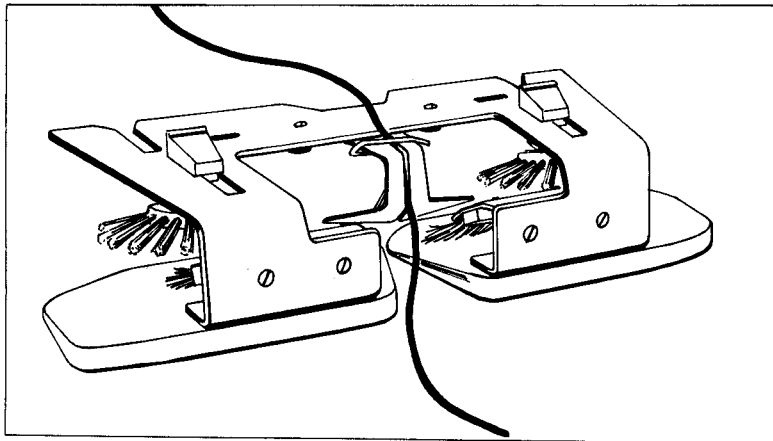

N.B. Always move the carriage across until you hear the click at the end of a row.
You will now have a loop around each needle and under each peg of the comb.

40

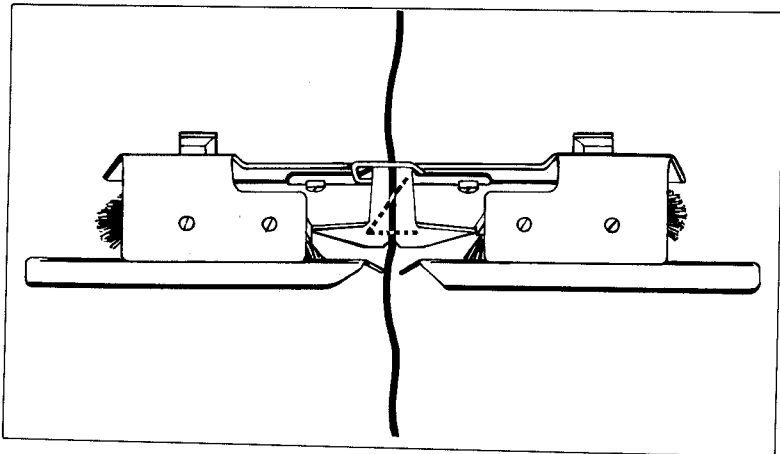

(N.B. If a few end needles have been pulled forward from Position B then simply push them back by hand before continuing).

(6) You can now lower the cast on comb by turning the end pegs (at the **same** time) towards you. This will release the comb from the gate pegs and you can allow it to drop, slowly. (See Figs. 41 & 42).

Note: The cast-on loops are still loose so take care not to turn the comb out of a vertical position or the loops may fall off.

(7) Raise the thread from the comb to the carriage, so that it goes under the last comb peg, adjacent to the end needle and above the rest.

(8) Knit the next row slowly and continue knitting. The cast on comb can be removed after the first 6 or 8 rows by tilting it backwards. After a few rows, remove the knitting from the machine (i.e., taking the thread out of the yarn feeder and knitting one row across). Practice this cast on two or three times. See Fig. 43).

YOU ARE NOW ABLE TO DO A QUICK OPEN END CAST ON. THIS METHOD IS NOT USED WHEN PRODUCING GARMENTS – BUT IS USEFUL FOR KNITTING SWATCH SAMPLES AND EXPERIMENTING.

ALTERNATE METHODS OF CASTING ON ARE GIVEN FURTHER ON.

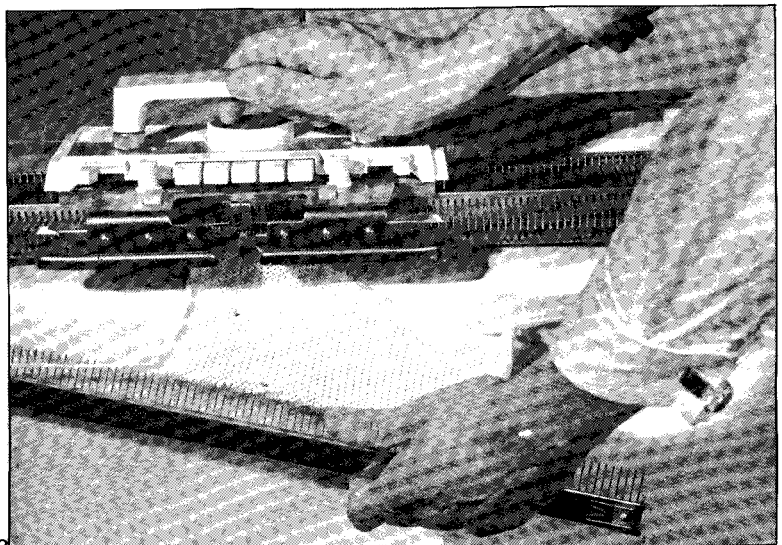
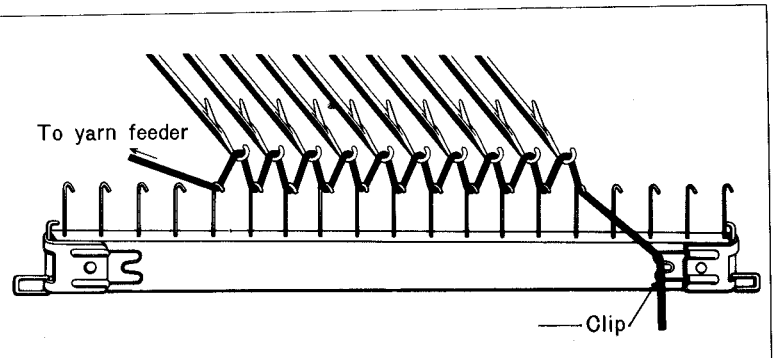
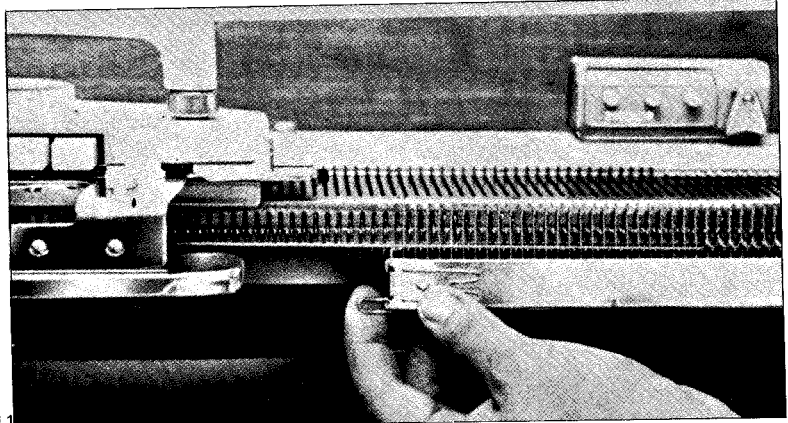

The purl side (or wrong side) of the knitted fabric (facing you) looks like this. (See Fig. 44).

The plain side (right side) of the fabric (away from you) will look like this. (See Fig. 45).

IF THE CARRIAGE SHOULD JAM AND HOW TO UNRAVEL A ROW

(See Fig. 46).

(1) Loosen the thumb screws of the sinker plate and remove the sinker plate from the carriage.

(2) Holding the handle tilt the carriage backwards and slide it back to the side from where that row commenced. When it is clear of the end needles in action lower the front again onto the needle bed.

(3) With the yarn still in the yarn feeder, return the sinker plate to the carriage and tighten the thumb nuts securely.

(4) Unravel the last row of knitting (see below).

UNRAVELLING A ROW OF KNITTING

(1) Pull the yarn slightly sideways and up. (See Fig. 48). The stitches will come off the needles and the stitches from the row below will slip onto the needles.

(2) Continue to pull the yarn sideways and up removing 4 or 5 stitches at a time until you reach the spot where the carriage was jammed.

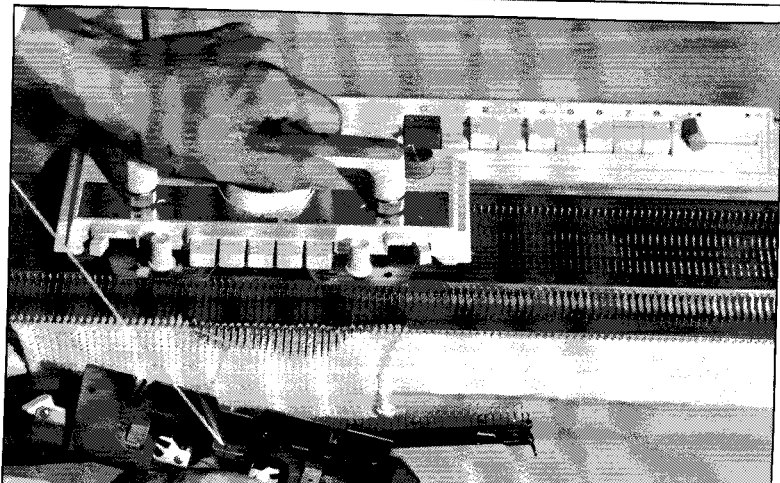
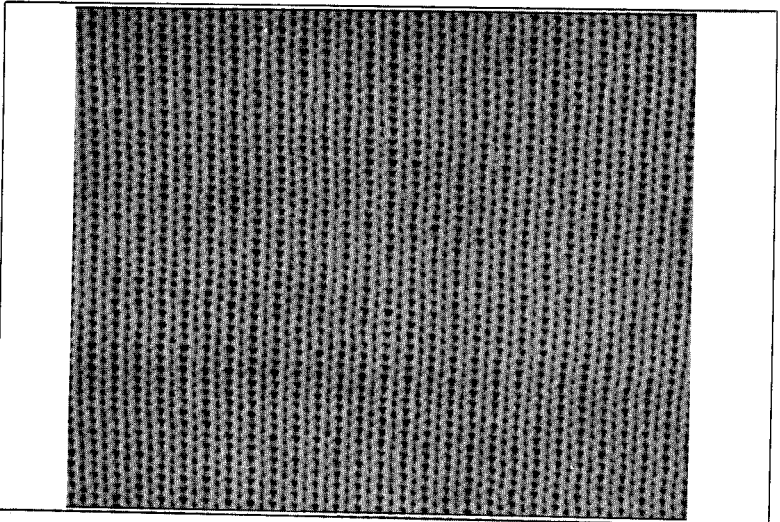
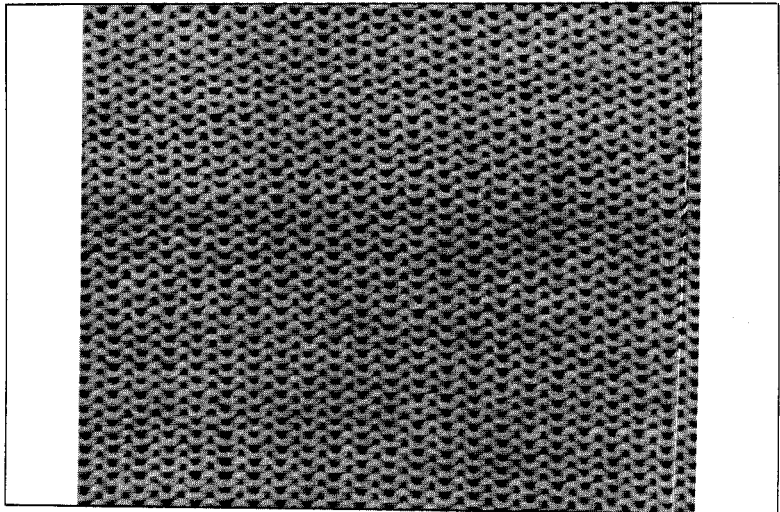

(3) Pull the yarn down from the rear (above ball) to take up the slack and to bring the take of spring back into action.

(4) Ensure that there is no slack from the carriage to the needles by sliding the carriage left and right a few inches (NOT ACROSS NEEDLES IN ACTION). (See Fig. 49).

(5) ADJUST THE NUMBERS ON YOUR ROW COUNTER.

IF YOU FIND IT NECESSARY TO MOVE THE CARRIAGE ACROSS THE NEEDLES IN ACTION WITHOUT KNITTING A ROW – Then press both PART buttons in at the same time and set both H.C.L's to 111. If any needles have been selected then pull them back to B position before going across with the carriage.

BEFORE CONTINUING: LET'S LOOK HOW A STITCH IS FORMED.

- (1) The stitch is on the needle which is behind the gate pegs.
- (2) The carriage brings the needle forward by pushing the needle butt.
- (3) The stitch pushes the latch back and falls behind it.
- (4) The new thread (from the yarn feeder on the carriage) is laid into the needle hook.
- (5) The carriage brings the needle back and so doing the previous stitch gets pushed forward again – this time right over the latch (by-passing the hook).
- (6) The newly laid thread gets pulled in to form another stitch,

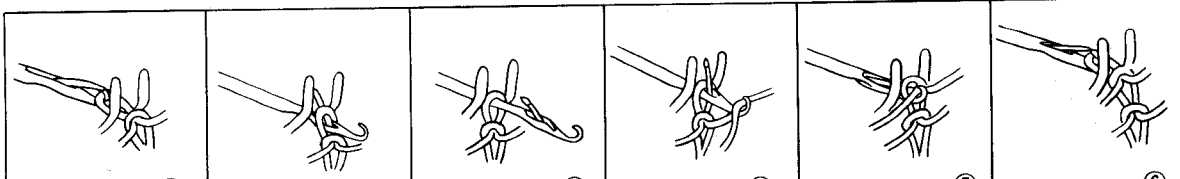
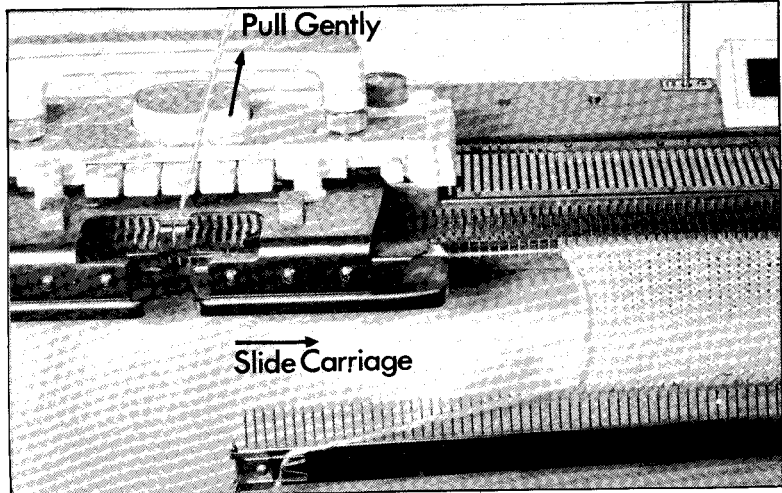
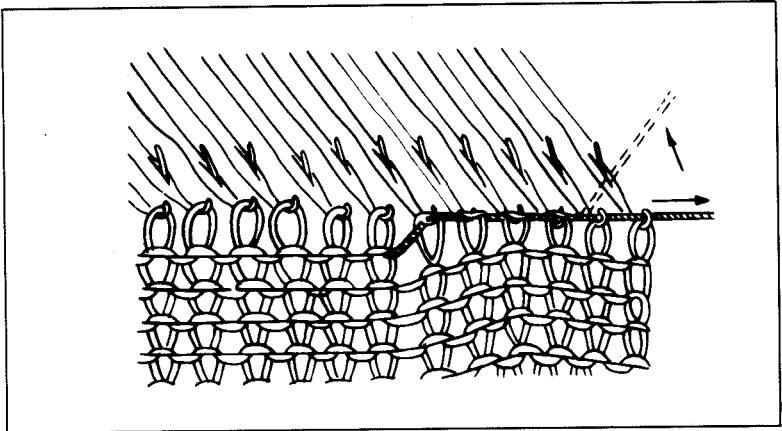
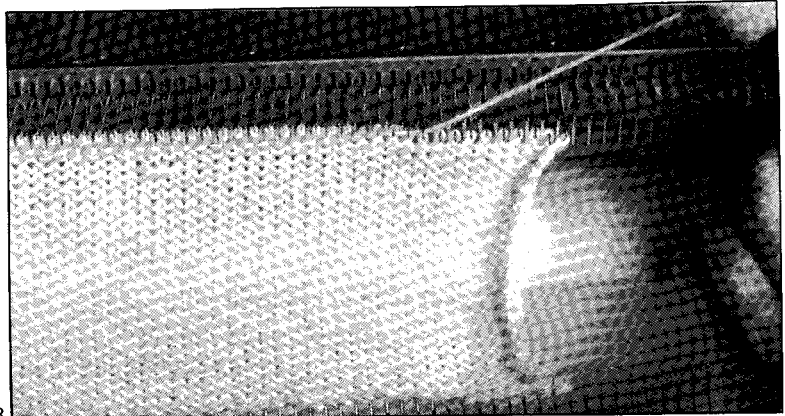

Now lets knit a plain hem

20

Bring forward the required number of needles (evenly divided on either side of the centre 'O') to working position B. Slide the carriage across these needles to straighten the needle butts.

CARRIAGE SETTING

Centre Button – Plain.
H.C.L's – Both on I.
Change knob N.
Tension Dial – 7 (3-ply wool).
Carriage on the right.

MACHINE SETTING

Slide Dial – 1.
Reverse Lever – +.

Thread the yarn tension unit using waste wool (or any contrast colour yarn). Cast on (as previously shown using the cast on comb) and knit 8 or 10 rows plain. Remove the cast on comb from the knitting.

- (1) Tighten the tension by two numbers lower (i.e., 5).
- (2) Thread the waste wool below the yarn feeder and re-thread the machine with the wool to be used.
- (3) Set row centre back to 'O'.
- (4) When the yarn is threaded into the carriage hold it below with one hand and knit across with the other.
- (5) Knit approx. 20 or 30 rows or as required for double the depth of hem.
- (6) Using the single eyed transfer tool open the latches of the needles as shown (refers to photo 50).

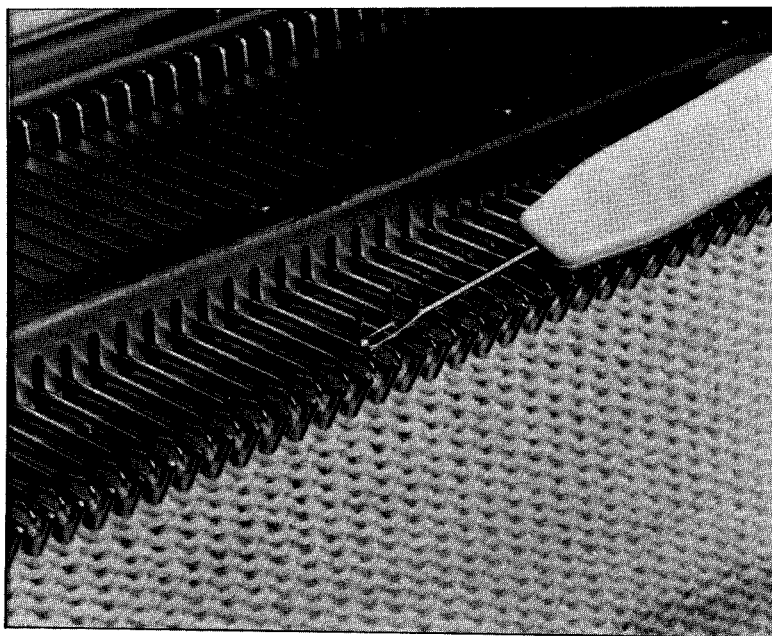

TURNING THE HEM

Pick up the first stitch (away from carriage) of the first row where it meets the contrast colour row. (N.B. DO NOT PICK UP THE CONTRAST COLOUR STITCH). Insert the transfer tool into this stitch and lay the tool over the hook of the needle.

(2) Hold the work forward with your left hand and pull the transfer tool back and up with your right. This brings the needle forward to E Position and slips the stitch from the tool onto the needle. (N.B. If you intend to do the next row in a pattern stitch that required the needles to be in B Position – then do not pull the transfer tool back, but simply raise it upwards so that the stitch falls onto the needle. **Make sure that the needle does not come forward enough for the two stitches to fall behind the latch**).

(3) Continue raising the first row of stitches in this manner until all the needles have two stitches on them.

(4) Reset the tension dial to 7 and take up any slack in the wool from the knitting to the carriage.

(5) Continue knitting the garment.

REMOVING THE WASTE WOOL

Once the garment has progressed a few inches you can remove the waste wool by breaking the end stitch of the row joining the knitting and pulling the loose thread at the other end of this row.

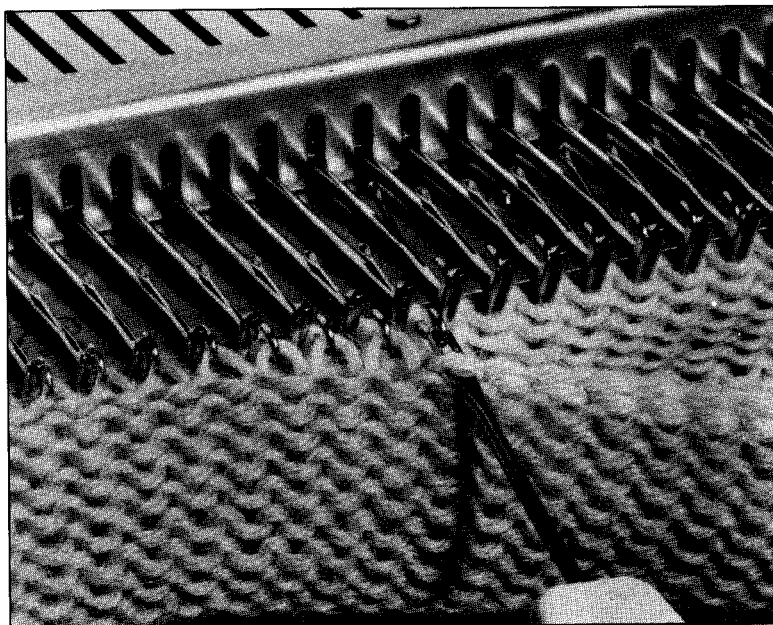

Now lets try an elastic hem (i.e. continental or double 'rib')

22

Bring forward the required number of needles to B Position. Carriage and machine settings as for 'PLAIN HEM'. Press the pattern selector buttons Nos. 1, 3, 5 and 7 and swivel the set lever to the left. This will bring every alternate needle forward. Using the flat side of a needle pusher – push back the other needles all the way (Position A). Press the release button (blue) on the Pattern Selector Unit and move the carriage across and back to align all the alternate needles in Position B.

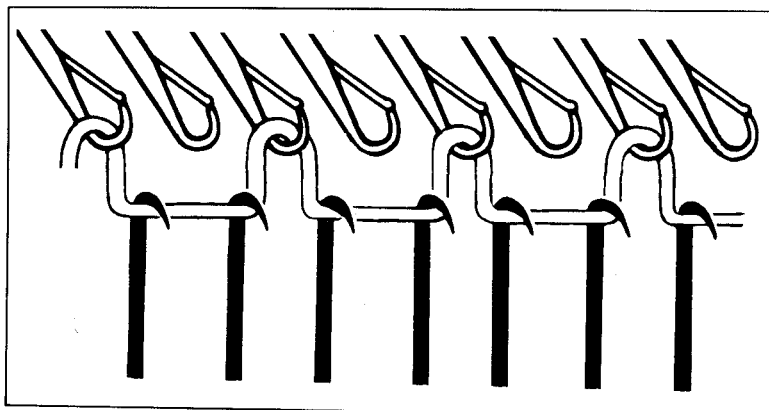

(NOTE: IF YOU FIND THIS METHOD DIFFICULT THEN SIMPLY BRING FORWARD EVERY ALTERNATE NEEDLE TO B POSITION, BY HAND).

(1) Thread up and cast on with waste wool as before. (When the comb is dropped it should catch the first row as illustrated in No. 52).

(2) After knitting 8 or 10 rows of waste wool break the wool and re-thread with the wool to be used. Lower the tension to 2.

(3) Knit approx. 40 or 50 rows. (See Figs. 53 and 54).

(4) Bring forward all the empty needles from Position A to Position B, by hand and make sure that all the latches are open.

(5) Using the one eyed transfer tool and starting from the end opposite the carriage pick up each stitch from the first row (where it joins the waste wool) and raise these onto the empty needles. (See Fig. 55).

(NOTE: As explained under 'plain hem' when raising these stitches the needles can be brought forward to E Position to ensure that the stitches do not drop off – or they can be left in B Position).

(6) Return the Tension dial to 7 and after knitting a few inches the waste wool can be removed.

52

53

54

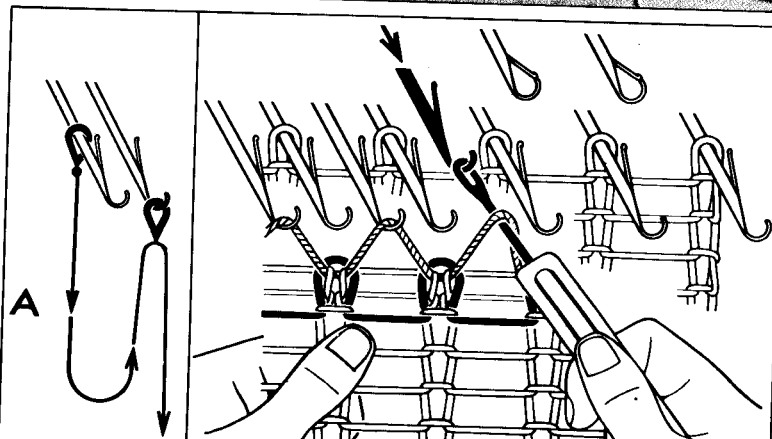
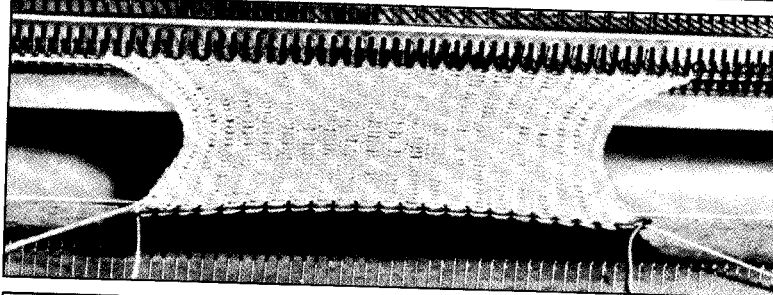
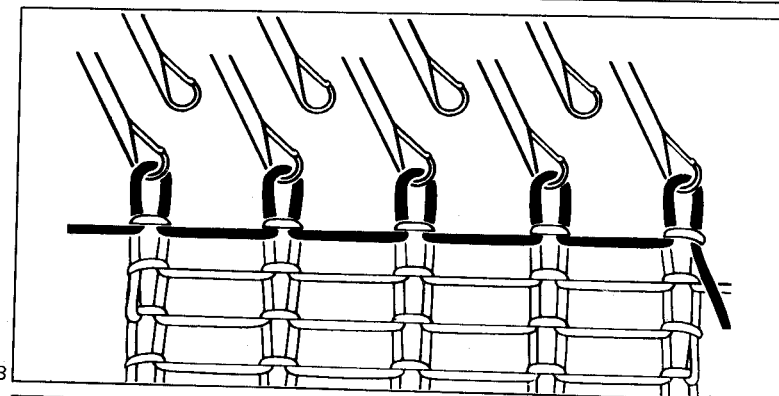

**THE FINISHED
"DOUBLE RIB"
SHOULD LOOK LIKE
THIS**

(See Fig. 56).
MANY variations of this elastic rib can be made for cuffs and hems. One of the more popular is the 2 x 1 Double Hem – the instructions of which are given here.

(1) Bring forward the required number of needles to B Position – and using the 2 x 1 needle pusher – push back every third needle to Position A (out of action). (See Fig. 57).

(2) Follow the previous instructions for the 'continental rib', but when raising the first row of stitches (adjoining the waste wool) – put them onto the adjacent two needles to the left (See Fig. 58).

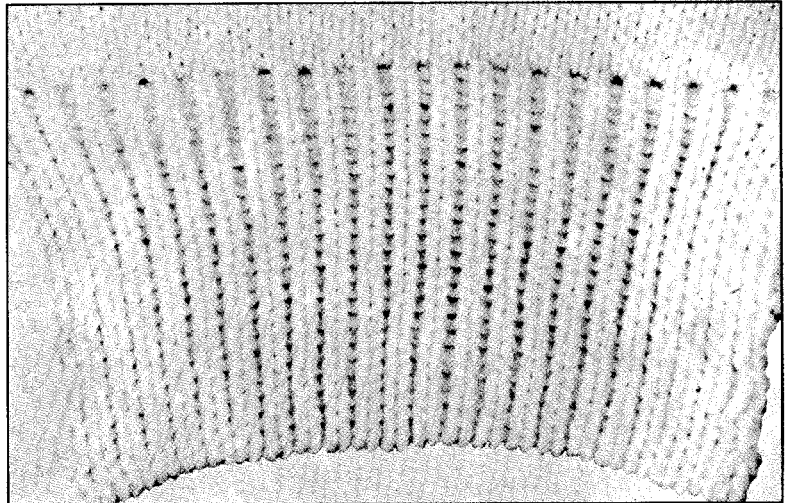

56

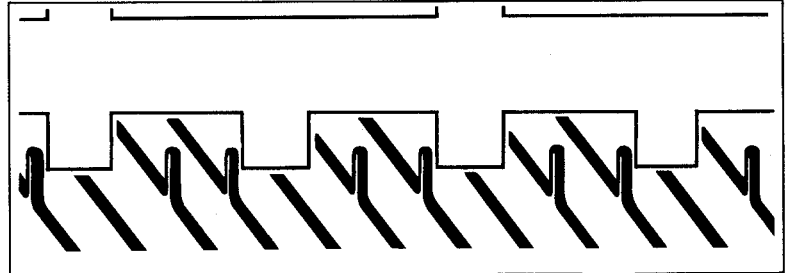

57

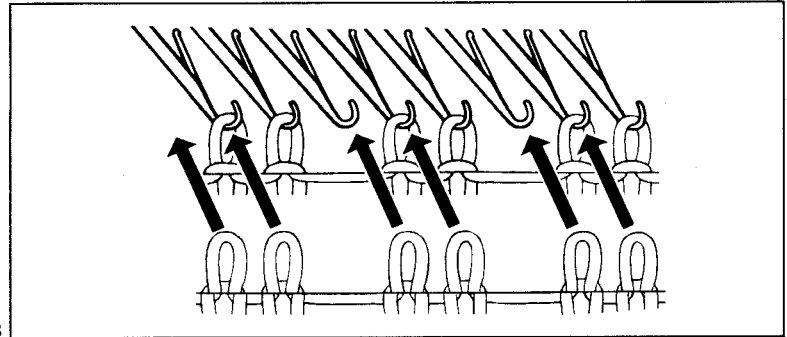

58

**THE COMPLETED
2 x 1 RIB WILL LOOK
LIKE THIS**

(refers to 59)
So far you have learned to cast on with a double hem – now let's see some other methods of casting-on.

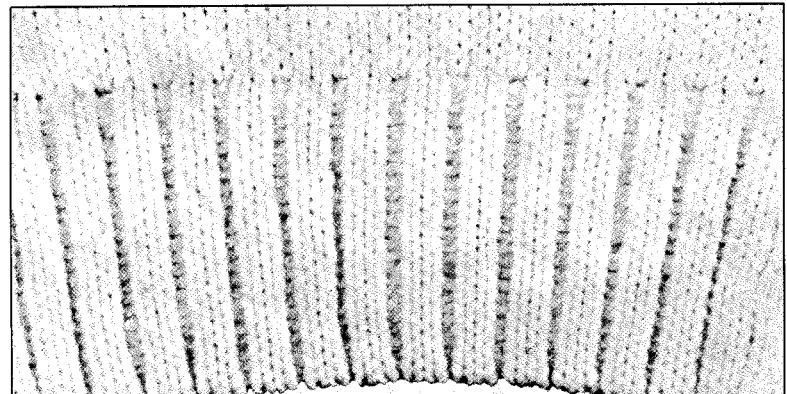

Automatic cast-on

Finished edge cast-on (hand method)

24

Automatic Cast on 580, 585 & 588 ONLY CARRIAGE SETTING

H.C.L.'s – both on I.
Change knob – on N.
Weaving Knobs – on N.
Tension Dial – 5 (for 3-ply yarn).
Carriage button – both PART in.

MACHINE SETTING

Reverse Lever – on +.
Slide Dial – on I.
P.S. Buttons – Press 1, 3, 5 and 7.

Bring forward the required needles to B Position and press the Pattern Selector Button 1, 3, 5 and 7. Swivel the set lever to bring out the needles.

(1) Thread the yarn into the carriage and knit one row (loops will form on needles).

(2) Turn the reverse lever to – and knit one row. Hold the end of the yarn loosely with one hand.

(3) Turn the reverse dial back to + and knit one row.

(4) Turn the reverse lever to – and knit one row.

(5) Press the centre carriage button 'PLAIN' and push both weaving knobs to T.

(6) Knit the next two rows slowly – and continue knitting. This edge is not the neatest you can produce; and we do not recommend this method if it is to be on view. However, if it is to be folded in, or simply used for sample swatches, then it is the quickest sealed edge cast-on possible.

needle from left to right, counter clockwise. The loops must be pushed back on the stems of the needles. To control these loops as you wind, hold your thumb under the last one before making another. Do not make the loops too tight. (See Fig. 60). (4) Now thread the yarn into the feeder, and pull the strand

(coming from the ball) down, to take up any slack.

(5) Gently move the carriage to the left to knit the first row.

(6) Lower the comb onto the stitches and see that the yarn goes above the comb pegs that are not opposite needles in action. Leave the comb suspended until about 10 rows have been completed.

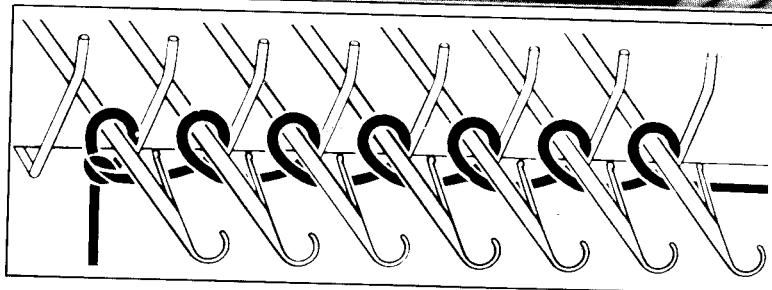
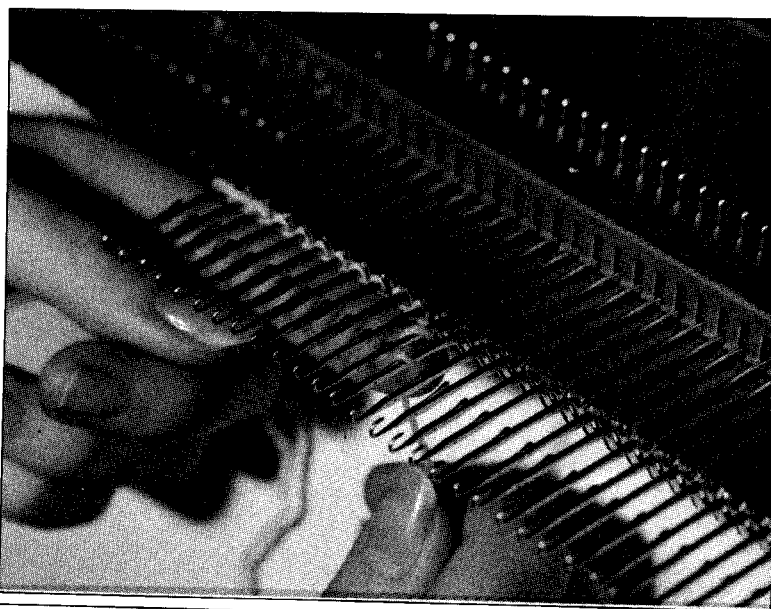

Finished Edge Cast on Hand Method

Place the carriage on the right and set the Tension Dial to 5. Hang the cast on comb onto the pegs of the needle gate.

(1) Bring forward to Position E, all the needles required.

(2) Fasten the end of the yarn (threaded only through the yarn tension unit) onto the end needle on the left, using a slip knot.

(3) Loop the yarn around each

Knitting a picot hem

Picking up dropped stitches

Picot Hem

Set the machine as for the 'PLAIN HEM' and knit up to half the depth of the hem with the Tension Dial two numbers lower than required for that wool - 5 (i.e., If the hem is to be 50 rows then knit up to the end of the 25th row, starting from where the main wool joins the contrast colour).

FOR MODELS WITHOUT LACE CARRIAGE

Using a single eyed transfer tool open the latches of all the needles in action. Starting from the second end needle place the transfer tool onto the hook and pull the tool and needle towards you. (See Figs. 65 to 68) Now push it back so that the stitch slips off the needle and onto the tool.

Transfer the stitch to the adjacent needle by placing the eye over the hook of the first needle and tilting the tool upwards. The stitch should fall off the tool and onto the needle. Continue transferring every second stitch onto the previous needle until you have two stitches on every alternate needle.

FOR MODELS 585 & 588 ONLY

Place the Lacy Carriage (See section on lacy knitting) onto the needle bed. Push down P.S. Buttons 1, 3, 5 and 7 and set the lever. If an end needle (away from carriage) is set then post it back to Position B by hand. Slide the lacy carriage across the needles in one movement. (This will transfer every second stitch to the adjacent needle - automatically).

FOR ALL MODELS

Reset the Tension Dial to 7 and take up any slack in the yarn from the carriage to the

Bring all the empty needles into a straight line together with the others in Position B. Knit the other half of the hem (i.e., 25 rows) and raise the first row of stitches as for the 'PLAIN HEM'.

Dropped Stitches

A. IF THE STITCH HAS DROPPED ONE ROW, then with the single transfer tool pick up the stitch and the unknitted thread and put them both on the empty needle. Push the needle forward, until the stitch falls just behind the latch of the needle; catch the thread of the unknitted stitch into the hook of the needle, and push the needle back. The stitch will slide over the closed hook of the needle and be re-knitted.

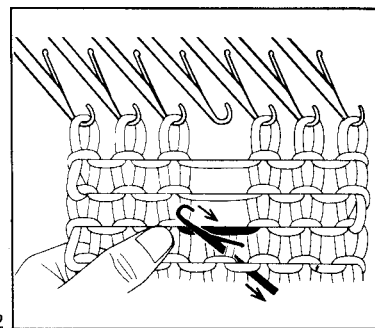
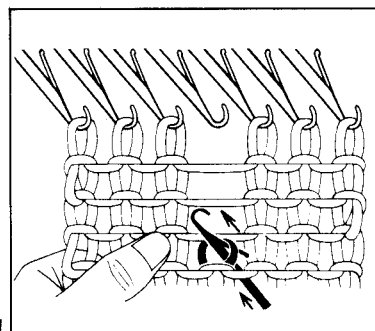

B. IF THE STITCH HAS DROPPED A NUMBER OF ROWS, then insert the latch hook into the last stitch that has not dropped, from behind the fabric (i.e., the side that is not facing you).

- (1) Hold the latch hook at right angles to the knitting, and pull the knitting down slightly.
2. Push the tool towards you. The stitch will fall behind the latch. (See Fig. 61).
- (3) Now pull the tool back, at the same time catching the thread across in the hook. Make sure to position the hook in the centre of the horizontal thread, and to pull, the tool all the way back until the stitch is formed. (See Fig. 62).
4. In the same way knit the stitches all the way to the top stitch.
- (5) Place the transfer tool (or a crochet hook) into the hook of the latch tool, and transfer the last stitch onto the transfer tool. Now place the stitch onto the empty needle. (See Fig. 64).

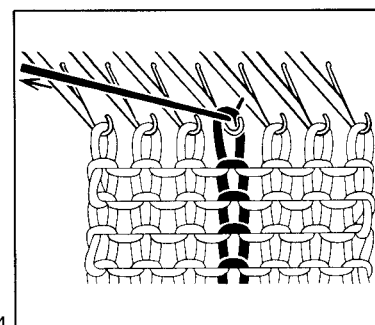
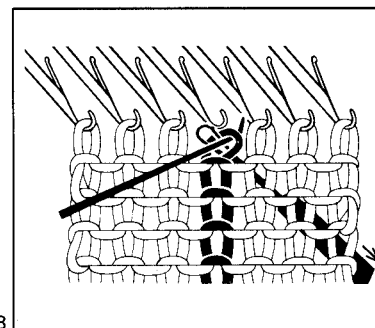

How to use the transfer tool

26

The transfer tools are used to move stitches onto different needles to effect the shaping of the garment, and also to form lacy patterns. Before transferring the stitches you should open the latches of the needles to be used.

(1) Hold the one eyed transfer tool parallel with the needles. Place the eye into the hook of the needle. (See Fig. 65).

(2) With the transfer tool, bring the needle forward. The stitch in the hook of the needle will slide behind the latch and onto the stem of the needle. (See Fig. 66).

(3) Without releasing the transfer tool, push the needle all the way back until the stitch is transferred onto the transfer tool (See Fig. 67).

(4) Raise the transfer tool with the stitch on it and transfer it to the adjacent needle, right or left as desired. (See Fig. 68).

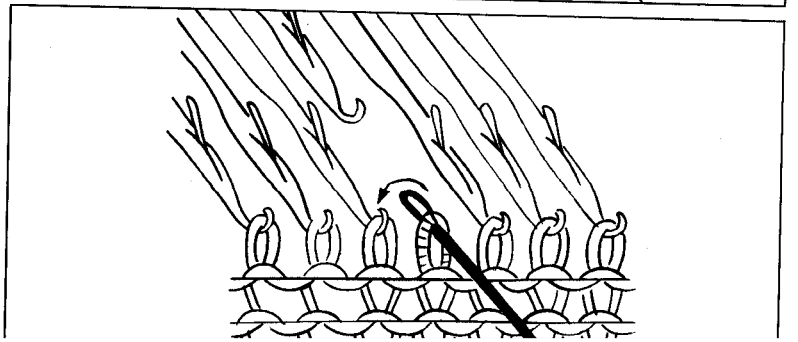
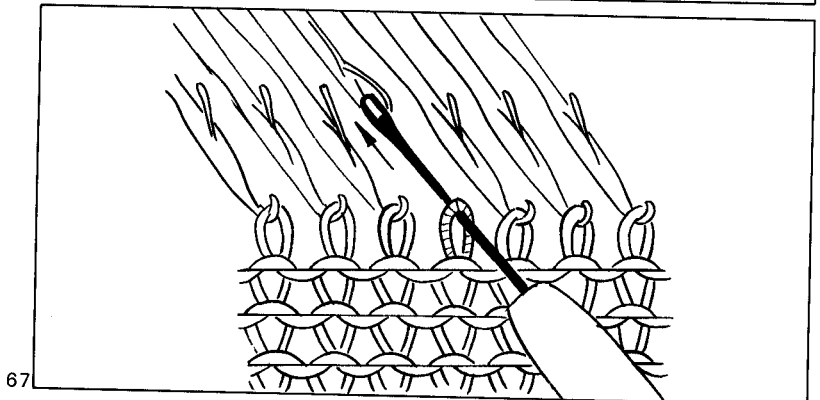
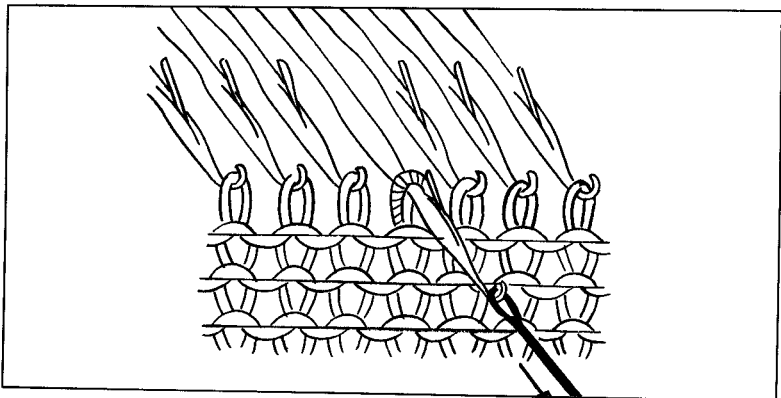
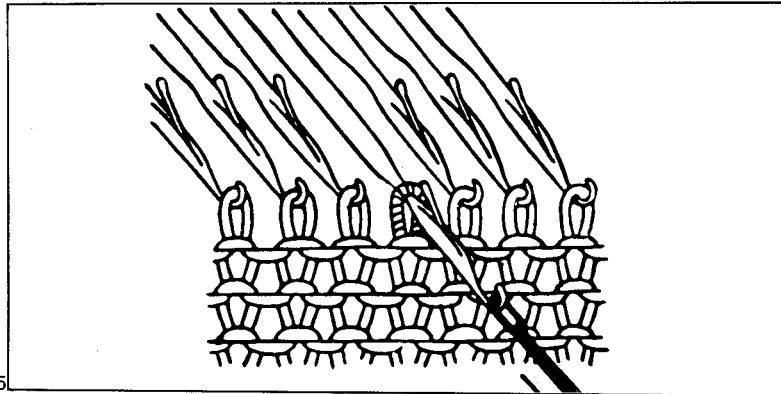

ONE STITCH AT EITHER EDGE

A. SIMPLE METHOD. Simply bring into working position B one needle from Position A, on the side nearest the carriage. The empty needle will pick up the yarn on the next row.

B. FULL FASHIONED METHOD. (1) Using the two needle transfer tool, move the stitches out by one needle so that the third needle from the end becomes empty.

(2) To fill in the empty needle pick up the purl side of either adjacent stitch on the lower row. (See Fig. 70).

SEVERAL STITCHES AT EITHER EDGE

(1) Push the needles to be increased, to Position E on the same side as the carriage.

(2) Loosely wind the yarn around the stems of each needle, going around the needles from below.

(3) Raise the H.C.L.'s to Position 1.

(4) Knit across one row. To ensure perfect knitting on the increased stitches, raise these needles to Position E before knitting across for the next 2 or 3 rows.

INCREASING ONE STITCH IN THE CENTRE ROW

(1) Determine the position where you want to increase one stitch.

2. Use the 3 needle transfer tool, starting from either end, transfer all the stitches outward in either direction until the required needle is free. (See Fig. 72).

3. Pick up the adjacent lower half stitch onto the empty needle. (See Fig. 73).

INCREASING SEVERAL STITCHES IN THE ROW

The afore mentioned method can be used working from the centre outwards, or you can transfer the knitting from the knitter to a knitting needle and then return the stitches. Before the knitting is transferred back from the knitting needles to the knitter, determine the number of stitches to be increased and space the replaced stitches so that there will be an equal number of stitches transferred between each extra needle (leaving empty needles where extra stitches are required). Raise the neighbouring lower half stitches to the empty needles. (See Fig. 73).

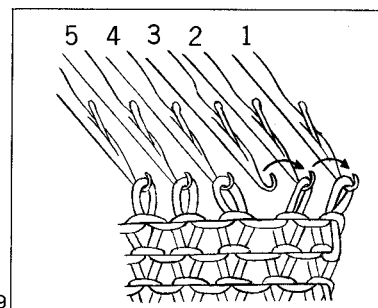

69

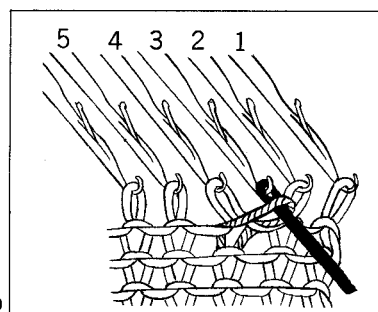

70

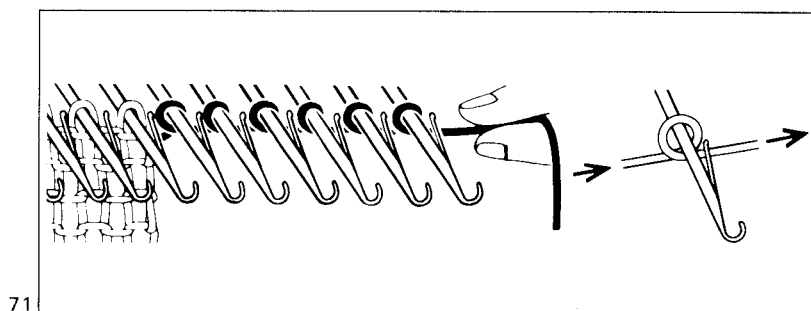

71

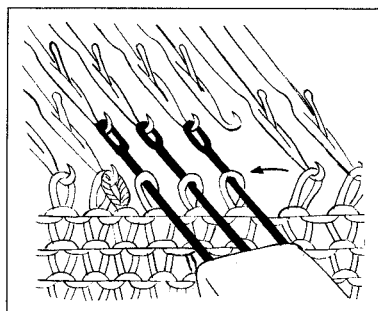

72

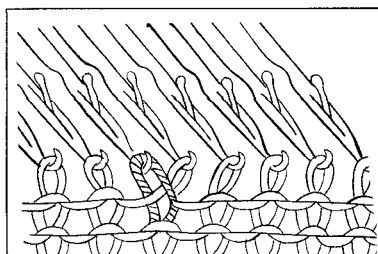

Transferring to hand knitting needles

28

- (1) Slide a hand knitting needle into the first stitch from behind the knitting. With your left hand hold the knitting close to the knitter. With your finger, bring the needle forward so that the stitch in the hook of the needle slides onto the stem of the needle, behind the latch.
- (2) Push the needle all the way back so that the stitch slips all over the closed hook of the needle onto the knitting needle.
- (3) Slide the knitting needle into the next stitch and repeat until all the stitches are off the needles on the needle bed.

74

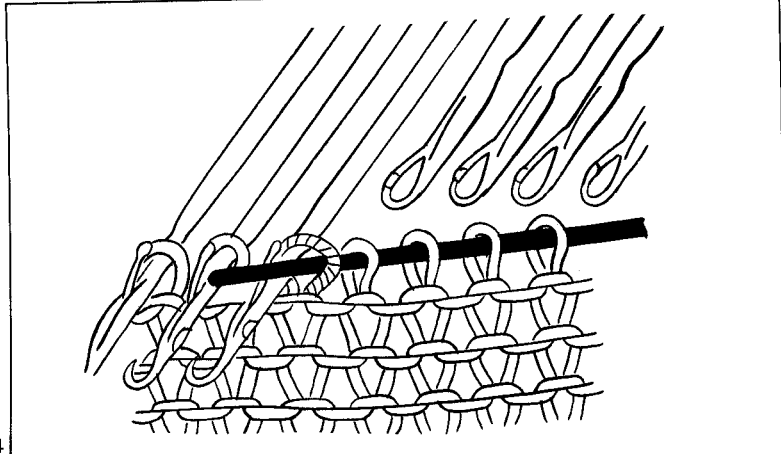

TRANSFERRING OFF THE HAND KNITTING NEEDLE ONTO THE KNITTER

A. USING THE TRANSFER TOOL

- (1) Open the needle latches.
- (2) Hold the fabric in your left hand with the desired side facing you, the hand knitting needle being in line with the needles.
- (3) Pass the transfer tool through the stitch on the knitting needle from the front. (See Fig. 75).
- (4) Transfer the stitch from the transfer tool onto the hook of machine needles. Push the needles with the transferred stitches back as far as they will go.

75

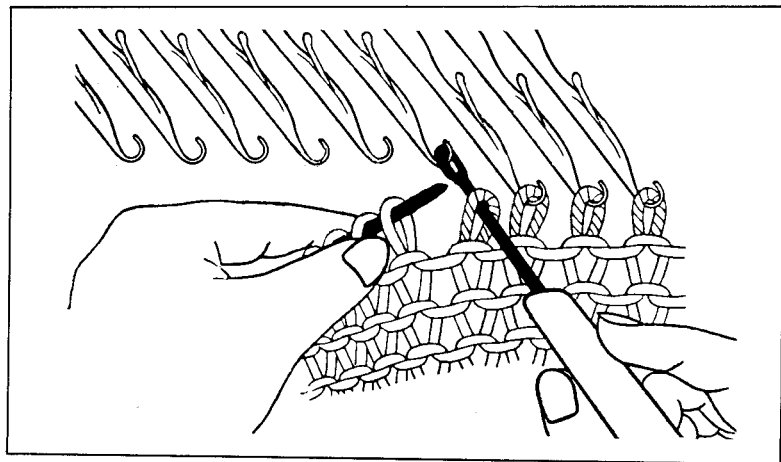

B. ALTERNATE METHOD

- (1) Bring the needles forward to Position 'D', and open the latches.
2. Begin from the left side.
- (3) Transfer the stitches from the hand knitting needle onto the open hooks of the machine needles. (See Fig. 76).

76

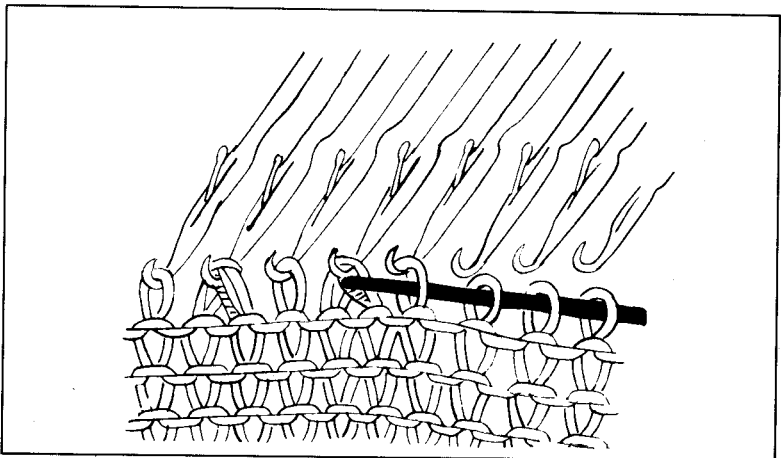

Decreasing stitches

ONE STITCH AT EITHER EDGE

A. SIMPLE METHOD.

Using the single transfer tool, transfer the end stitch onto the second needle (See Fig. 77) and push empty needle back to Position 'A'.

B. FULLY FASHIONED DECREASING.

With the single needle transfer tool, transfer the end stitch to the second needle and the 2nd stitch to the 3rd needle, together. Push the empty needle out of action.

77

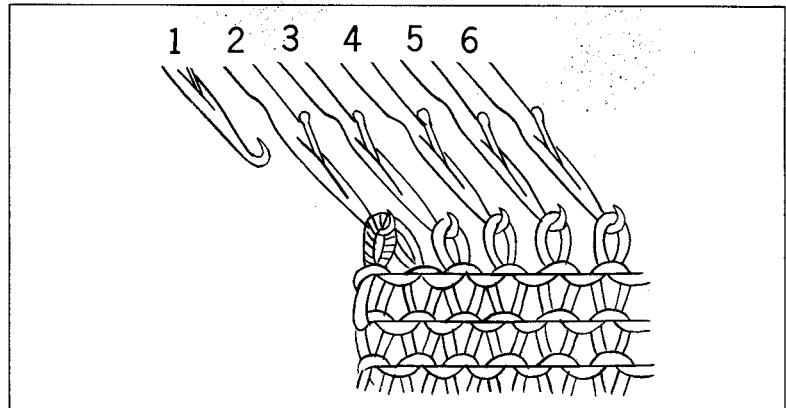

DECREASING ONE STITCH IN THE CENTRE OF ROW

(1) Use the single transfer tool and transfer a centre stitch to adjacent needle. (See Fig. 78).

(2) Using the 3 needle transfer tool, shift all stitches in until all needles 'in action' have stitches on them, and place the outer empty needles out of action. (See Fig. 79).

78

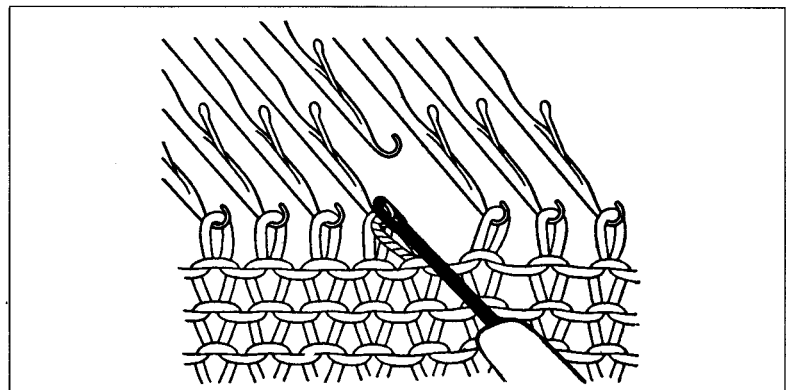

DECREASING SEVERAL STITCHES IN A ROW

(1) Transfer the knitting to a hand knitting needle: (See Fig. 74).

(2) Before returning the knitting from the knitting needle back to the knitter, calculate the proportional reduction in the number of stitches.

For example, to decrease one stitch in every three, hang the 2nd and 3rd stitches both onto one needle. (See Fig. 80).

(3) The number of needles with double stitches represents the number of stitches decreased.

79

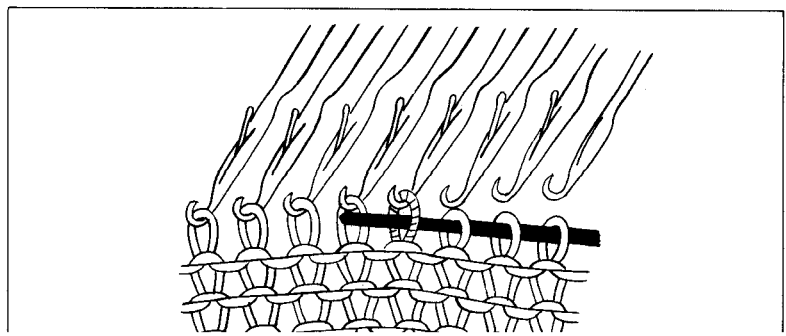
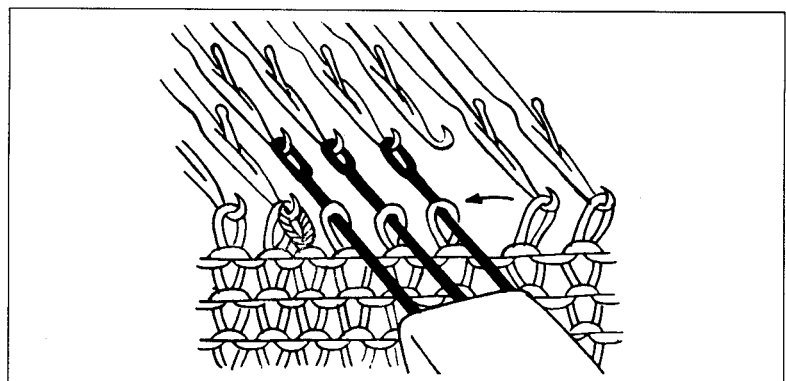

Casting-off

30

METHOD A

(1) On the same side as the carriage, transfer the end stitch to the 2nd needle. (See Fig. 81).

(2) Bring forward the needle with the two stitches so that the stitches fall behind the needle latch. (See Fig. 82).

(3) Place the yarn in the needle hook, in front of the latch and push the needle back manually to form a single stitch. (See Fig. 83).

(4) Repeat this process for each stitch. Take care not to make the stitches too tight.

After practicing this, you may find it easier to transfer the stitch you have formed by hand, without using the transfer tool.

This method can be used for binding off any number of stitches at neck, armhole, shoulder or pocket edges.

(1) Knit the last row on a much looser tension than the rest of the garment.

(2) Start on the side opposite the carriage.

(3) Hold the latch tool upright, so latch remains open.

(4) Insert the latch hook into the first 2 stitches and remove them from the needles. Let the first stitch slide past the latch.

(4) Pull the second stitch through the first – this leaves one loop in the hook of your latch tool. Continue to bind off one stitch at a time, and seal the last stitch with a slip knot. (See Figs. 85 and 86).

No mention is made in these instructions of decreasing at the centre of the neck or of shaping at the armholes. Whilst following the steps below, the decreasing and shaping must be carried out according to the instructions in the knitting pattern, or according to the measurements of the garment.

Remember to put all empty needles back to Position 'A' after transferring and before continuing to knit.

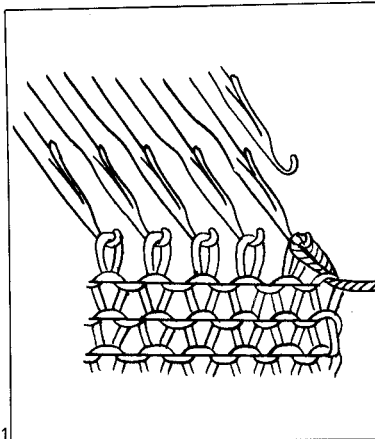

81

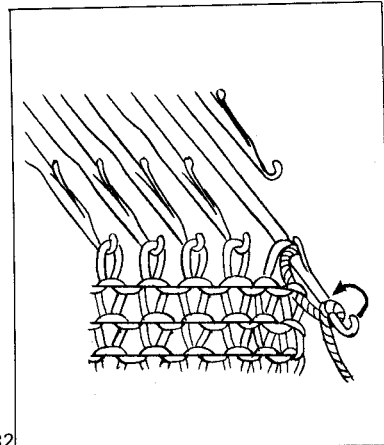

82

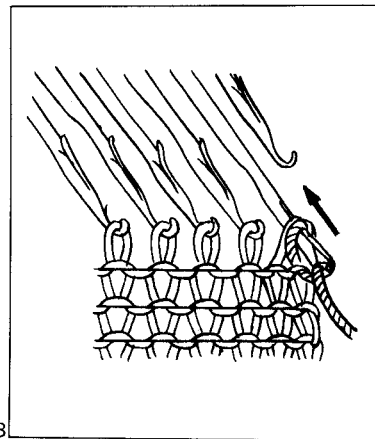

83

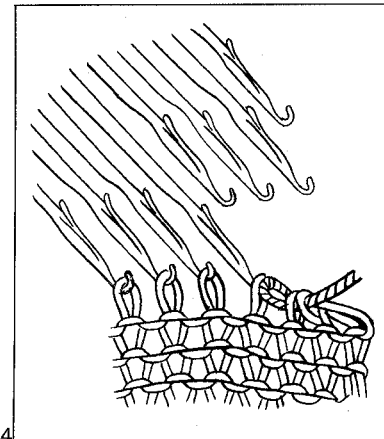

84

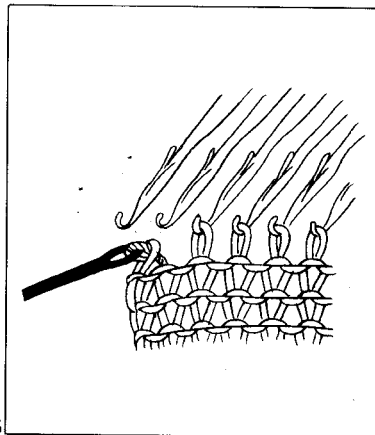

85

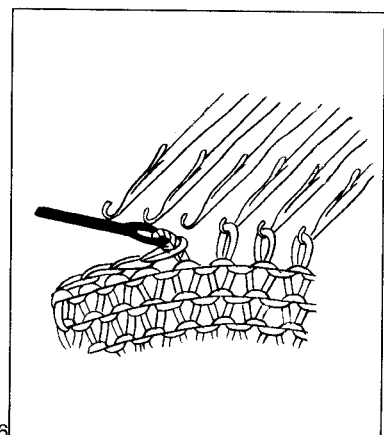

86

Button-holes small

Button-holes medium

Small

- (1) Open the latches of two needles where the buttonhole is to be.
- (2) Using the one eyed transfer tool, move the stitches on the right over to the left.
- (3) Bring back the butt of the empty needle to Position B, and continue to knit.

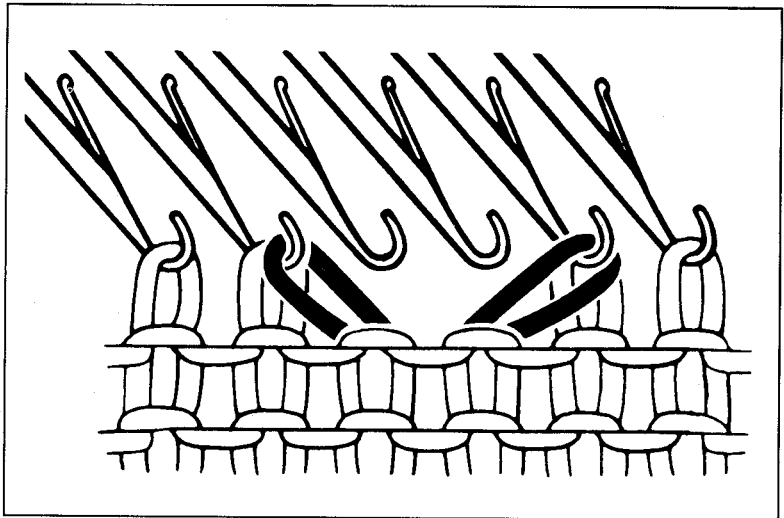

87

Medium

- (1) OPEN THE LATCHES OF A GROUP OF FOUR NEEDLES.

- (2) Transfer the inner two stitches to the adjacent outer needles (See Fig. 87).
- (3) Return the two empty needles to Position B and knit one row (See Fig. 88).

- (4) After this row the two centre needles will only have loops (See Fig. 89).
To ensure that these needles knit on the next few rows, bring them both forward to Position E (for next 2 rows), making sure that the loops fall behind the latches.

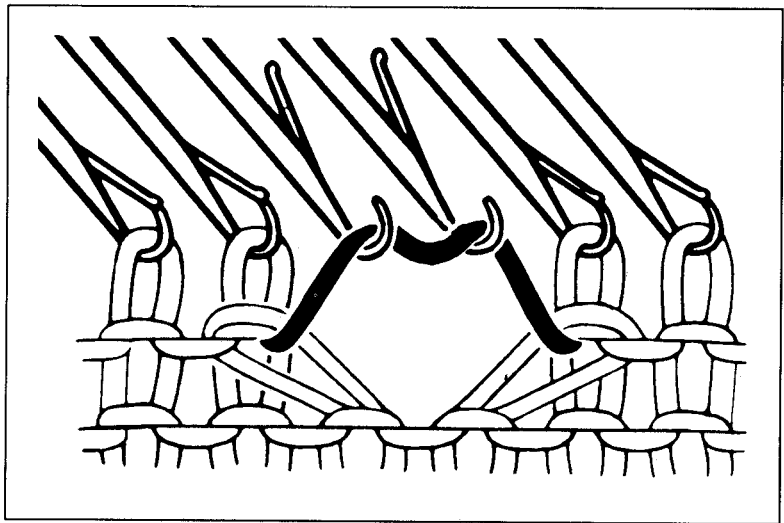

88

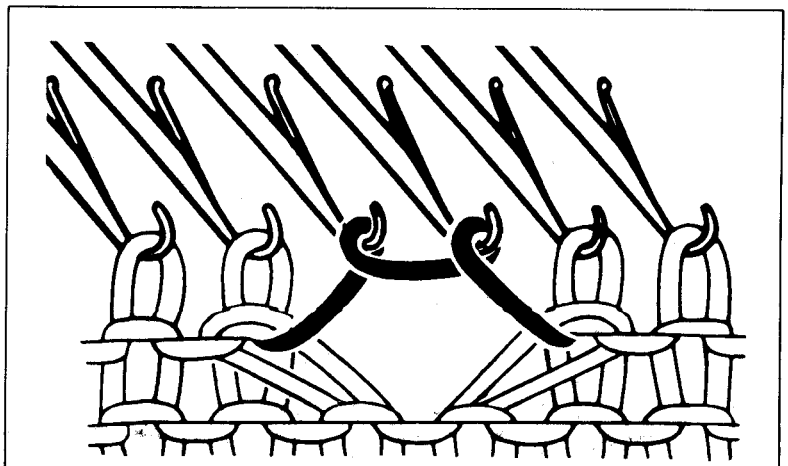

Button-holes Large

32

(1) Determine the position of the buttonhole. Purl the stitch adjacent to where you want the buttonhole to start.

(2) Catch the purled half stitch and bring it forward onto the latch hook (See Fig. 90). With this as your first stitch, crochet through the next adjacent stitches of the buttonhole – thus casting off (See Fig. 91).

(3) Transfer the stitch off the latch hook, on to the next adjacent needle (See Fig. 91).

(4) Knit one row (H.C.L.'s. on I).⁹⁰ The wool will loop over the empty needles (See Fig. 92).

(5) Starting from the end where the bottom part was sealed off – wind the wool around each needle individually. If there is any left over (this will depend on the tension you are using) then wind an extra loop around each adjacent needle (See Fig. 93). Do not wind too tight.

(6) Raise the needles with the wound loops and a few adjacent needles on either side to Position E. Make sure the loops fall behind the latches. Continue to raise these needles (if it does not interfere with the pattern) for the next two or three rows of knitting.

ALTERNATIVE METHOD FOR LARGE BUTTON-HOLES

Using a contrast colour wool, cast off the number of stitches needed for the buttonhole. Continue knitting (raising these⁹² needles to Position E for the next few rows) until the garment is completed. The buttonhole can be finished by stitching, and the contrast wool taken out.

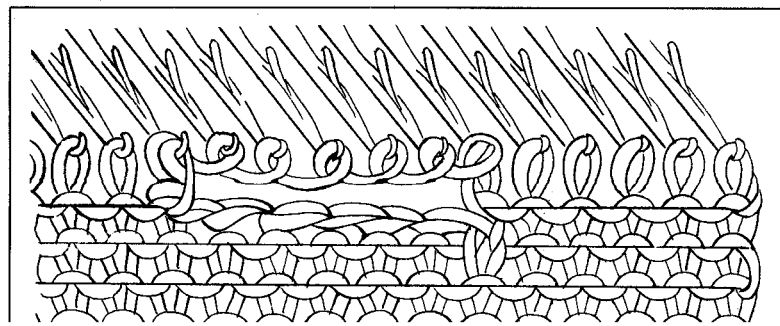
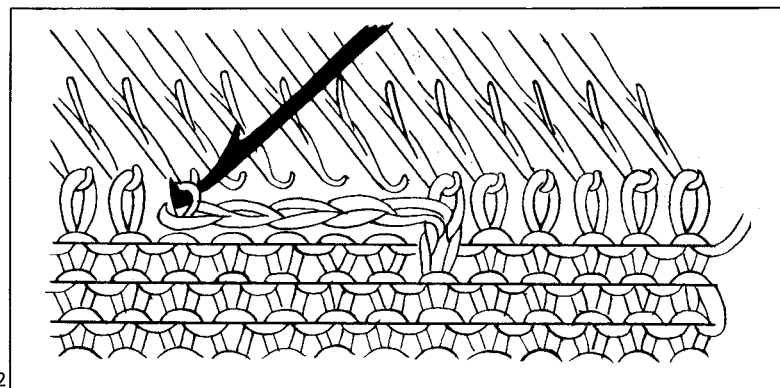
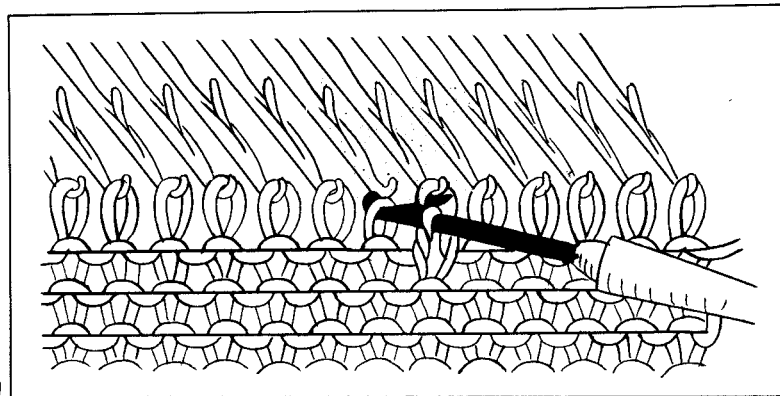
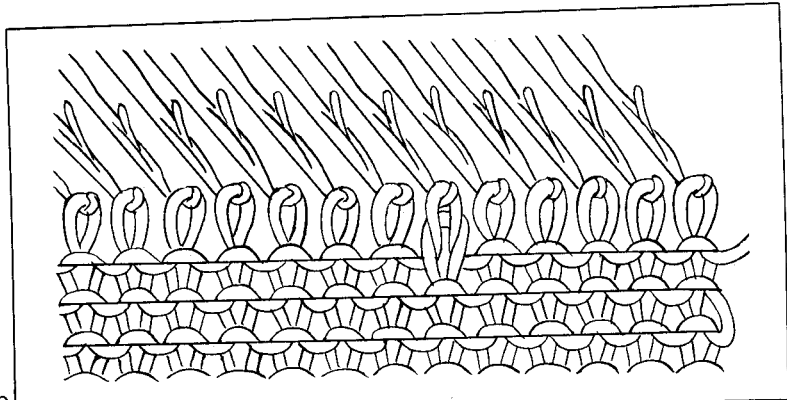

Making a vertical buttonhole

How to knit a pocket

Making a Vertical Button Hole

Knit up to the row where the buttonhole starts. If the carriage is on the right side of the needle bed, knit the right side of the buttonhole first.

(1) Set both H.C.L.'s to Position III.

(2) Determine where the buttonhole is to be and bring forward to Position 'E' all the needles on the left of the buttonhole.

(3) Knit 6 rows. (If a larger buttonhole is desired, knit as many rows as is necessary.)

(4) Break the yarn; take the carriage off the needle bed and replace it on the other side.

(5) Return the needles that were in position 'E' to Position 'C' (using the plastic picker carriage), and bring forward the needles on the right to Position 'E'.

(6) Knit the left side of the buttonhole, the same number of rows as for the right side.

After you have completed the same number of rows raise the H.C.L.'s to Position I and continue to knit.

Instructions are given for the carriage on the right side of the bed.

How to knit a Pocket

(1) Determine the position of the pocket, and bring forward to Position 'E' all the needles on the left of the pocket.

(2) Lower both H.C.L.'s to Position 2 (centered).

(3) Knit one row and bring forward to Position 'E' all the needles on the right of the pocket.

(4) Knit one row again.

(5) The carriage is now on the right and you can knit the amount of rows required for the pocket. Move the carriage across slowly with one hand and put the other hand behind the fabric and pull the knitting down slightly. Finish the complete pocket with the carriage on the right.

(6) Push the needles on the left back to Position 'C' (using the picker carriage) taking care not to let the stitches fall over the latches.

(7) Knit one row, and raise the right side H.C.L. to Position I.

(8) Continue knitting the garment.

The pocket can now be pulled through to the side of the fabric facing you. To complete the pocket sew up (or weave) the stitches at the sides.

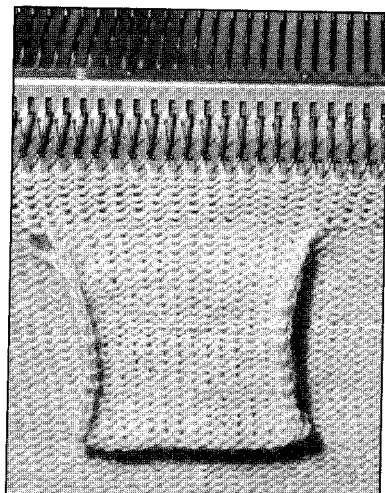
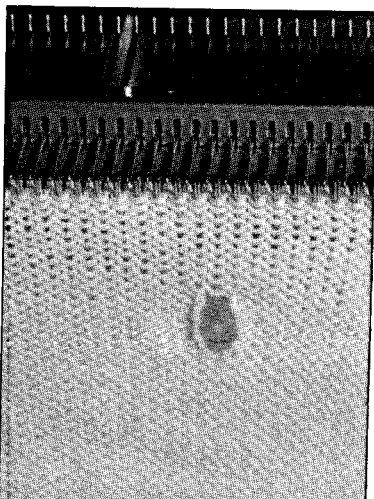

Shaping a 'Vee' neck

34

Knit the fabric to the row where the 'V' neck commences. The instructions are written to start with the carriage on the right side of the bed. If the carriage is on the left then read LEFT for RIGHT and vice versa.

- (1) Place both H.C.L.'s on II.
- (2) Bring forward to Position 'E' all the needles on the left side of the centre 'O'. These needles will not knit until the right side is completed. (If you wish you may take them off onto a knitting needle and replace them later).
- (3) Transfer the first stitch on the right of 'O' to the adjacent needle on the right (in Pos. 'B') Return the empty needle to Pos. 'A'.

N.B. FOR FULLY FASHIONED – transfer both first and second stitches onto the second and third needles, and continue transferring *two* at a time.

- (4) Knit two rows.
- (5) Continue decreasing one stitch every two rows until you have the required number of stitches left for the shoulder. Bind off these stitches and break the wool.
- (6) Return all needles at left to Pos. 'B' by putting three at a time onto a transfer tool, and slipping the stitches *inside* the needle hooks (i.e. not behind the latches). Knit this side identical to the other.

N.B. If you are doing a pattern using the H.C.L.'s, then after bringing the needles (for the pattern) forward with the Set Lever – they will have to be returned by hand. To do this just push the needle back to Position 'C', and it will knit together with the other needles in 'B'.

KNITTING THE HEM TO THE 'V' NECK

Bring forward to Position 'B' the number of needles required for HALF the neck and back of garment.

Open the latches of all these needles.

Set the carriage and machine dials as for Plain Knitting. With the wrong side of work facing you, and using the one eyed transfer tool, pick up the 1st stitch nearest to the 'V' onto the first needle nearest to the carriage.

Now continue to raise all the stitches from the half 'V' onto the empty needles. (You may prefer to have the hem tighter and therefore raise all the stitches onto $\frac{1}{2}$ the corresponding number of needles. To do this, miss out every 4th stitch and raise every 5th stitch onto every 4th needle).

IF YOU WISH TO DO THE NECKBAND IN ONLY TWO PIECES THEN RAISE HALF THE STITCHES FROM THE BACK OF THE GARMENT ONTO THE NEEDLES AFTER RAISING HALF THE NECK STITCHES.

With the same yarn knit one row across (N.B. All needle butts should be in Position 'B').

YOU CAN NOW KNIT THE HEM

The bottom end of the hem should be mitred (for the V shape), by decreasing at the 'V' end until the hem is halfway through. Now increase in reverse order so that when the hem is completed you have the same number of stitches on – as when started.

REPEAT THE SAME PROCESS FOR THE OTHER SIDE OF

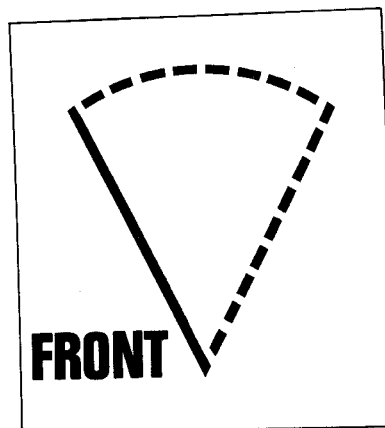

Shaping a round neck

Shaping a square neck

Round neck

Instructions are given for the carriage on the right side of the needle bed.

- (1) Place the H.C.L's on Position II.
- (2) Bring forward to Position 'E' all the needles on the left side of the centre 'O'.
- (3) The decreasing of the stitches is done by bringing forward to Position 'E', the needles you wish to decrease. Start with the needles in Position 'B' on the right of 'O' and knit two rows each time you bring needles forward.
- (4) Decrease in this manner until you have the required number of stitches left in Pos. 'B' for the shoulder.
- (5) Bind off these stitches and break the yarn.
- (6) Return the needles on the left back to Position 'B' and repeat as above, from 3 to 5. Remember to leave the same amount of needles for the shoulder. Bind off these stitches.
- (7) Place the end stitches of the round neck onto the knitter.
- (8) Place the carriage on the left and thread the yarn feeder. H.C.L's on Position I.

KNITTING THE HEM:

- (9) Knit the first half of the hem (approx. 5 rows) on a normal tension for that yarn.
- (10) Knit one row on a tension 3 numbers higher. This will ensure that the fold will be flat.
- (11) Knit the other half of the hem on the same tension as used in No. 9. (N.B. It must be the same amount of rows as the first half).
- (12) Using the transfer tool, raise the stitches from the end of the round neck onto the needles. Take care to raise each stitch onto the corresponding needle to obtain a perfect round effect.
- (13) When all the stitches have been raised, bind off the double stitches in the normal way. N.B. Seal the stitches by hand very loosely, to allow for the neck to fall back into place after removing the knitting from the machine.

Square neck

Cast off the needles in the centre, for the width of the neck, using the same wool as that for the garment. Return needles to Position 'A'. On the opposite side to the carriage bring forward all the needles to Position 'E'. Lower both H.C.L's to III. Knit the required number of rows to complete the side nearest the carriage. Cast off and return the needles to Position 'A'. Raise H.C.L's to I and knit other half identical to first.

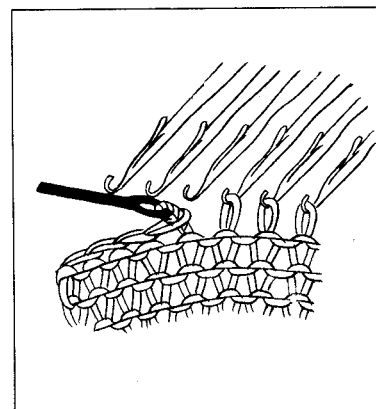
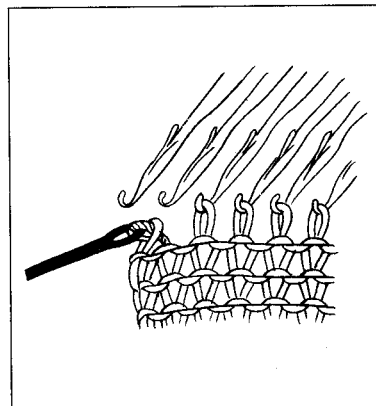

SHORT ROW DESIGNING

This method of shaping has endless possibilities and is used most frequently for:
Turning the heel of socks;
pockets; horizontal darts;
circular piece-yokes, skirts and zig-zag designs.

Set both H.C.L.'s to Position III, then put one or more needles in Position 'E', so that these needles stop knitting and hold the stitches for further use.

TWO COLOUR DIAGONAL KNIT (USING SHORT ROW METHOD)

- (1) Start with the carriage at the right and both H.C.L.'s on Position III.
- (2) Raise two needles on the left to Position 'E'.
- (3) Knit one row to left and pass the yarn under the stem of the needle in Position 'E' on the right. Knit one row to the right.
- (4) Continue raising two needles and knitting 2 rows as above, until all needles are in Position 'E'.
- (5) Change the yarn; remove carriage from the right side and place on the left side of knitter. Starting at the left push into Position 'C', two needles at a time, and knit one row to the left and one to the right. (Reversing the previous process until all needles are back in knitting position.)

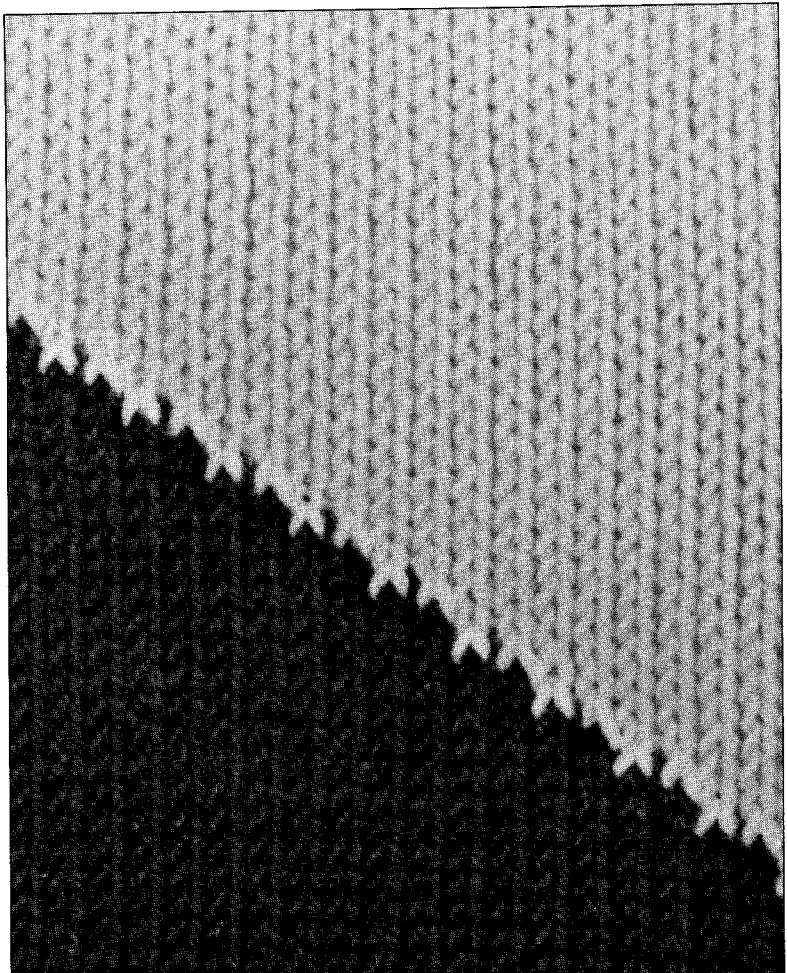
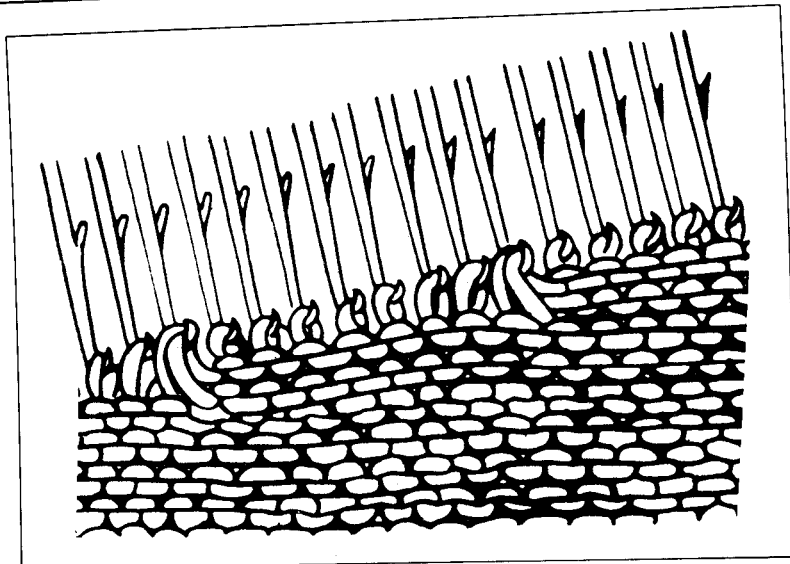

The most comprehensive knitting machine pattern stitch book ever produced is now available!

Page 37~47 apply mainly to models 588,585 and except for lace, the 580.

37

We have done it again!
We have compiled a hard cover manual of over 1,200 different pattern stitches that can be produced automatically on your machine.

There are 370 pages – 48 in full colour, and all packed with beautiful stitches and new ideas that have never been published before!

This enormous selection of fancy stitches – all with full illustrated instruction charts – includes weaving, lace, Fair Isle, woven-lace combinations Afgan, ribbing, as well as new useful ideas on motifs, embroidery on knitting and crochet.

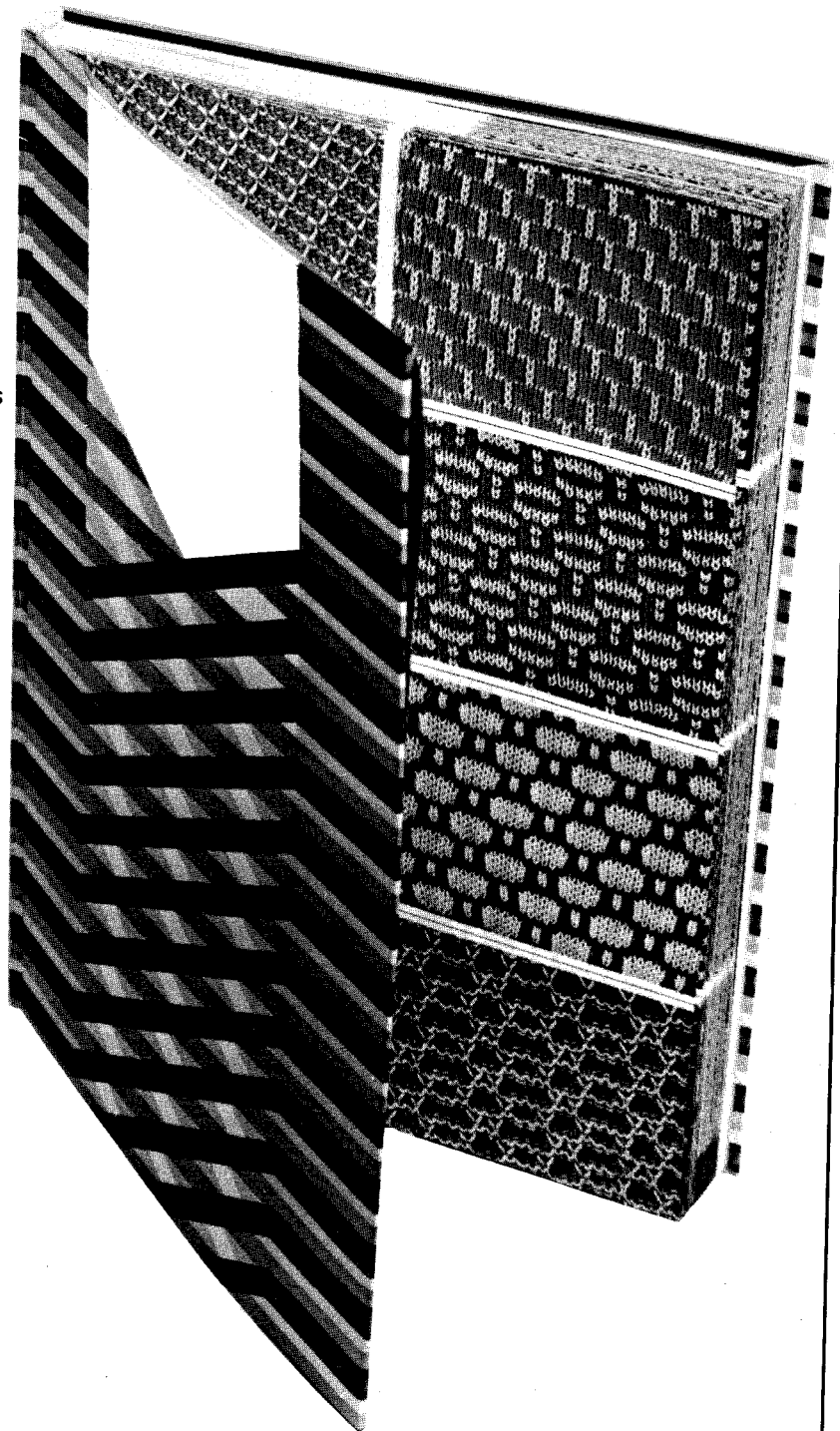

How to use the pattern centre

38

As previously explained on page 9, there are six different positions of the needles (A, B, C, D1, D11 & E).

The pattern centre is used to select the needles you wish to use (always in sequences of 2, 4, or 8) and bring them forward into action – for producing the pattern.

CHANGE LEVER

This control has two settings, N and MC.

N. When in this position the set lever brings the selected needles to position D1. Use this setting for all patterns except colour work.

MC. When set on MC the selected needles are brought forward to D11 by the set lever. This position is used for fairisle and colour patterns.

SELECTING THE NEEDLES

Bring forward the number of needles you require to Position 'B' (with both H.C.L.'s on I run the carriage across and back to straighten the needle butts). Turn the reverse lever (immediate right of buttons) to +.

Change lever to N.

(1) Depress button No. 1. (See Fig. 98).

(2) Swivel the Set Lever as far left as it will go. This will push forward every corresponding eighth needle to Position 'D'. (By moving the carriage across now, this will return these needles to Position 'B'. They may also be pushed back by hand if the wrong selection was made). (See Fig. 99).

(3) The Red button on the left (numbered 0) is used to release any other buttons that are depressed. It does not remain down. (See Fig. 100).

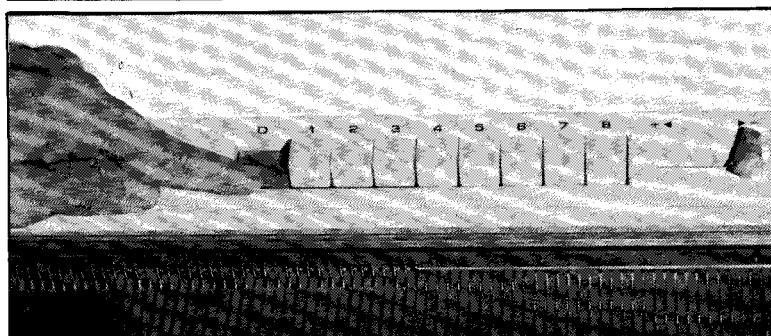
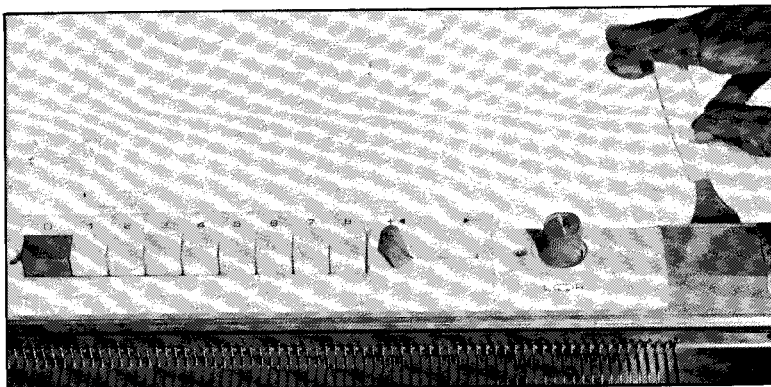
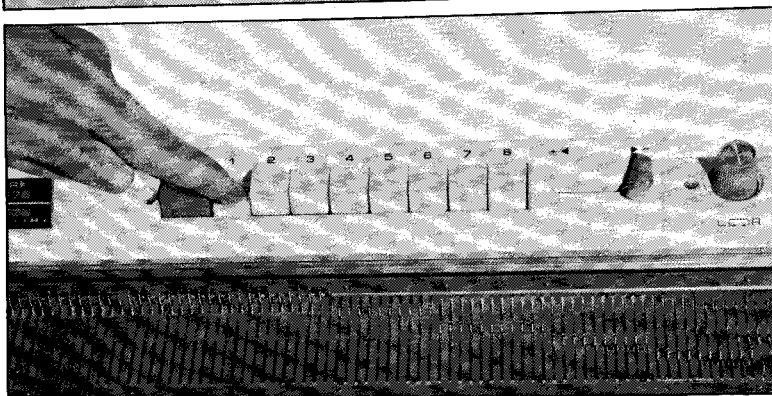
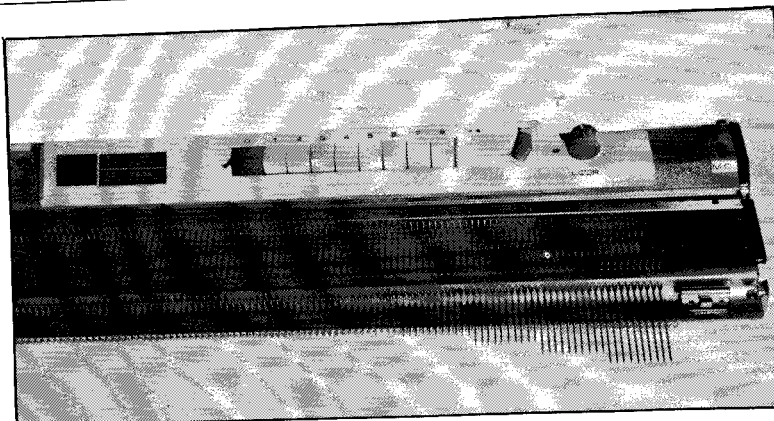

NEEDLE SELECTOR BUTTONS – REVERSE LEVER – SLIDE DIAL

Each button controls each needle group. A combination of pushed down buttons will control the corresponding combination of selected needles.

The reverse lever has two positions + and –.

Position +

The needles corresponding to pushed down buttons can be selected by swivelling the set lever.

Position –

The needles corresponding to unpushed down buttons can be selected by swivelling the set lever.

When the reverse lever is in position –, you can see the figure – on the slide indicator. (For models 580, 585 only) The slide dial is used for sliding the needle selection position and for zigzag and diagonal patterns.

Example

Push down the '1' button, turn the slide dial and set the arrow at 1 on the slide indicator. Swivel the set lever, then the needles on the mark X will be selected.

Turn the slide dial and set the arrow at 2 on the slide indicator.

Swivel the set lever, then the needles on right side of the mark X will be selected. The slide direction indicator indicates the direction in which the slide dial has last been turned.

Relation between the needle selector buttons and the needles are shown in this figure.

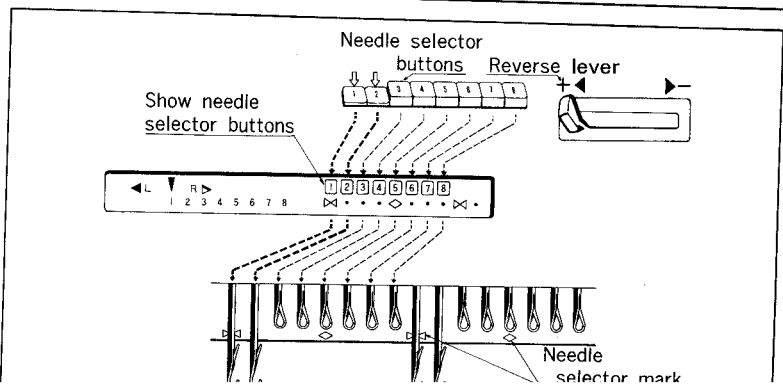
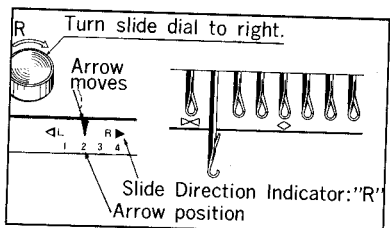
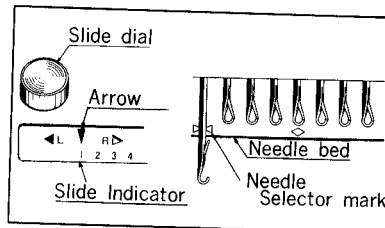
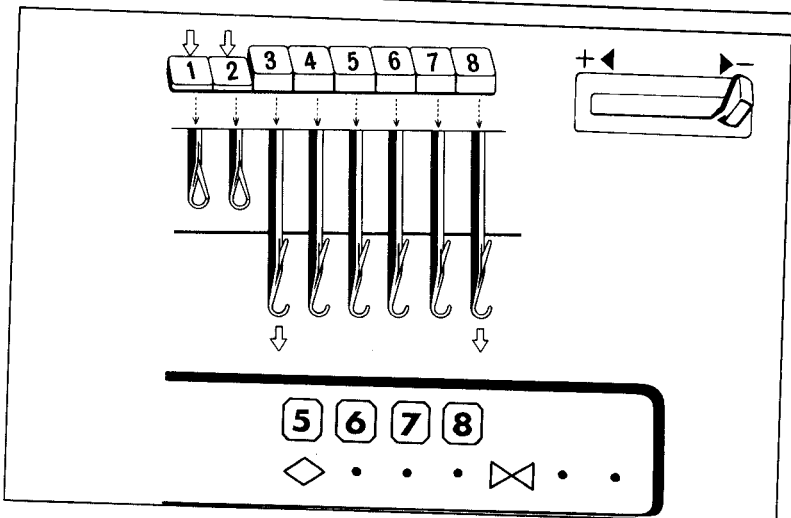
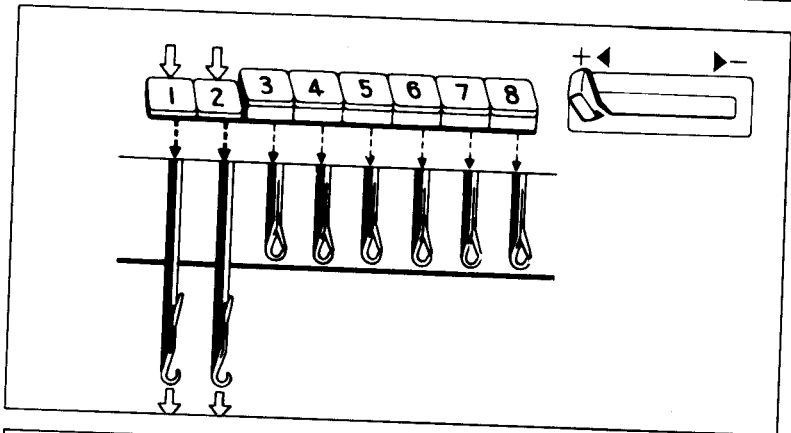

Explanation of the pattern cards (charts)

40

THE PATTERN CHART IS READ FROM THE BOTTOM UPWARDS – and each step (normally a row) should be followed starting from RIGHT to LEFT.

STEPS – The required operation for each step or movement of the carriage is shown in the horizontal column of the step.

CARRIAGE DIRECTION – Move the carriage according to the direction of the arrow. The double arrow means two rows without stopping. Before Step 1 the carriage should be *on the right*.

COLOUR (All models except 588 – 588 see page 43) – This shows the colour of the yarn in the feeder.

'A': Main colour.
'B' or 'C': 2nd or 3rd colours.
The figure '0' means that the carriage must be moved across without knitting (PART).

TENSION DIAL

The number shown here is the tension on the carriage dial, that this pattern was knitted in. The tension differs for each type of wool, and therefore this number can only be used as a guide. A test piece in the wool you are using will have to be knitted, and if need be, the tension altered.

H.C.L. LEFT

The position for this lever on the carriage is shown in the relative square for each step. The two dashes (") denote that the setting remains the same as that for the previous step.

CARRIAGE

These are the 5 buttons on the carriage. If a square is blacked in, it means that this button must be depressed. The two dashes (") indicate that the setting remains as for the previous step.

H.C.L. RIGHT

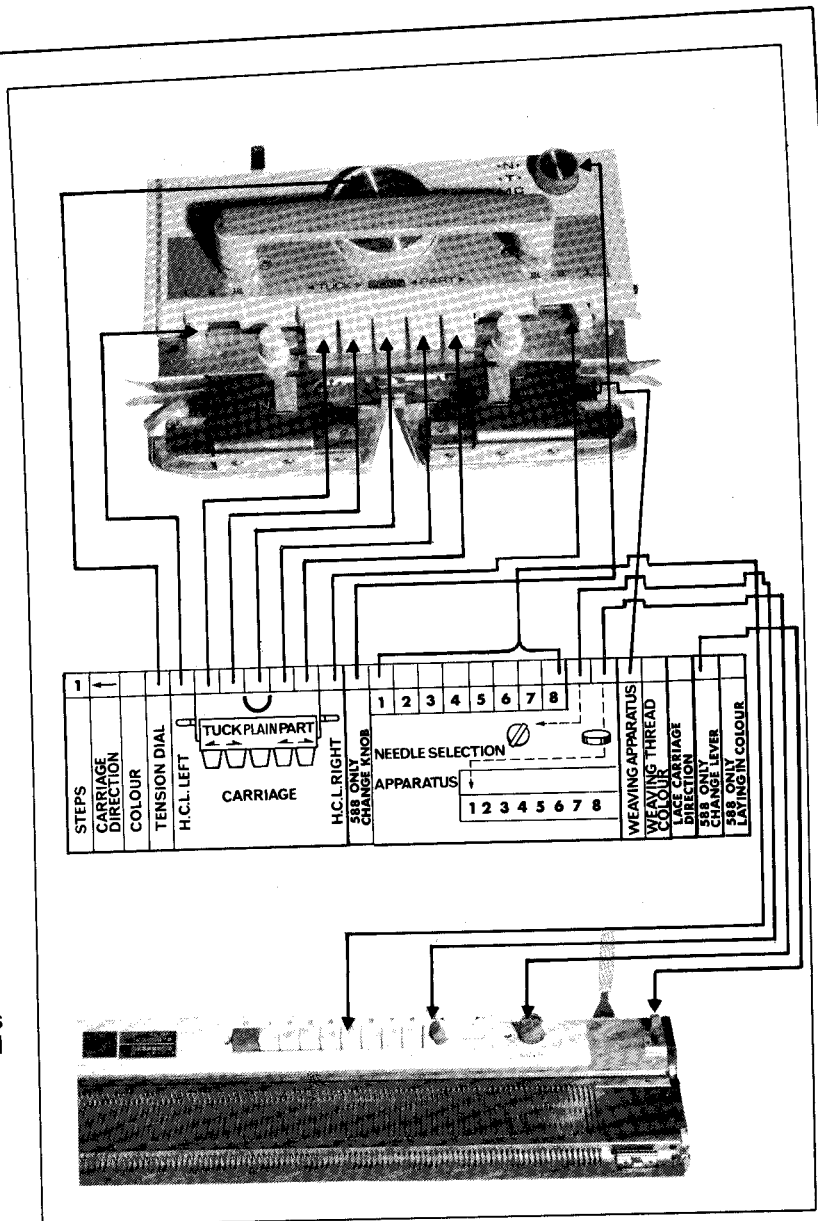

COLOUR WORK

Both H.C.L.'s to 1. Plain button pressed. Change knob to MC. Change lever to MC. Reverse lever on +. Knit two rows. This brings the needles forward to work in position D1.

Stop with carriage at right hand end. Press both part buttons in.

To knit pattern illustrated on right, press buttons 1, 2, 3 and 4. * Set lever (this brings forward selected needles to D11). Lay in contrast yarn as diagram X. Knit across. Repeat in opposite direction*. Repeat from * to * three times. Turn reverse lever from + to -. Repeat from * to * three times. Every sixth row the reverse lever is alternated between + and -.

N.B. When laying the contrast yarn across the needles make sure the latches are open and that a slight pressure is maintained on the yarn to avoid looping.

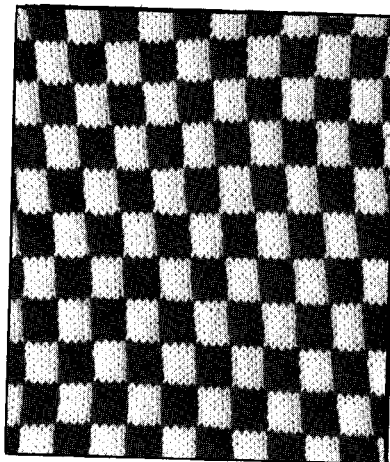
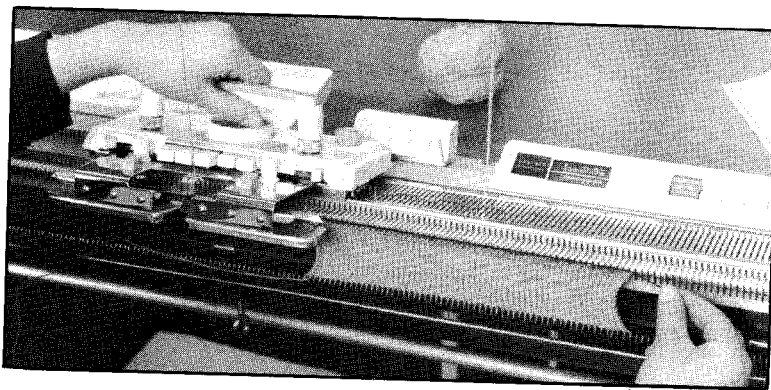
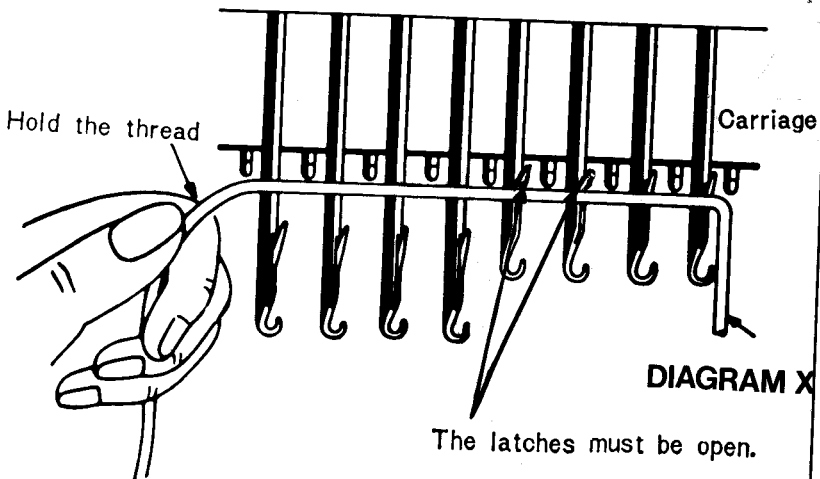

12				X	X	X	X		
11				X	X	X	X		
10				X	X	X	X		
9				X	X	X	X		
8				X	X	X	X		
7				X	X	X	X		
6	X	X	X	X					
5	X	X	X	X					
4	X	X	X	X					
3	X	X	X	X					
2	X	X	X	X					
1	X	X	X	X					
	1	2	3	4	5	6	7	8	

N.B. Each step represents one row of knitting.

Fair-Isle pattern knitting

All models except 588

44

The principle of knitting different fair-isle designs is to knit certain needles (stitches) in one colour; and then to knit the remaining stitches for that row in the second, or second and third colours. The knitting of the remaining stitches is sometimes referred to as 'filling in the background'. If only two colours are used then the reverse dial performs this automatically, as it selects all the needles that have *not* been selected by depressing the buttons.

The setting of the carriage is the same for all fair-isle designs; only the settings of the needle selection is different for each pattern.

The carriage is set as follows:
 (1) Both H.C.L.'s on Position I.
 (2) Both PART buttons (left and right) pressed in.

With this setting of the carriage the needles that will knit will be those in Position 'C' (brought forward with the Set Lever) or those in Position 'D' or 'E' (brought forward by hand).

The needles remaining behind in Position 'B' will not knit at all. In fair-isle patterns the stitches in one colour are normally knitted for two rows, and then two rows of the second colour. In this way the changing of colours has to be only on one side of the machine.

Remember that when knitting fair-isle in two colours every four movements of the carriage is only *two* rows of actual knitting, and the row counter will therefore register twice as much as is required.

When the width of the fair-isle pattern is more than eight stitches, the needle selector buttons cannot be used, and the required needles have to be brought to Position 'E' by hand. In the same way the needles to fill in the background also have to be brought forward by hand.

HOW TO CHANGE THE WOOL FOR TWO COLOUR WORK

Thread both colours into the Yarn Tension Unit as shown in Fig. 101.

Take the 1st colour out of the

carriage yarn feeder and hang it onto the end of the needle bed. Thread the second yarn into the feeder, and move the carriage slightly sideways until the yarn (from the feeder to the knitting) comes up on top of the lower sinker plate.

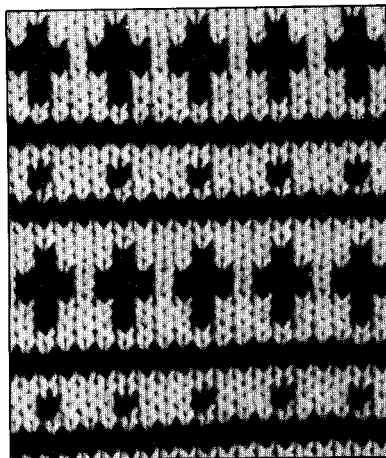
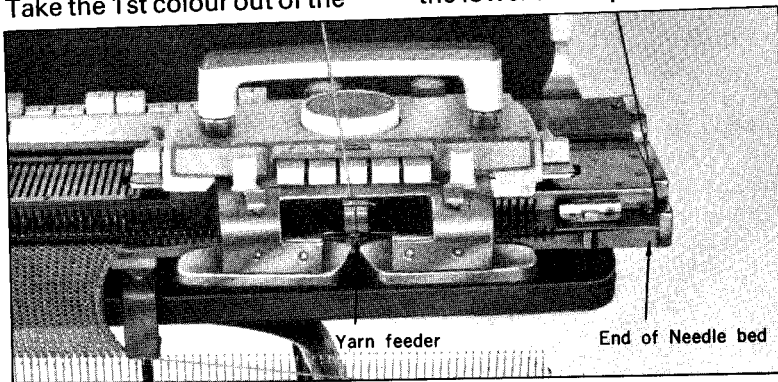

13			X				X	
12								
11	X	X	X	X	X	X	X	X
10								
9			X				X	
8		X	X	X		X	X	X
7			X				X	
6								
5	X	X	X	X	X	X	X	X
4								
3			X				X	
2								
1	X	X	X	X	X	X	X	X
	1	2	3	4	5	6	7	8

N.B. Each step represents *two* rows of knitting (i.e. total 26 rows).

How to weave on your machine

45

PRINCIPLE OF WEAVING

The weaving (or laying-in) apparatus is built into the knitting carriage. The weaving is done at the same time as knitting a row.

To set the carriage for weaving in both directions : push forward both buttons on either side of the sinker plate unit to Position 'T' : Change knob to T. Change lever to N.

N.B. The H.C.L's must both be in Position 1 when weaving.

The best woven material effect is obtained when the wool you are using to knit is very thin (2 or 3 Ply) and the weaving wool is thick (Double or Triple Knit).

HOW TO WEAVE

The thread is woven into the side of the knitting facing you, by it being placed above and below the needles you are knitting. The wool does not then enter the hooks of the needles, and can be pulled out after knitting, without dropping the stitches.

The method of forming a weaving pattern is to select the required needles (by pressing the buttons) – to set these needles forward, and lay the weaving wool across these needles.

Now move the carriage across to knit the row.

On inspection it will be seen that the weaving wool has gone *above* the needles you have brought forward ; and *below* the needles that were not brought forward. The actual path of the wool over eight stitches is shown on the stitch symbol graph, next to the pattern chart.

For Example : in the stitch symbol of the pattern shown, for the first row the wool has gone over needle No. 1, under 2, 3 and 4, over 5 ; and under 6, 7 and 8. For the second row the slide dial has been moved to No. 2 – therefore the same needle setting is obtained but the pattern is moved over to every adjacent needle on the right.

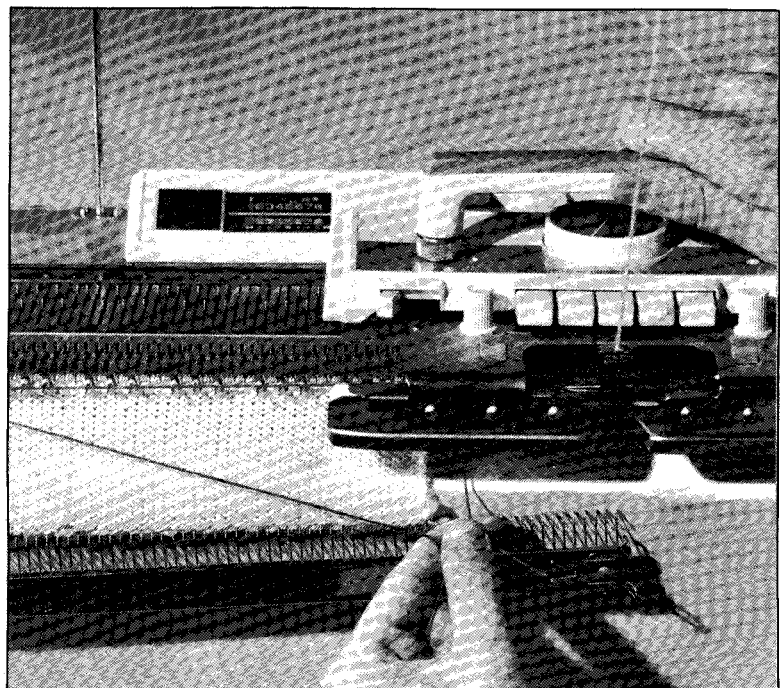

Automatic lace patterns

48

FOR MODELS 585 & 588 LACEMAKER ONLY.

Your Knitting machine incorporates a built-in Lace device which is used to transfer the stitches to the adjacent needles AUTOMATICALLY.

PREPARING THE 'L' CARRIAGE

Remove the auxiliary rails from the carrying case.

(See Fig. 103).

Insert each rail into the hole at the edge of the machine (A) and under the rail fastener (B) on the lower needle bed.

(See Fig. 104).

Fasten the second handle onto the 'L' carriage.

(See Fig. 105).

If you are using a 2 Ply wool or lace cotton, fit the wool wax onto the front yarn guide.

(See Fig. 106).

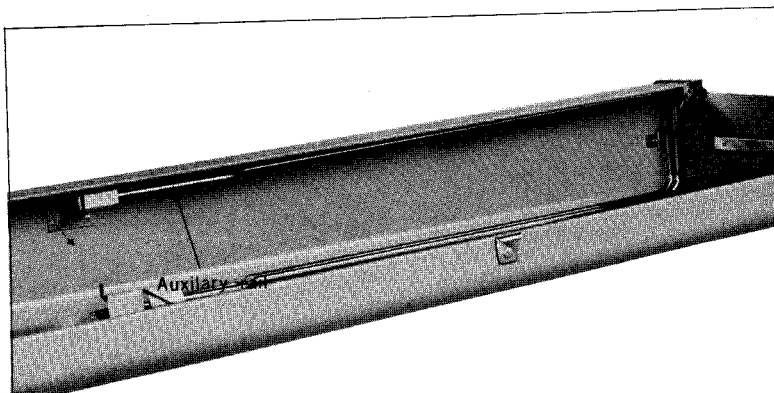

103

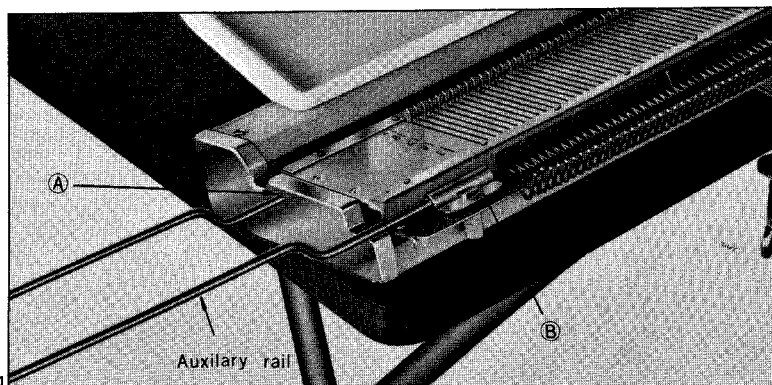

104

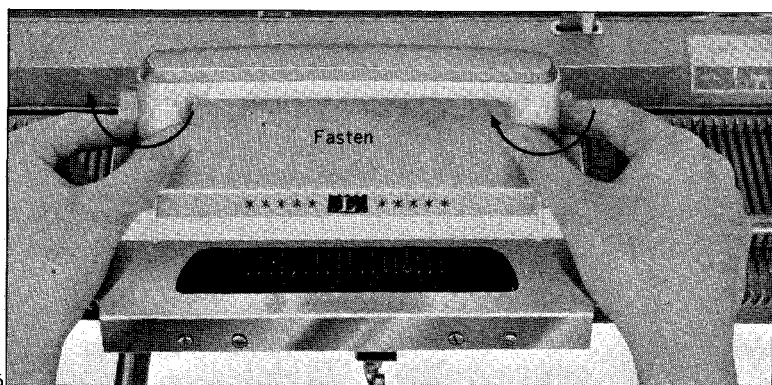

105

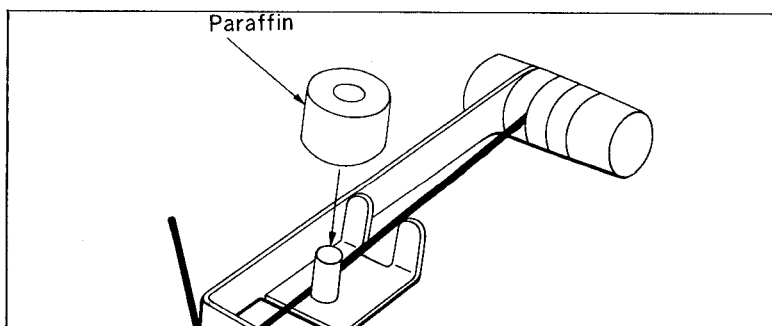

106

Knit several rows in plain stitch, and hang the claw weights onto the cast on comb. (See Fig. 107).

Swivel the Set Lever and set the needles according to the pattern chart (See Fig. 108). The lacy carriage will transfer the stitches from the needles that are set, onto the adjacent needles in the direction that the 'L' carriage is moved across. It will only transfer onto a needle that is in B Position.

107

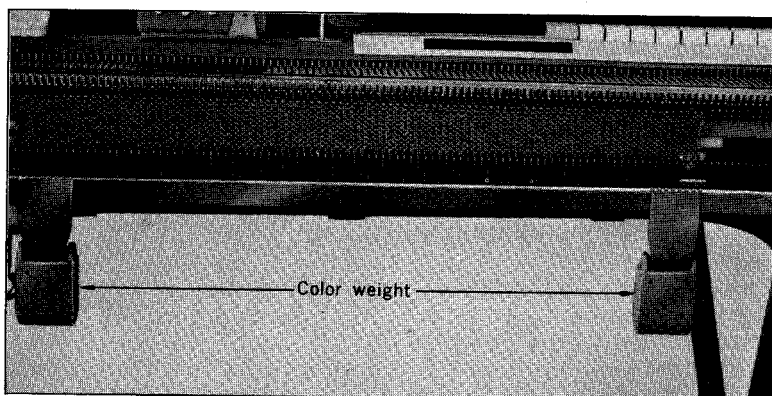

IT IS IMPORTANT THEREFORE THAT NO TWO (OR MORE) ADJACENT NEEDLES ARE BROUGHT FORWARD TOGETHER. (See Fig. 108).

In the event that an end needle is brought forward (on the side away from the carriage) it should be pushed back by hand to Position B. You can do this without fear of the stitch dropping. (See Fig. 109).

108

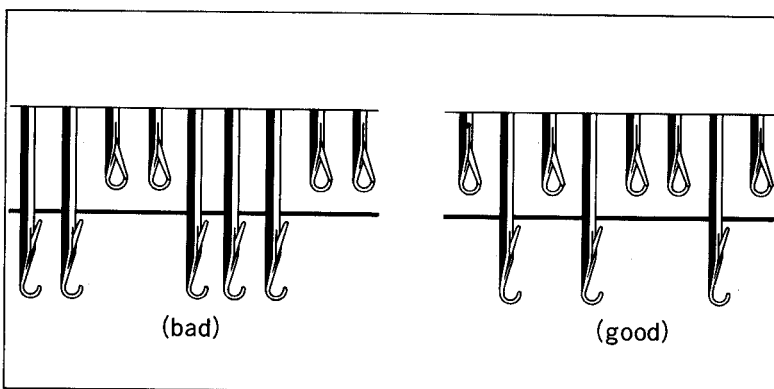

109

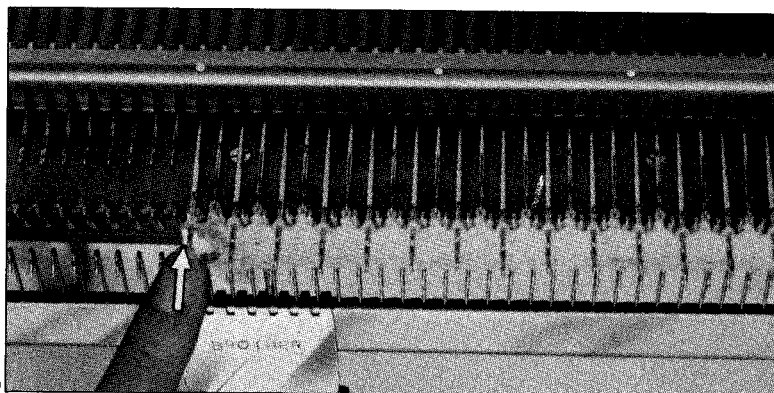

FITTING THE 'L' CARRIAGE

The needles at the side of those you are using must all be in Position A.

Put the front part of the carriage around the needle gate, and lower the back part onto the needle bed.

(See Fig. 110). The clip at the back should go under the back rail of the needle bed. Move the carriage sideways to check that it is firmly in place. 110

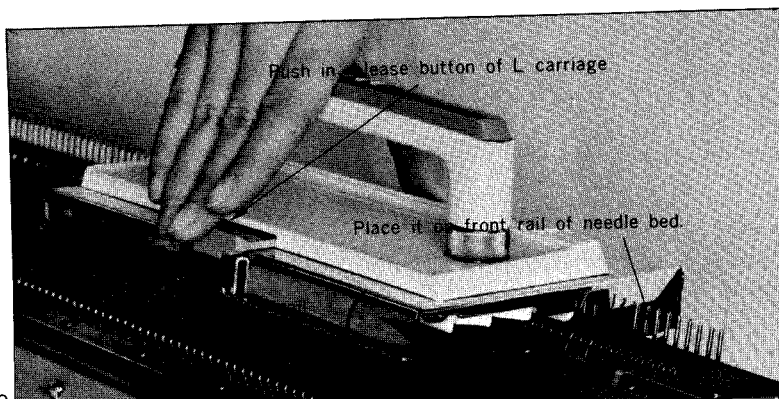

IF THE 'L' CARRIAGE SHOULD JAM DURING KNITTING REFER TO PAGE 54 TO RELEASE IT.

To unlock the carriage press the blue button at the back and release it from under the rail. (See Fig. 111).

To rest the 'L' carriage on the auxiliary rail, place it firmly in position as shown. (See Fig. 112).

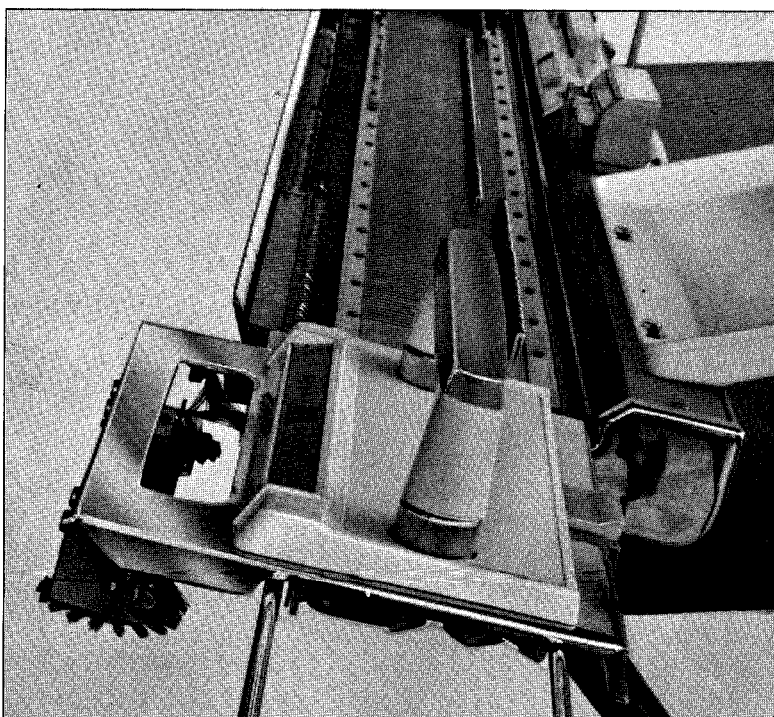
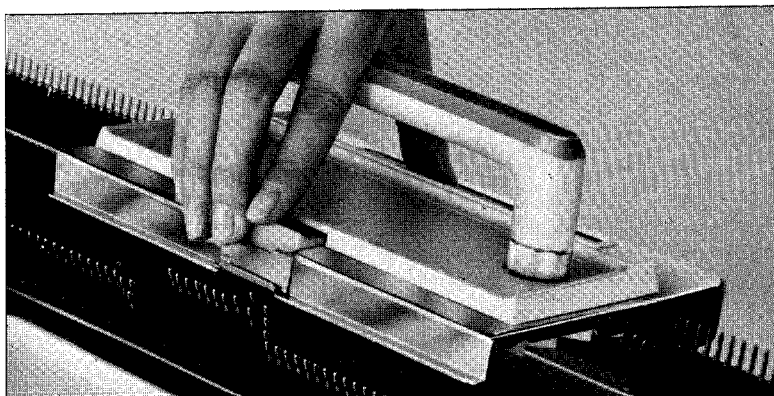

ALL THE INSTRUCTION ON THE MACHINE IS NOW FINISHED AND YOU SHOULD GO BACK AND PRACTICE THE THINGS YOU ARE NOT SURE OF

CLEANING AND OILING.

A bottle of oil is supplied in the accessory box. Remove the cap and check that the oil flows through onto the bristles.

Clean the needle bed and the carriage slide rails with a clean 113 cloth. Oil the front and rear rails lightly. (See Fig. 113).

Oil the butts of the needles lightly, making sure that it does not overflow and run down the needles below the bed. (See Fig. 114).

After wiping the carriage clean, oil the sides of the moving cams, and the front and back rails. Oil also the sides of the nylon plastic runners in the centre.

YOU SHOULD CLEAN AND OIL YOUR MACHINE BEFORE USING IT EVERY TIME.

114

It is important to remove well all excessive oil to prevent drying up or staining of your wool. Always leave a light film of oil on all parts between the rails under the carriage.

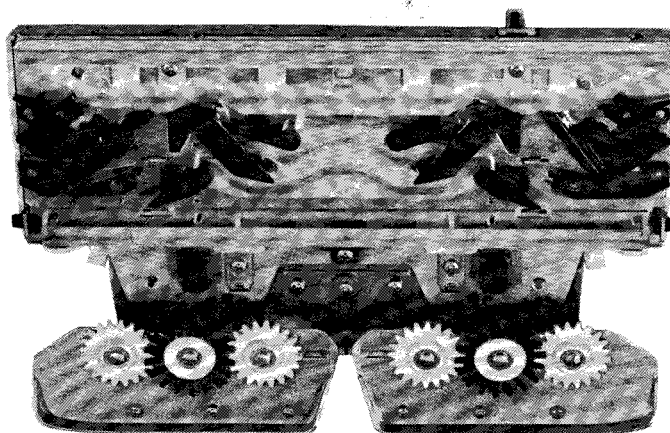
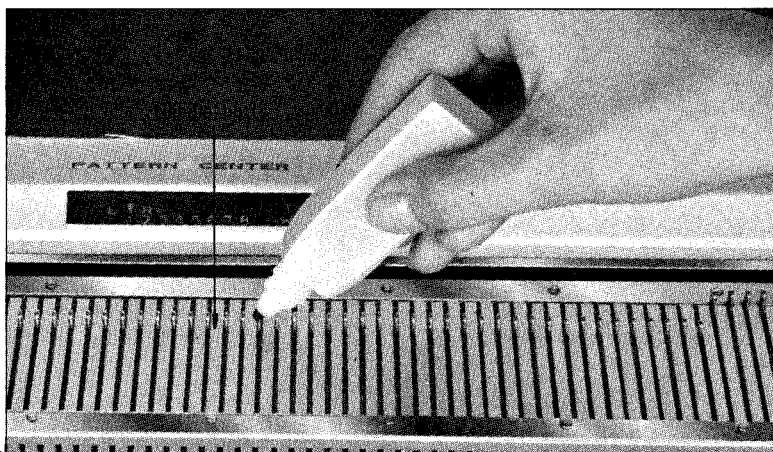
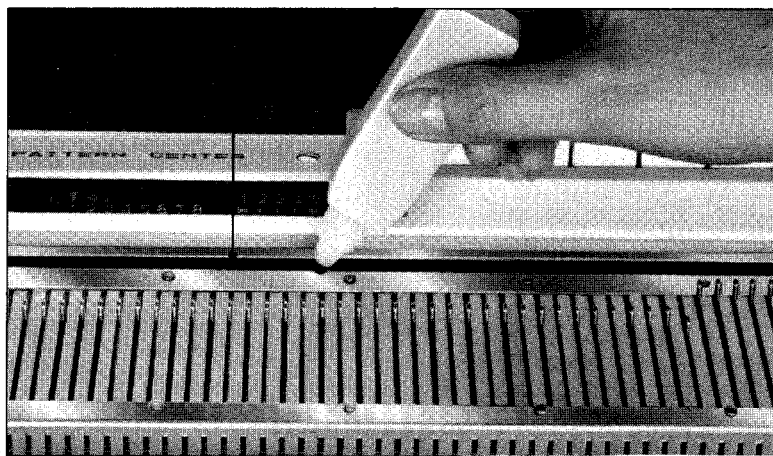

IF THE 'L' CARRIAGE SHOULD JAM

Remove the 'L' carriage from its jammed position.

If the 'L' carriage is caught with the needles, take care in removing it.

After removing the 'L' carriage, you can knit according to the following steps.

(1) If you see needles caught with each other, separate them by lifting their tips.

(2) If stitches are caught on two needles as shown by (a) in above figure, pull selected needles (b) toward you and push them back together with needles (c) to position 'B' in order to transfer the stitches.

(3) For other part, transfer the stitch of selected needles (b) with the transfer tool to the adjacent needles. (For use of the transfer tool, see page 26).

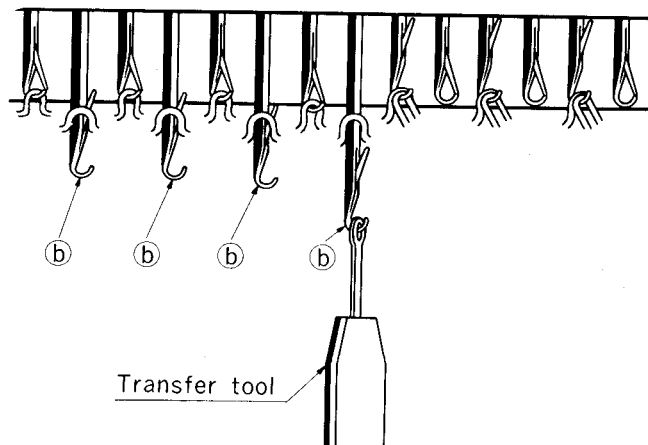
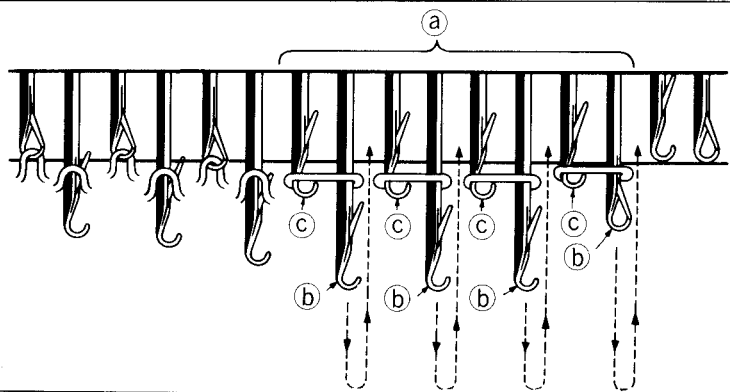
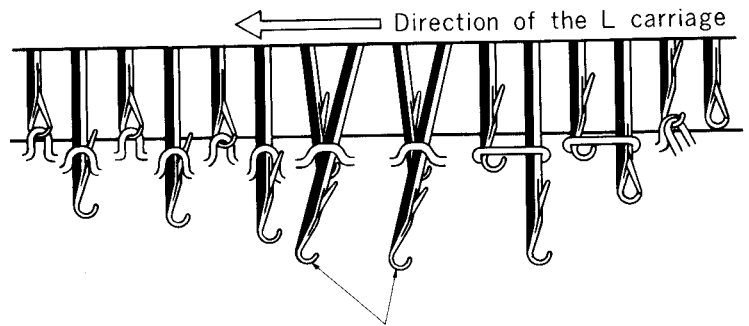

HOW TO REMOVE THE WEAVING BRUSHES

How to remove the weaving brushes
Set the laying-in pattern knobs to position 'N' and remove the laying-in pattern brushes from the sinker plate assembly.

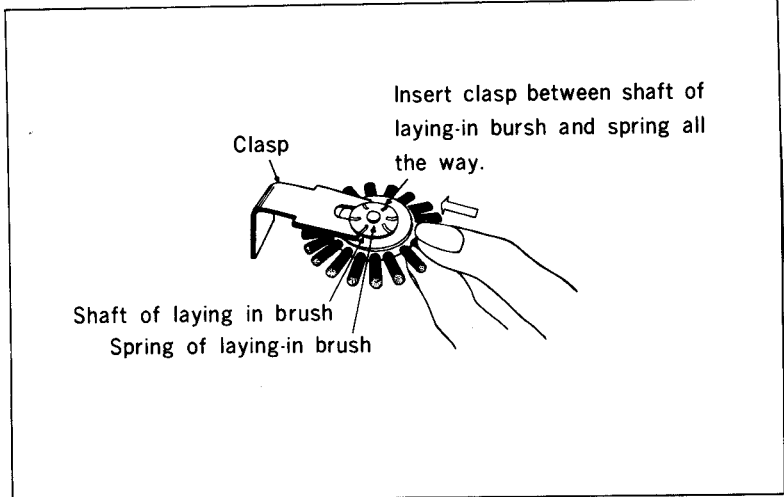
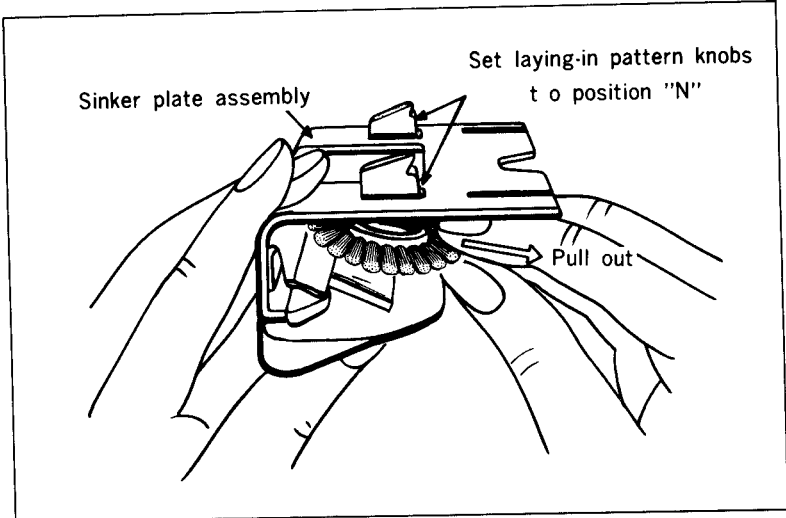

REPLACING A BENT OR BROKEN NEEDLE

(1) Push either side of the felt bar with the end of the latch tool until it comes out.

(2) Withdraw it by hand from the knitter until the needle you wish to change is free.

(3) Pull the needle forward as far as it will go. Push down the hook of the needle until shank end of the needle rises clear of the needle bed.

(4) Grasp the shank end and draw it out backwards.

(5) Replace it with a new needle by holding it with latch opened. Push the felt bar back into place.

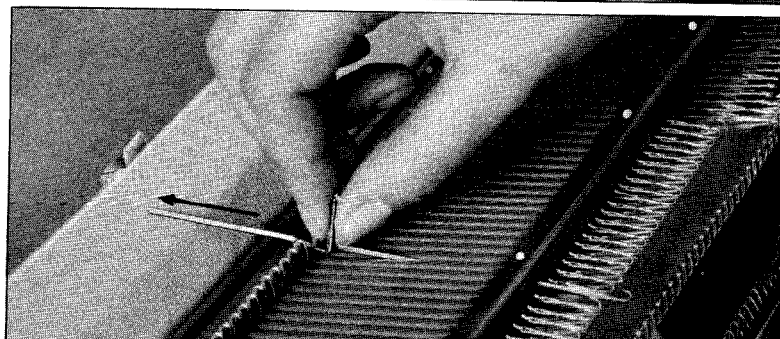
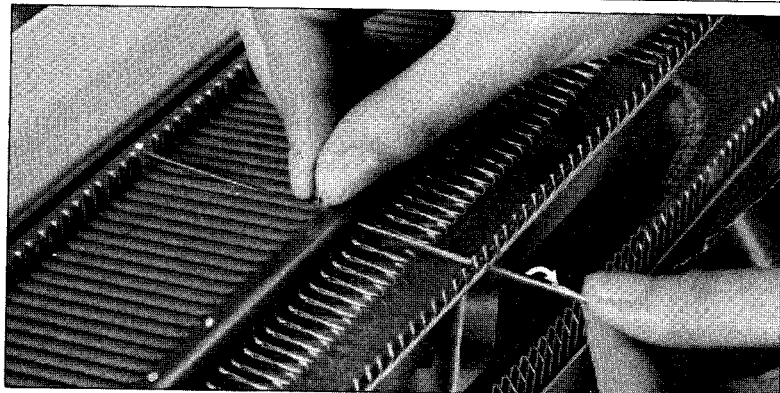
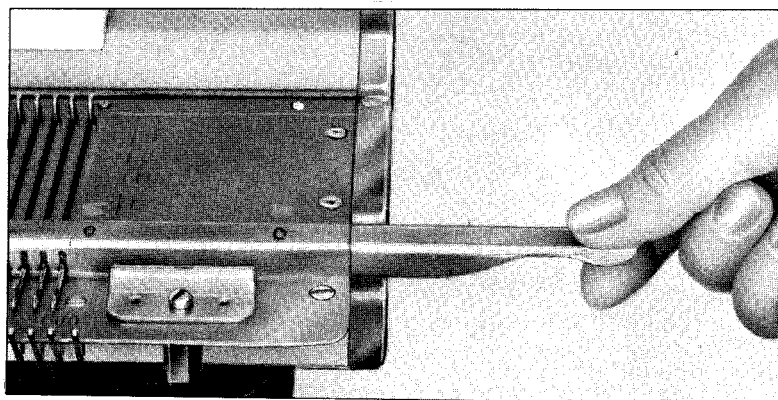
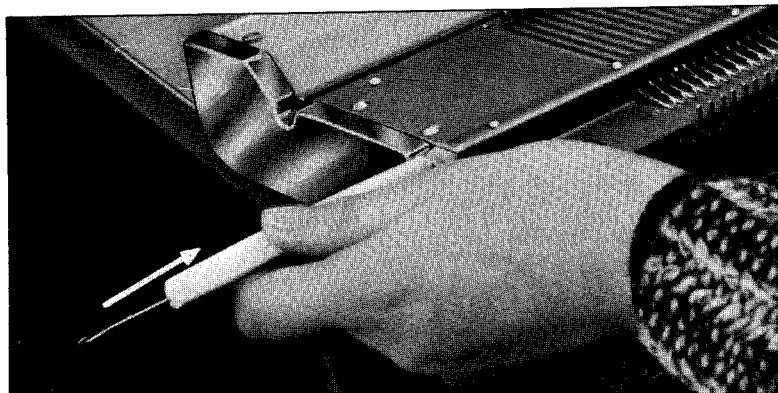

Trying your first garment

57

CHILD'S TWIN SET

We are continually bringing out new pattern leaflets featuring the latest designs, for use on their machines. To familiarise the newcomer to machine knitting with the instructions on these leaflets, we suggest that you try one of the basic patterns given here for practice.

Materials

Cardigan : 5 (5, 6) oz. Hayfield Regal 4-ply wool (main colour) ; odd amount Hayfield Regal 4-ply wool (contrast colour) ; 4 buttons.
Jumper : 5 (6, 6) oz. Hayfield Regal 4-ply wool ; 3 buttons.

Measurements

To fit a 22 (24,26) inch chest.
Cardigan : Length 13 (14½, 16) inches ; sleeve seam 10½ (11¾, 13) inches. Jumper : Length 12½ (14, 15½) inches ; sleeve seam 10½ (11¾, 13) inches (adjustable).

Tension

14½ sts. and 19½ rows to 2 ins.

Abbreviations

K. knit ; st. (s) stitch (es) ; rep. repeat ; alt. alternate ; beg. beginning ; foll. following ; inc. increase ; dec. decrease ; H.C.L. (s) Holding Cam Lever (s) ; T. tension ; 000. Set Row Counter at 0.

No instructions have been given for the motif, we leave the choice to you.

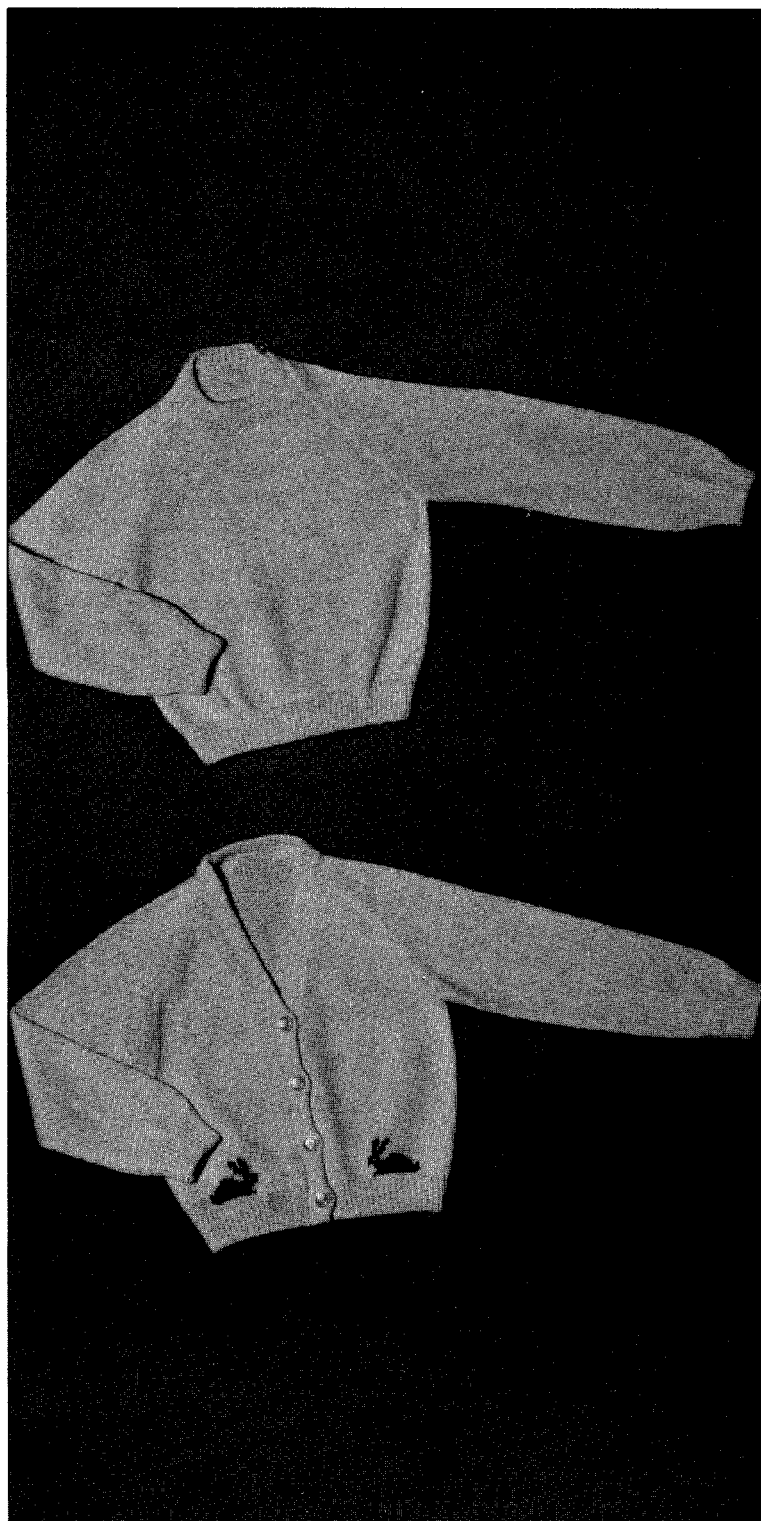

Figures in brackets refer to the larger sizes respectively. Motif is worked by hand. Push required needles to D position. Push both PART buttons. Knit with contrast wool. Push remaining needles to C position and knit with main wool.

CARDIGAN(with motif) BACK

Using odd wool, cast on 44 (48, 52) sts. on alt. needles. K. 7 rows. Change to main wool. T. 3. K. 32 rows. Make a hem by picking up 1 st. row loops of main colour and placing on empty needles. T. 7. 000. Inc. 1 st. beg. next row. (88 (96, 104) sts.) K. until 58 (68, 78) rows have been worked.

Shape raglan armholes

Cast off 3 sts. beg. next 2 rows; 2 (3, 3) sts. beg. next 2 rows. Dec. 1 st. both ends next and alt. rows 25 (27, 30) times. (28 (30, 32) sts.) T. 6. K. 16 rows. Cast off.

RIGHT FRONT

Using odd wool, cast on 22 (24, 26) sts. on alt. needles. K. 7 rows. Change to main wool. T. 3. K. 32 rows. Make a hem as Back. T. 7. 000. Inc. 1 st. at side edge (44, (48, 52) sts.) K. 2 rows. Beg. on needle 17 (19, 21) follow chart for motif. (See notes). K. a further 41 (51, 61) rows.

Shape raglan armhole and neck

Dec. 1 st. at neck edge, cast off 3 sts. at raglan edge on next row. K. 1 row. Cast off 2 (3, 3) sts. beg. next row. K. 1 row. Dec. 1 st. at raglan edge on next and alt. rows. *At the same time*, dec. 1 st. at neck edge on next end foll. 4 rows until 6 (6, 7) sts. remain. Keeping neck edge straight, continue raglan shaping until 2 sts. remain. K. 2 tog. and fasten off.

LEFT FRONT

Knit as Right Front reversing all shapings and motifs.

(30, 32) sts. on alt. needles. K. 7 rows. Change to main wool T. 3. K. 32 rows. Make a hem as Back. T. 7. 000. Inc. 1 st. beg. next row. (56 (60, 64) sts.) K. 7 rows. Inc. 1 st. both ends of next and foll. 14th (12th, 10th) rows 6 (8, 10) times. (68 (76, 84) sts.) K. until 88 (100, 112) rows have been worked. (Adjust length here, if required).

Shape raglan top

Cast off 3 sts. beg. next 2 rows; 2 (3, 2) sts. beg. next 2 rows. Dec. 1 st. both ends next and alt. rows 25 (27, 30) times. Cast off remaining 8 (10, 10) sts.

Buttonhole Border

Join front raglan seam. With wrong side facing, pick up 98 (110, 122) sts. evenly along one front. T. 6. K. 5 rows. Counting from base of garment, make a buttonhole over needles 7-10 (8-11, 6-9) and every foll. 12-15 (14-17, 17-10) needles 4 times altogether. K. 8 rows. Make buttonholes as before. K. 4 rows. Cast off loosely.

Button Border

Knit as Buttonhole Border, omitting buttonholes.

TO MAKE UP

Pin out and press with a hot iron over a damp cloth. Join side, sleeve and back raglan seams. Turn Front Border to wrong side and catch down. Neaten buttonholes. Sew on buttons. Press all seams.

JUMPER

BACK

Using odd wool, cast on 44 (48, 52) sts. on alt. needles. K. 7 rows. Change to main wool. T. 3. K. 32 rows. Make hem as Back of Cardigan. T. 7. 000. Inc. 1 st. beg. next row. (88 (96, 104) sts.) K. until 54 (64, 72) rows have been worked.

Shape raglan armholes

** Cast off 3 sts. beg. next 2 rows; 2 (3, 3) sts. beg. next 2 rows * Dec. 1 st. both ends and alt. rows 25 (27, 30) times, altogether. Cast off remaining

FRONT

Knit as Back to * Dec. 1 st. both ends of next and alt. rows 17 (18, 20) times altogether. K. 1 row.

Divide for neck

H.C.L.'s III. Cast off 12 (14, 16) sts. at centre. Push sts. at left to E position. Knit right part first. Continue raglan shaping, K. 1 row. Cast off 2 sts. at neck edge on next and foll. alt. row. K. 2 rows. Dec. 1 st. at neck edge on next and foll. 4th row (4 (5, 6) sts.). Keeping neck edge straight, continue raglan shaping until 2 sts. remain. K. 2 tog. and fasten off. Knit 2nd side to match.

SLEEVES

Using odd wool, cast on 27 (30, 33) sts. on alt. needles. K. 7 rows. Change to main wool. T. 3. K. 32 rows. Make a hem as Back. Inc. 1 st. beg. row. (54 (60, 66) sts.) K. 5 rows. Inc. 1 st. both ends of next and foll. 20th (18th, 18th) row 4 (5, 6) times. (62 (70, 78) sts.) K. until 86 (98, 112) rows have been worked. (Adjust length here if required).

Shape raglan top

Cast off 2 sts. beg. next 2 (4, 4) rows. *1st. size only*. K. 2 rows. *All sizes*: Dec. 1 st. both ends next and alt. rows 25 (27, 30) times. Cast off remaining 8 (8, 10) sts.

NECKBAND

Using odd wool, cast on 51 (54, 57) sts. on alt. needles. K. 7 rows. Change to main wool. T. 4. K. 3 rows. T. 3. K. 12 rows. T. 4. K. 3 rows. Make a hem as Back. Cast off loosely.

TO MAKE UP

Pin out and press with a hot iron over a damp cloth. Join side, sleeve and raglan seams, *leaving left back seam open for 2½ ins.* Sew neckband in position. Work a row of crochet round opening, making 3 loops on one side. Sew on buttons. Press all seams.

Man's fully fashioned polo neck sweater

MATERIALS: 24 (25, 26) ozs. of any Double Knitting Crepe. This garment shown was knitted in Cambridge D/Crepe available from Mail Order B.K. Wools P.O. Box 25 High St. Heckmondwike, Yorks, only.

MEASUREMENTS: To fit chest 40 (42, 44) in.; length, 26½ (27, 27½) in.; sleeve seam, 17½ (18, 18½) in.

MAIN TENSION: 13 stitches and 18 rows to 2 inches.

ABBREVIATIONS: T. = tension; st(s). = stitch(es); K. = knit; beg. = beginning; dec. = decrease; f.f. = fully fashioned (transfer the 3rd st. onto the 4th needle then transfer the 5th st. onto the 4th needle. 3 sts. on 1 needle. Move the sts. along to fill up the spaces, leaving 2 empty needles at outside edge. Push 1 needle back to A position leaving 1 needle in B position, thereby dec. 1 st. only. To achieve the best results do this dec. at the end away from the carriage); H.C.L's = holding cam levers; 000 = row counter at 0; inc. = increase.

NOTE: Instructions for the larger sizes are in (), where only 1 figure is given this applies to all sizes.

BACK: T. 4. Cast on over alternate needles 70 (73, 76) sts. K. 38 rows. Make a hem by placing each cast-on st. onto empty needles in A position (140 (146, 152) sts.) T. 9 and K. 126 rows. *

Shape raglan armholes: Cast off 2 sts. at beg. of next 2 rows. Dec. 1 st. f.f. at the end of every following row until 42 (44, 46) sts. remain. Cast off.

FRONT: Work as for back until *

Shape raglan armholes: Cast off 2 sts. at beg. of next 2 rows. Dec. 1 st. f.f. at end of every following row until 68 (70, 72) sts. remain

Shape front neck: With a spare length of wool, cast off the centre 20 (22, 24) sts. Push 24 sts. at left to E position. H.C.L's. at Ill and K. the right part only. Continue raglan shaping as before. At the same time cast off 2 sts. at beg. of next 3 rows from neck edge, then dec. 1 st. at the beg. of every following 4th row from neck edge, 3 times in all. After the last dec. at neck edge continue to dec. at side edge only until 2 sts. remain. Cast off. K. the left side to match.

SLEEVES (alike): T. 4 Cast on over alternate needles 34 (36, 38) sts. K. 38 rows. Make a hem as for back. (68 (72, 76) sts.) T. 9. 000. K. 6 rows. Inc. 1 st. at both ends of the next row and every following 6th

row until 110 (116, 122) sts. Work without further shaping until 140 (144, 148) rows from 000.

Shape raglan top: Cast off 2 sts. at beg. of next 2 rows. Dec. 1 st. f.f. at end of every following row until 12 (14, 16) sts. remain. Cast off.

POLO COLLAR: T. 5. Cast on over alternate needles 70 (74, 78) sts. K. 12 rows. T. 4. K. 34 rows. T. 5. K. 12 rows. Make a hem as for back. Cast off loosely.

TO COMPLETE: Press work on the wrong side with a hot iron over a damp cloth. Join raglan seams. Join side and sleeve seams. Stitch polo collar to neck edge.

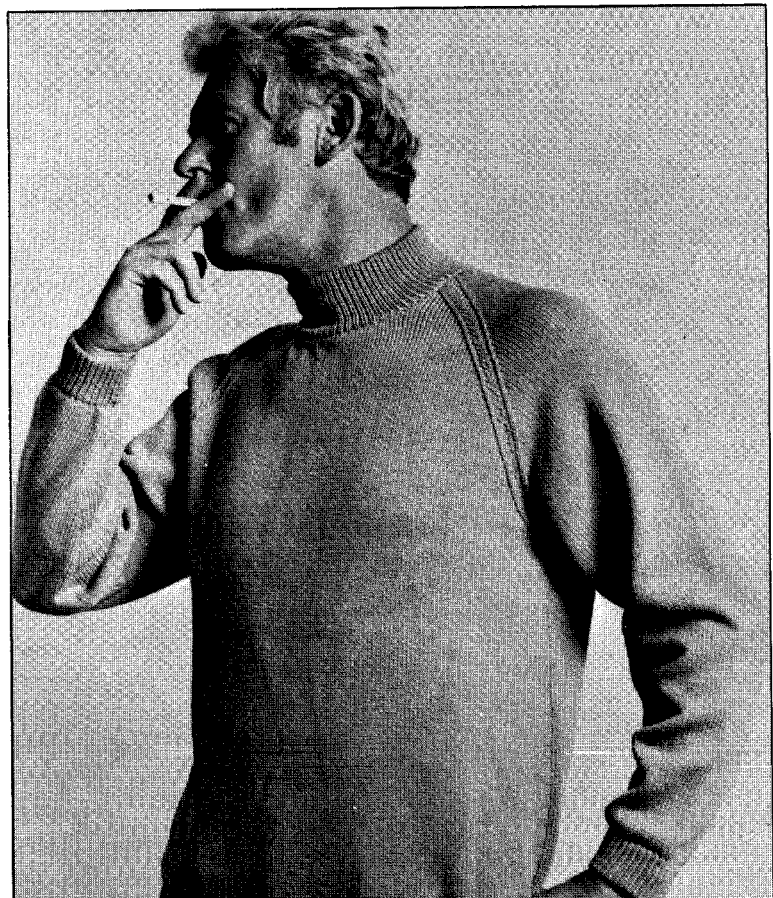

Folding up the knitter

60

FOR MODELS 585 & 588 ONLY

(1) Remove the auxiliary rail (lift up and pull it.)

(2) Replace the auxiliary rails in the upper case as shown in figure.

Open the two clips in the carrying case.

FOR ALL MODELS

(1) Replace the cast on comb in the case.

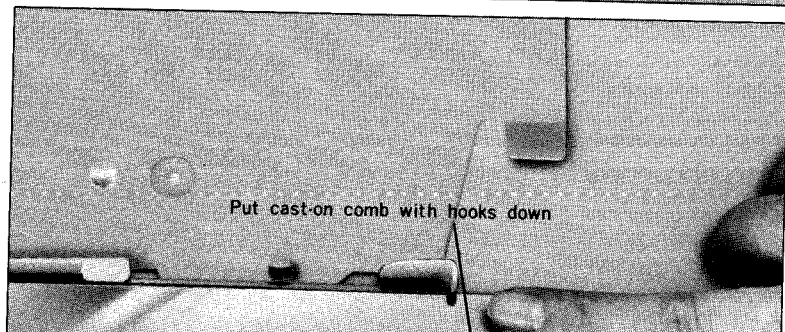
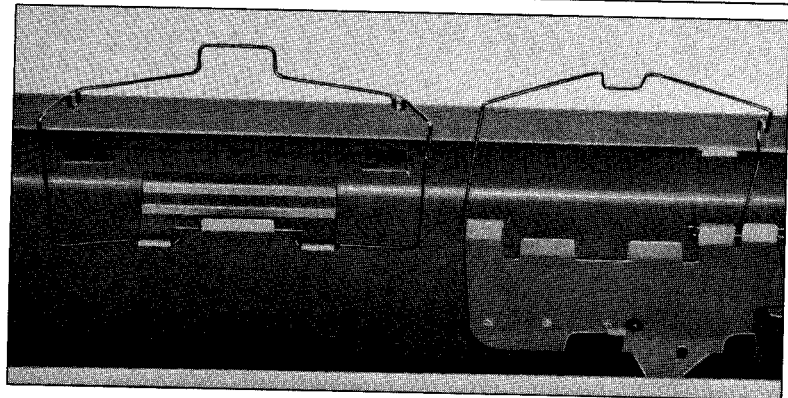
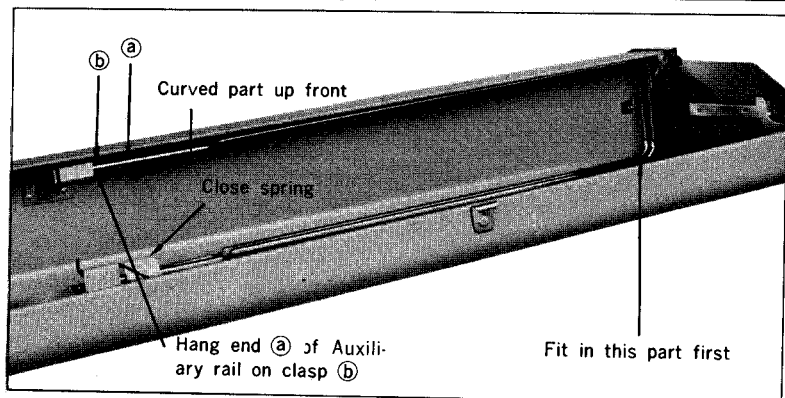
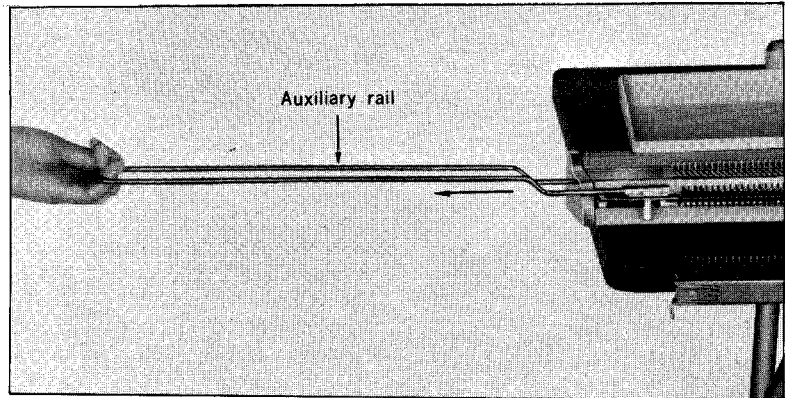

(5) Fold up the automatic yarn tension unit. Remove the automatic yarn tension unit.

(3) Replace the automatic yarn tension unit as shown in figure. (Fit the head A of automatic yarn tension unit under the clasp B of the case.)

(4) Place the yarn tension rod and the take-up spring beside comb and put them inside of hook C. And place the sinker plate as shown in figure.

FOR MODELS 585 & 588 ONLY

(9) Remove handle from the 'L' carriage and replace the 'L' carriage as shown in figure.

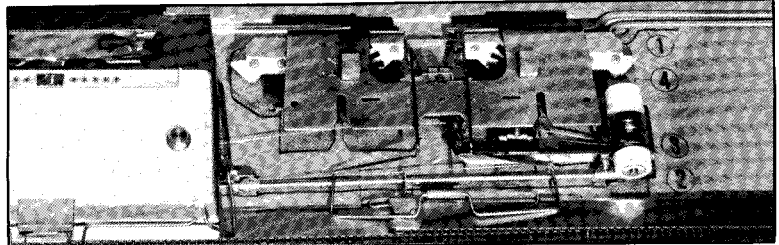
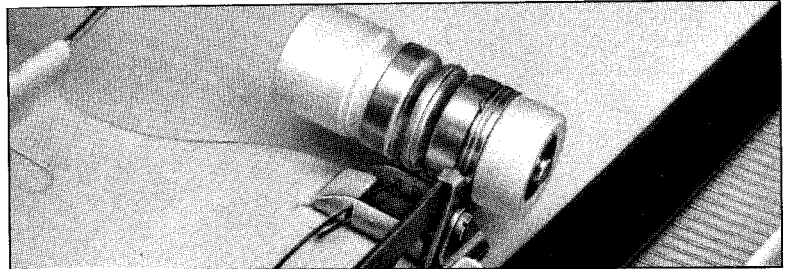
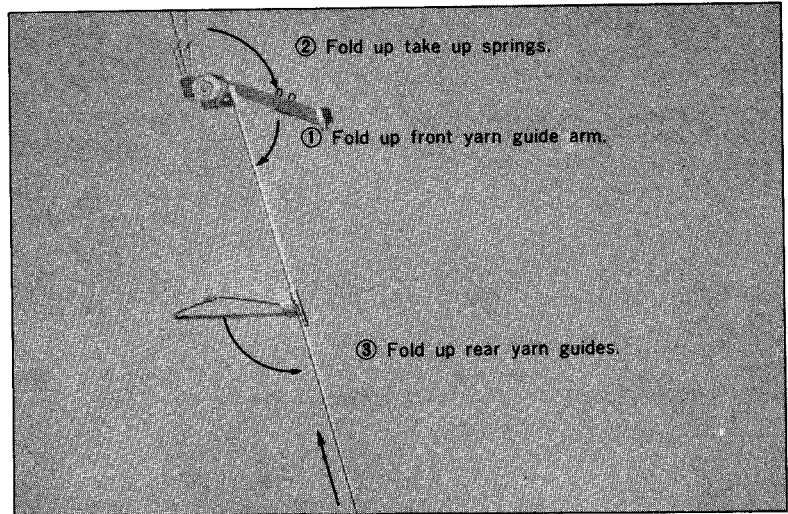

(10) Close the springs.

FOR ALL MODELS

(5) Remove the set lever, push down the release button, set the reverse lever to + and push back all needles to position 'A'.

(6) Take out the carriage lock from the accessories box and lock carriage on the left end of the needle bed.

(7) Pull out the row counter.

(8) Remove the accessory tray by sliding as indicated by arrows.

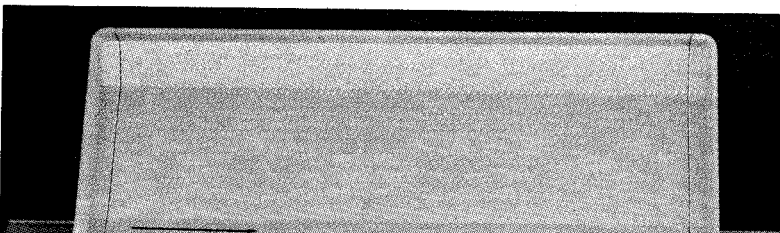
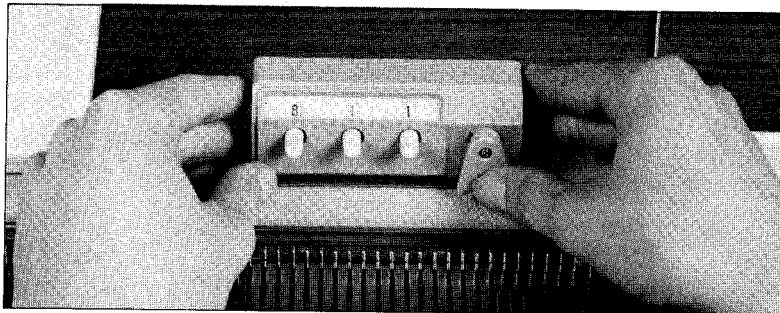
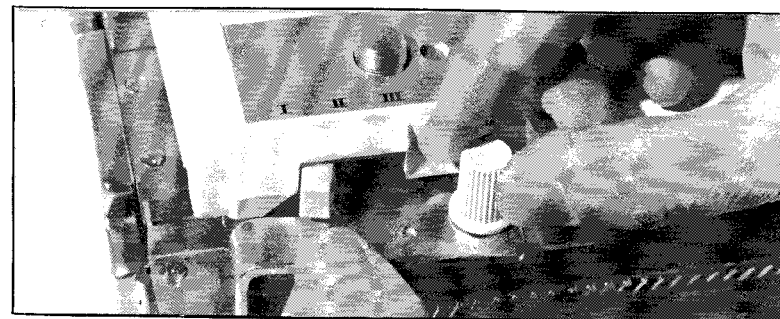
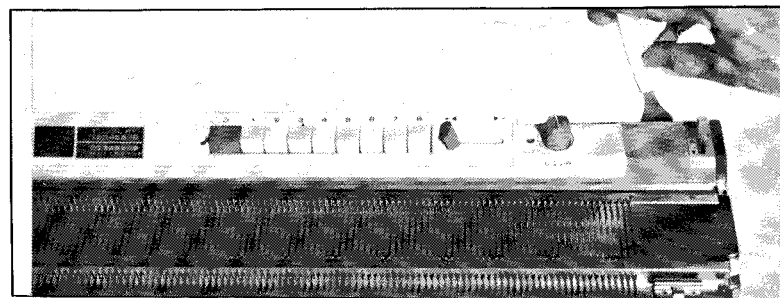
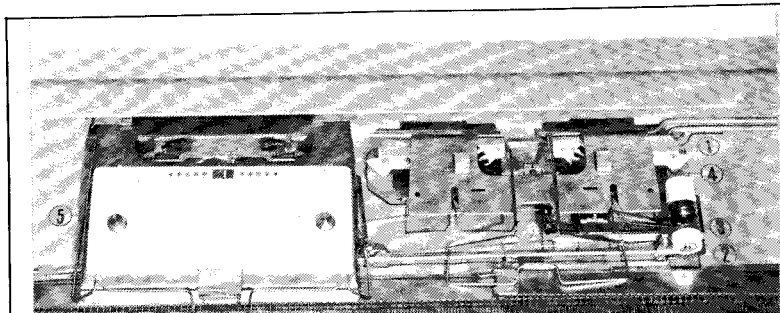

(15) Remove the handle of the carriage, table clamps and set lever. Replace them and other accessories in the accessories box.

(a) Place the box on the right side of the needle bed. The left end of the accessories box must be in line with the number 40 needle.

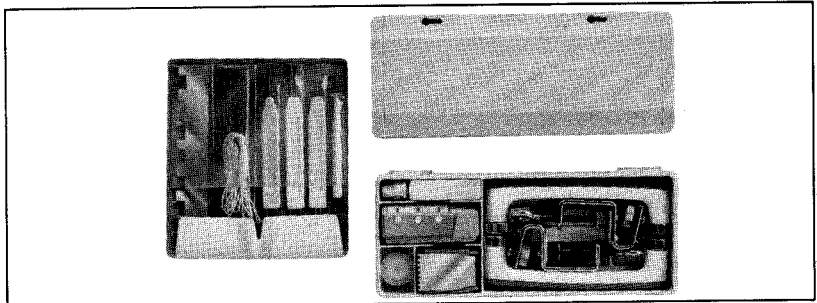

(11) Now the carriage is in left side and part box is in right side of the needle bed as shown in figure.

(b) Close the carrying case. Lock the two catches.

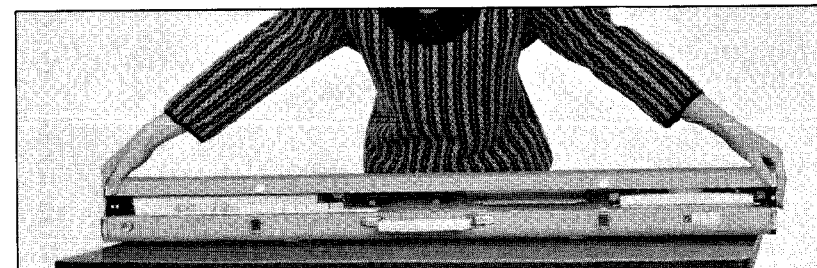
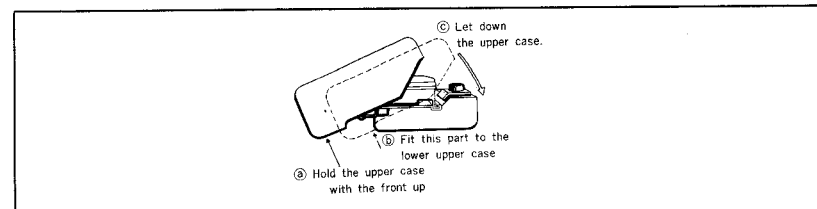
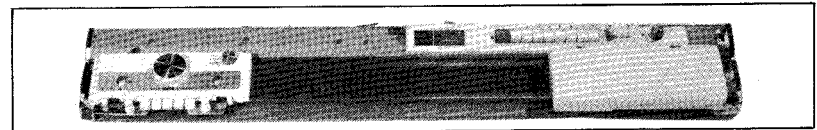
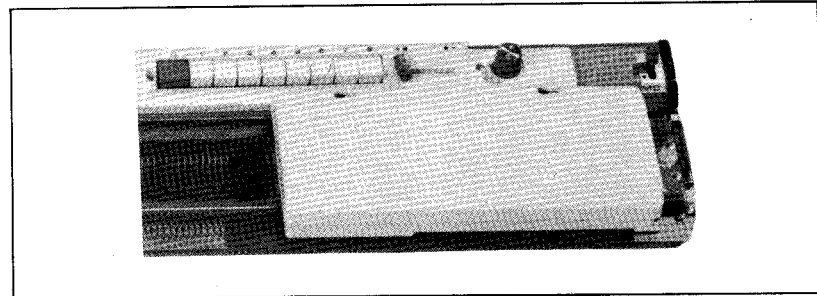
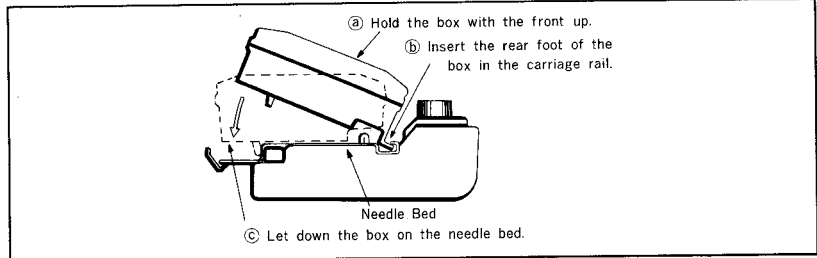

Questions and answers

64

HOW DO I OBTAIN SERVICE FOR MY MACHINE ?

Read carefully the service leaflet which accompanies your machine and explains many minor adjustments which you can carry out yourself – and save having to be without the machine. It also explains where to take it for service.

WHERE CAN I PURCHASE PATTERNS ?

These are available from all Knitting Machine stockists, and knitting centres throughout the country. If unable to obtain patterns please write directly to Head Office, enclosing payment for the patterns you require, plus postage.

WHERE CAN I PURCHASE ACCESSORIES (E.G. WOOLWINDERS) ?

Either from your local stockist, or directly from Head Office.

HOW CAN I BE ADVISED OF THE LATEST PATTERNS AND ACCESSORIES AVAILABLE ?

Details of all the latest developments for machines are given in each issue of *Stitchin' Time*. There are a number of patterns in each issue, as well as articles on sewing-up and various aspects of the knitting machines.

Stitchin' Time is a magazine for sewing and knitting machine users full of patterns and helpful hints.

for a subscription form write to:–
Jones Sewing Machine Co. Ltd.
Britannia House,
964 High Road, Finchley,
London N12, England.

Stitchin' Time is produced by The Jones Sewing Machine Co. Ltd., in conjunction with Brother International.

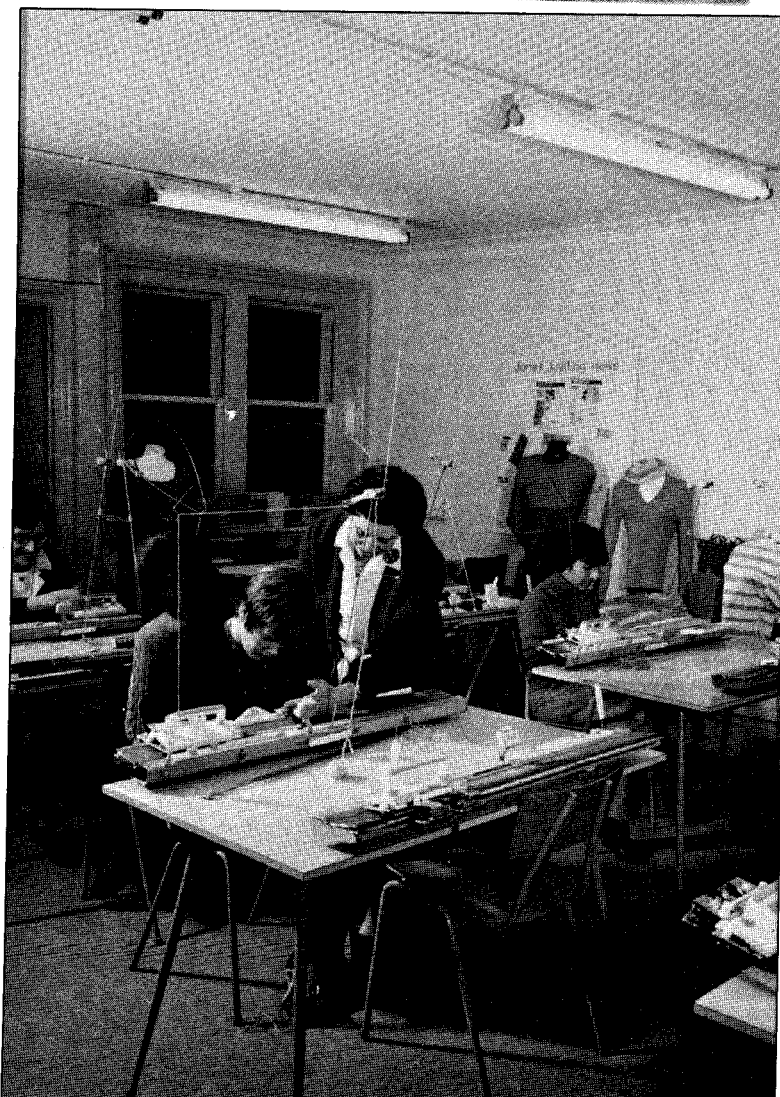
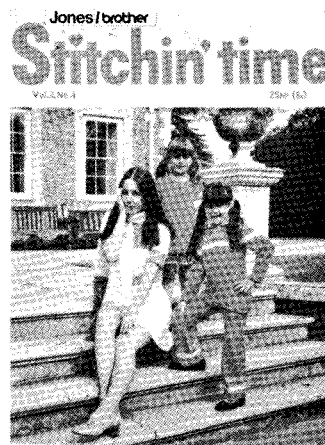

INDEX

- 2.....Parts name.
- 3.....Setting up your machine.
- 5.....Setting up the carriage.
- 7.....Assembling the yarn tension unit.
- 8.....Important points to remember before you start knitting.
 Winding the wool.
- 9.....Tension dial.
 Needle positions.
- 11.....Functions of the carriage.
- 13.....Preparing to knit.
- 18.....If the carriage should jam and how to unravel a row.
- 20.....Knitting a plain hem.
- 22.....Knitting an elastic hem.
- 23.....The finished "Double Rib".
 The completed 2 x 1 Rib.
- 24.....Casting—on.
- 25.....Knitting a picot hem.
 Picking up dropped stitches.
- 26.....How to use the transfer tool.
- 27.....Increasing stitches.
- 28.....Transferring to hand knitting needles.
- 29.....Decreasing stitches.
- 30.....Casting—off.
- 31.....Button—holes.
- 33.....How to knit a pocket.
- 34.....Shaping a "Vee" neck.
- 35.....Shaping a round neck.
 Shaping a square neck.
- 36.....Short row designing.
- 38.....How to use the pattern centre.
- 39.....Needle Selector Buttons, Reverse Lever & Slide Dial.
- 40.....Explanations of the pattern cards(charts).
- 43.....Fair—Isle pattern knitting.
- 44.....How to change the wool for two colour work.
- 45.....How to weave on your machine.
- 48.....Automatic lace patterns.
- 50.....Fitting the "L" carriage.
- 51.....How to read the pattern chart for lacy knitting.
- 53.....Maintenance.
- 54.....If the "L" carriage should jam.
- 56.....Replacing a bent or broken needle.
- 57.....Trying your first garment.
- 59.....Man's fully fashioned polo neck sweater.

