

HOW TO MASTER YOUR AUTOMATIC HOME KNITTER

KH 585

instruction manual **BROTHER-KNIT^{super}I**

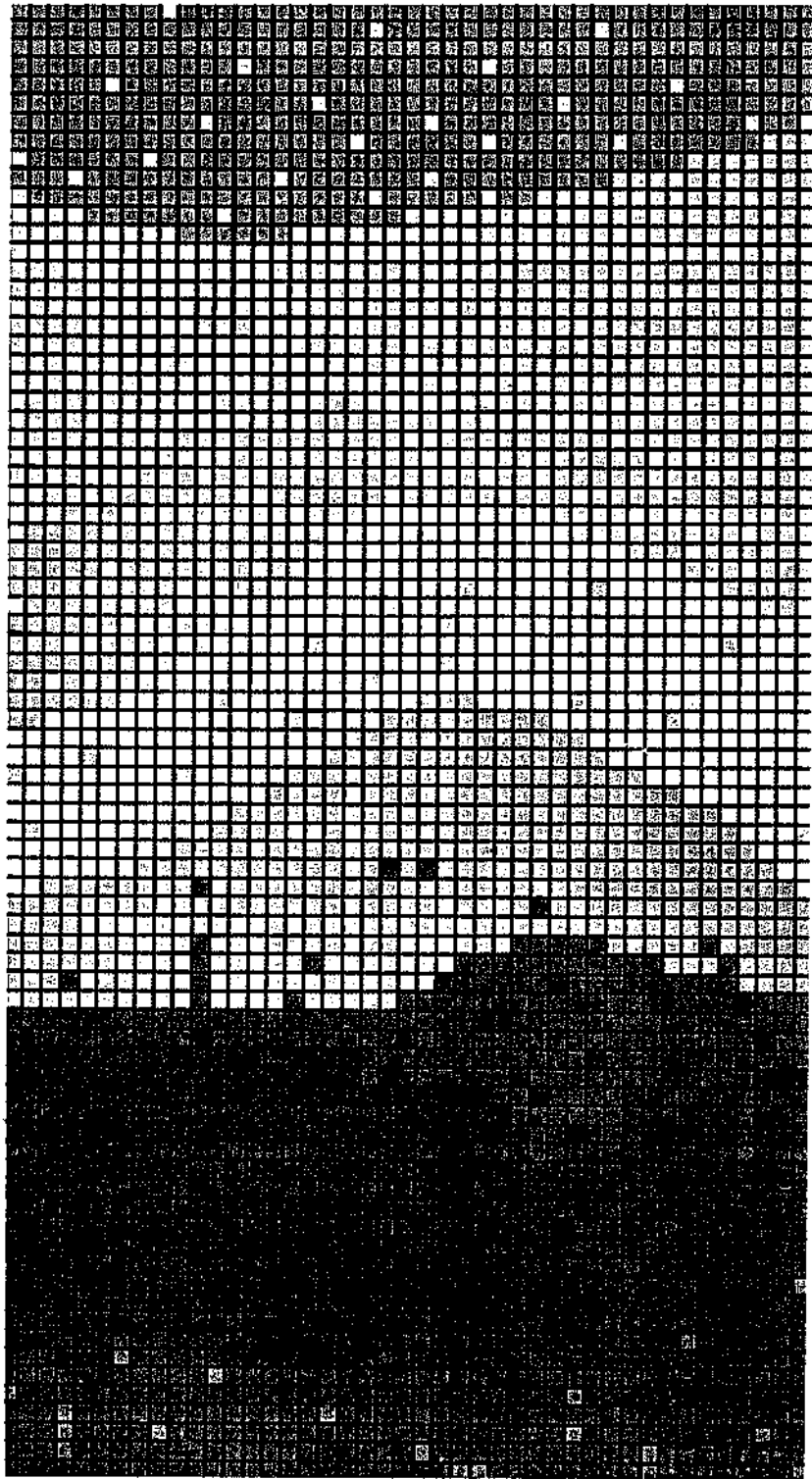

INDEX

SETTING UP THE KNITTER	1
INFORMATION BEFORE KNITTING	6
• Position of needles in the needle-bed	6
• Tension Dial	7
• Pattern Selector Buttons	7
• Holding cam levers	8
• Row-Counter	8
PREPARING TO KNIT	9
HOW TO USE THE PATTERN CENTER	16
• Needle Selection	16
• Needle Selector Buttons and Reverse Knob	17
• Slide Dial and Slide Indicator	18
HOW TO KNIT PATTERNS	19
1 Holding pattern (1)	21
2 Holding pattern (2)	23
3 Tucking pattern	24
4 Whole tucking pattern	25
5 Holding and Tucking pattern	26
6 Lace like pattern	27
7 Fair Isle pattern (1)	29
8 Fair Isle pattern (2)	30
9 Zigzag pattern	31
10 Colored zigzag pattern	32
11 Laying-in pattern (1)	35
12 " " (2)	36
13 " " (3)	36
14 " " (4)	37
15 Tube knitting	38
16 Cable stitch pattern	39
17 Ribbing stitch	41
18 Garter stitch pattern	43
KNITTING LACE PATTERNS USING L. CARRIAGE	45
1 Preparing to knit	45
2 How to use L. Carriage	46
3 How to knit Lace Pattern	49
Lace Pattern (1)	50
" (2)	51
" (3)	52
" (4)	53
HOW TO KNIT GARMENTS	51
1 Partial knitting in plain stitch	51
2 Partial knitting of holding stitch pattern	57
3 Partial knitting of tucking stitch pattern	61
4 Increasing stitch	61
5 Decreasing stitch	65
6 How to bind off	67
7 How to cast off	67
8 How to bind off one knit one-purl	67
9 Waste knitting	68
10 How to determine the gauge	68
11 Partial knitting with the L. carriage	69
Troubles and remedies	71
When the needle is bent	71
When the carriage is jammed	73
When the L. carriage is jammed	75
Care of your knitting machine	76
Oiling and Cleaning	76
Folding up the knitter	78

Carrying Case

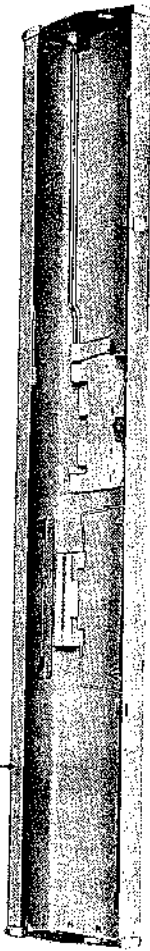

Accessory Tray (Cover of Accessory Box)

Row counter

Auxiliary rail nut

"L" Carriage

Gate Pegs

Needles

Carriage Handle

Tension Dial

Row Counter Tripper

Plastic Thumb Screw

Sinker Plate Arm

Laying-in Pattern Brush

Yarn Feeder

Knob for Laying-in Pattern Brush

Pattern Selector Buttons

Holding Cam Lever

Laying-in Pattern Lever

Carriage Dial

Needle Bed Upper Plate

Felt Bar

Slide Indicator

Slide Selector Buttons

Reverse Lever

Slide Dial

Set Lever

Pattern Center

Hook

Latch

Stem

Built Shank

When you set the ribbing attachment, remove auxiliary rail fastener.

Automatic Yarn Tension Unit

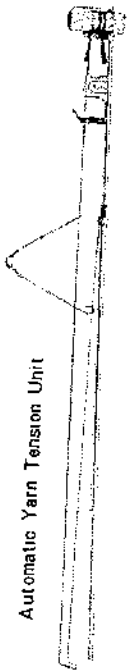

Auxiliary Rail



Paraffin



Sinker Plate Assembly



Cast-on Comb

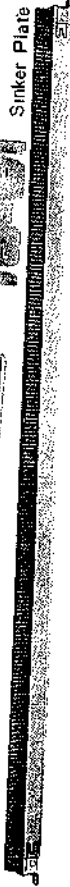

Set Lever



Hand Brush

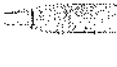

2 X 3 Transfer Tool



1 X 3 Transfer Tool



1 X 2 Transfer Tool



Crochet Needle



Latch Tool



Accessories Kit



1/2, 1/3 Needle Pusher



0 3/8 Needle Pusher



Spare Needles



Plastic Case for Spare Needles



Cast-on Thread



Oil Bottle



Row-Counter



Carriage Lock



Accessories Box

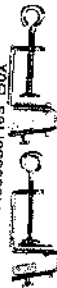

Table Clamps



Carriage Handles



SETTING UP THE KNITTER

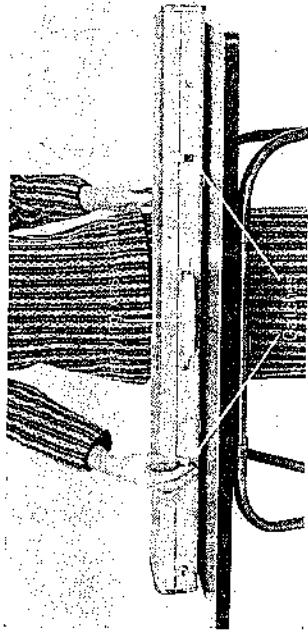
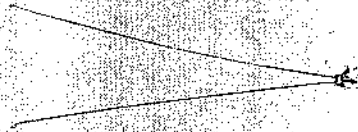

(1) Place the knitter with the handle of carrying case away from you and unlock the catches on both sides of the handle.

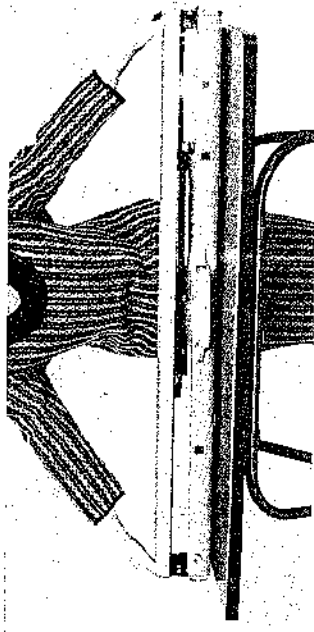

(2) Lift the upper case slightly and pull towards you, so that the upper case can be release.

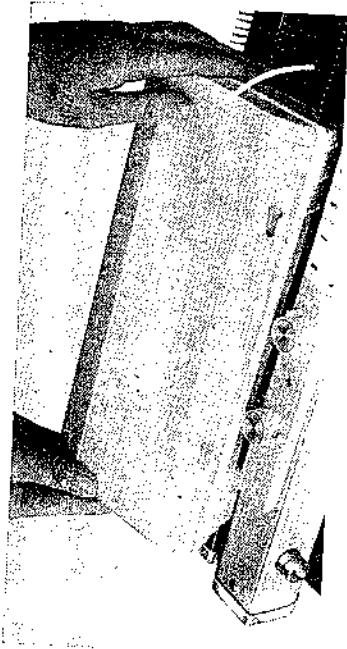

(3) Remove the accessories box on the needle bed.

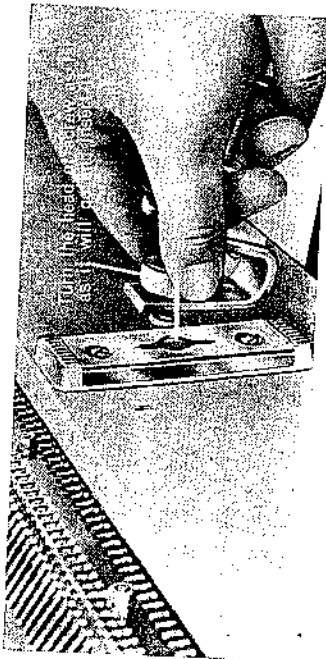

(4) Take the table clamps out of the accessories box. Raise the front of the knitter, insert the head of screw into the aperture.

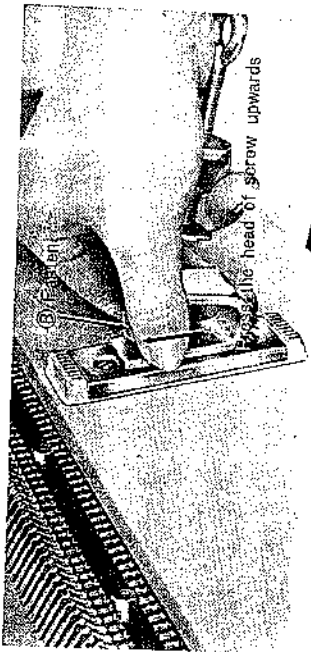

(5) Press the head of screw upwards and fasten the knob.

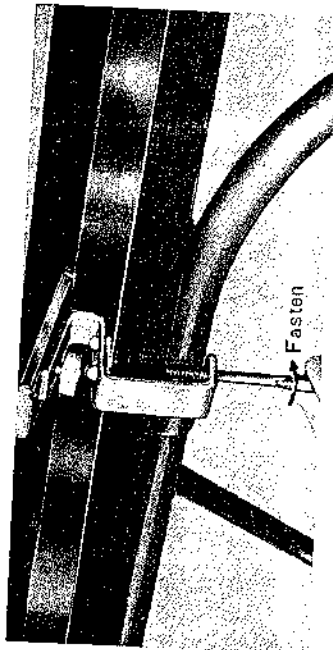

(6) Fasten the knitter to the table by tightening table clamp screws.

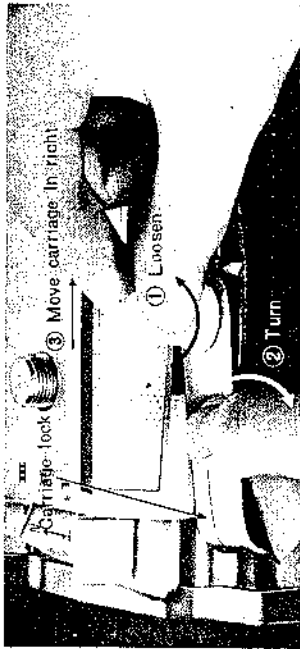

(7) Remove the carriage lock.

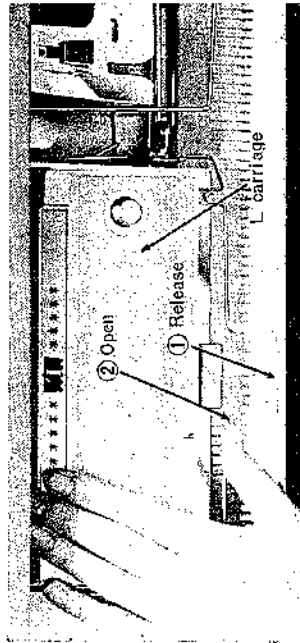

(8) Release the spring in the case and remove the L carriage.

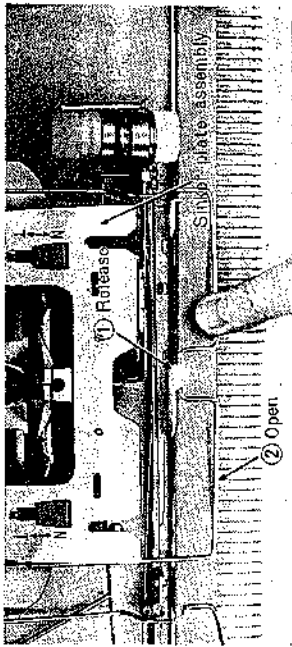

(9) Release the spring in the case and remove the sinker plate assembly.

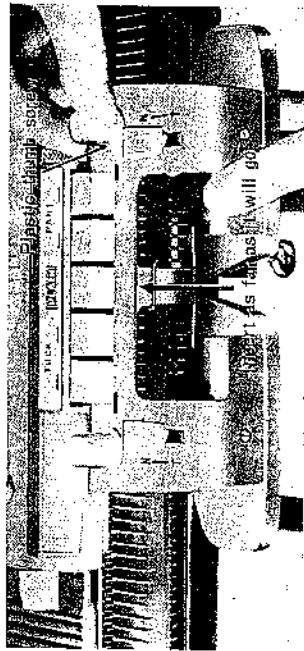

(10) Loosen the plastic thumb screws of carriage, insert the sinker plate assembly as far as it will go and fasten thumb screws securely.

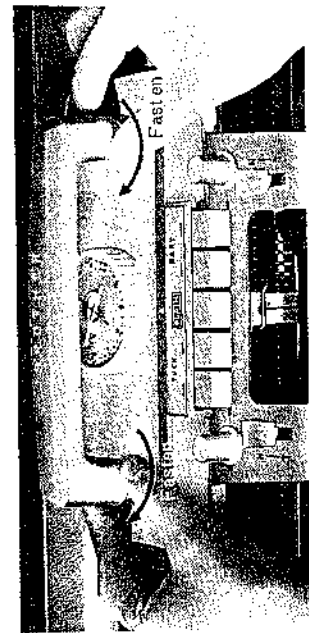

(1) Fasten the handle on the carriage.

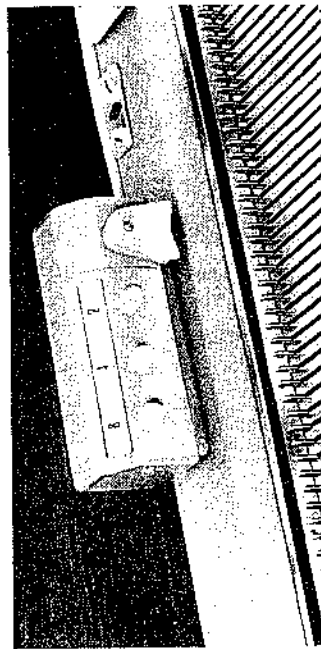

(2) Set the row counter on the row counter setting studs.
(Fit the studs in the apertures of row counter lower



plate, then slide the row counter away from you.)

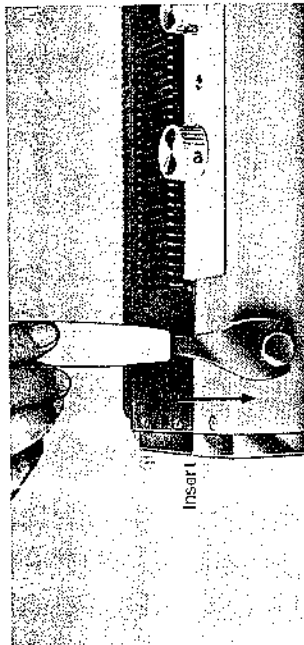

(3) Fit the set lever onto the shaft of the setter at the rear right of the needle bed.

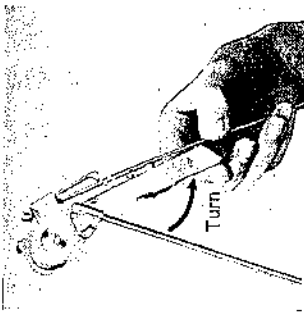

(6) Take out the automatic yarn tension unit from the case and turn the front yarn guide arm in the direction of the red arrow.

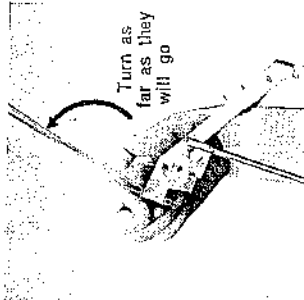

(6) Turn the take up springs as far as they will go.

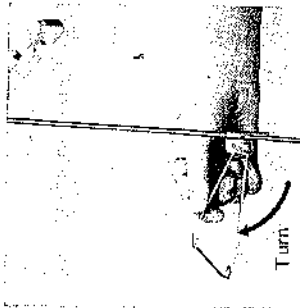

(6) Turn out the rear yarn guide as far as it will go.



(7) Fit the end of the rod into the stand hole at the center of knitter with the rear yarn guide away from you.



(8) Set the accessory tray (the cover of accessory box) on the accessory tray setting studs. (Insert the studs in the openings of the accessory tray and slide it to the left as it will go.)

INFORMATION BEFORE KNITTING

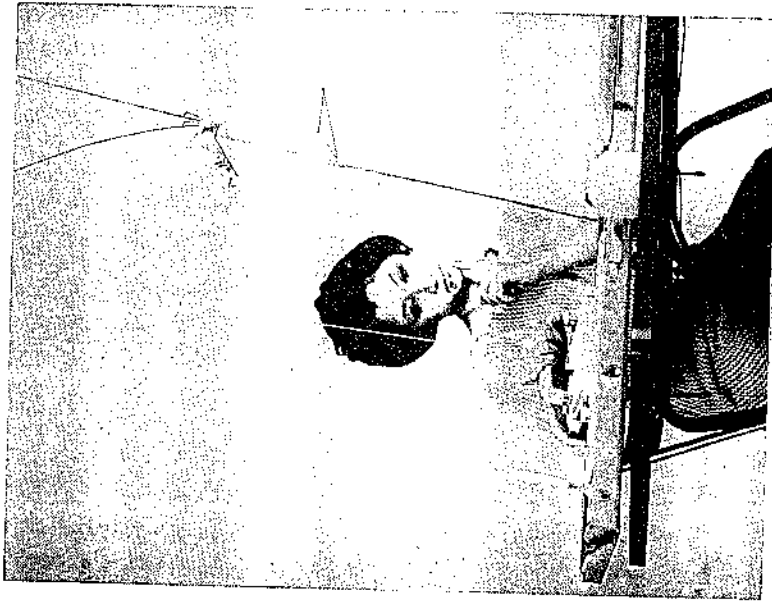

Positions of needles in the needle bed.

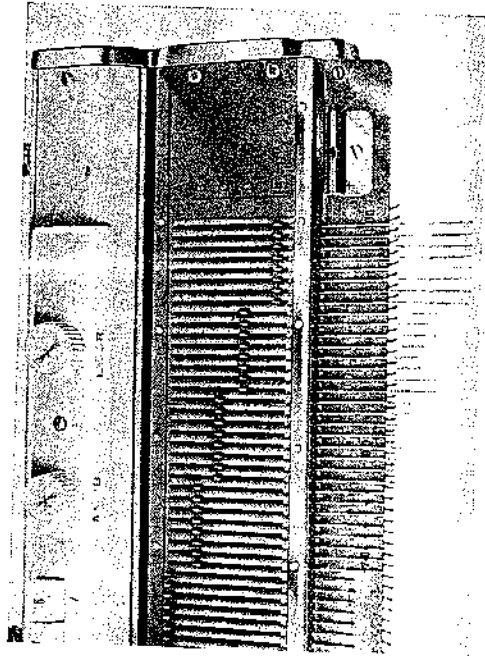

On the both sides of needle bed, there are marks A, B, C, D and E. These marks show the positions of needles.

• Tension Dial

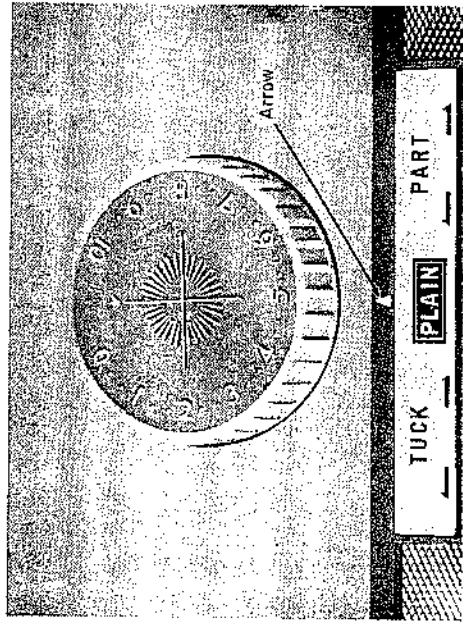

Tension in knitting denotes the size of the stitch. The tension dial is graduated from 0 to 10, each space between numbers being subdivided into three parts. The figure 0 denotes the tightest tension, i. e. the smallest stitch and the 10, the loosest or largest stitch. The tension at which a garment is knitted depends not only on personal taste, but also on the type of garment required and the thickness of the yarn.

• Pattern Selector Buttons

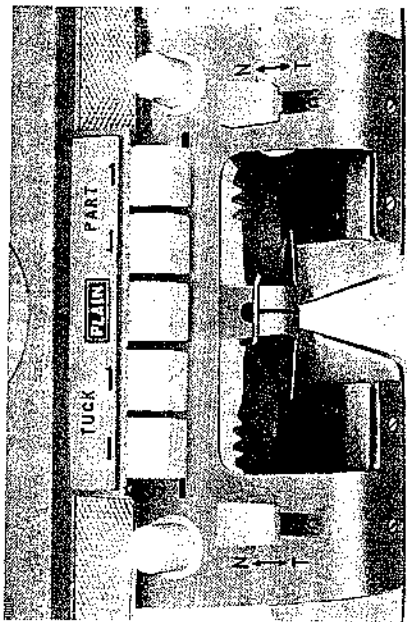

The center button marked "Plain", when pushed in, releases other buttons. When all five are even, you get plain knitting (stockinette stitch).

• Holding cam levers

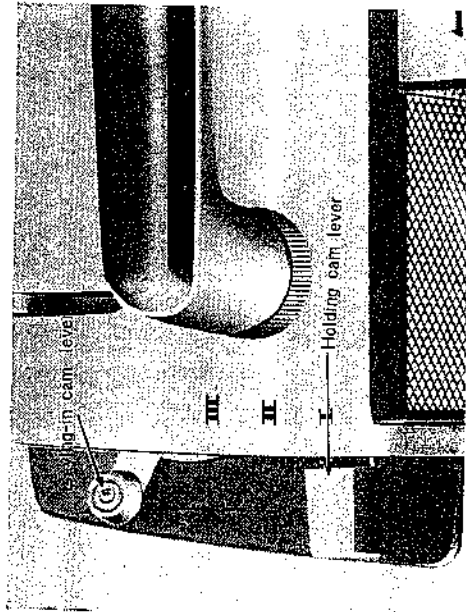

Holding cam levers have three positions: I, II and III.

- III Holding pattern knitting
- II Partial knitting
- I All other knitting than holding and partial knitting

Notes When laying-in cam levers are positioned in "I", holding cam levers can not be set in position "III".

• Row Counter

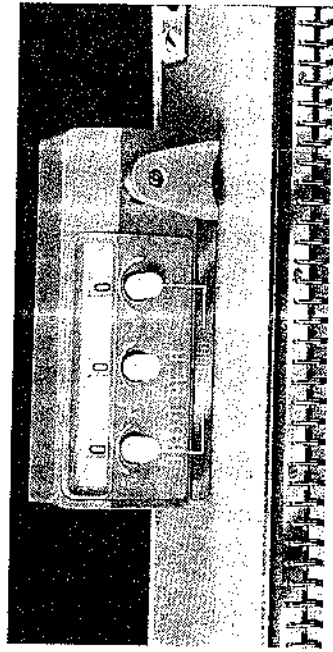

• You can turn the figures on the row counter to zero by turning as indicated by arrows, the 3 knobs in order from right.

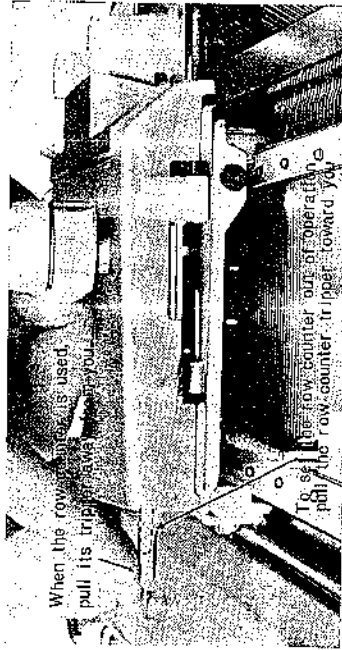

PREPARING TO KNIT

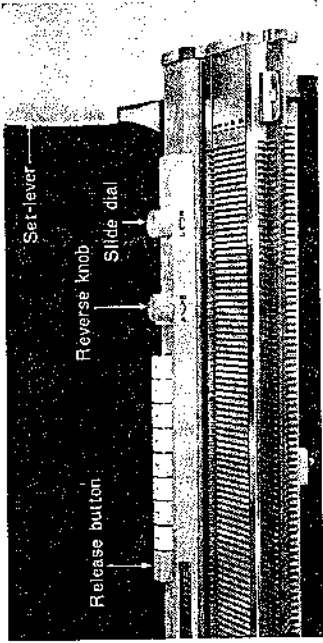
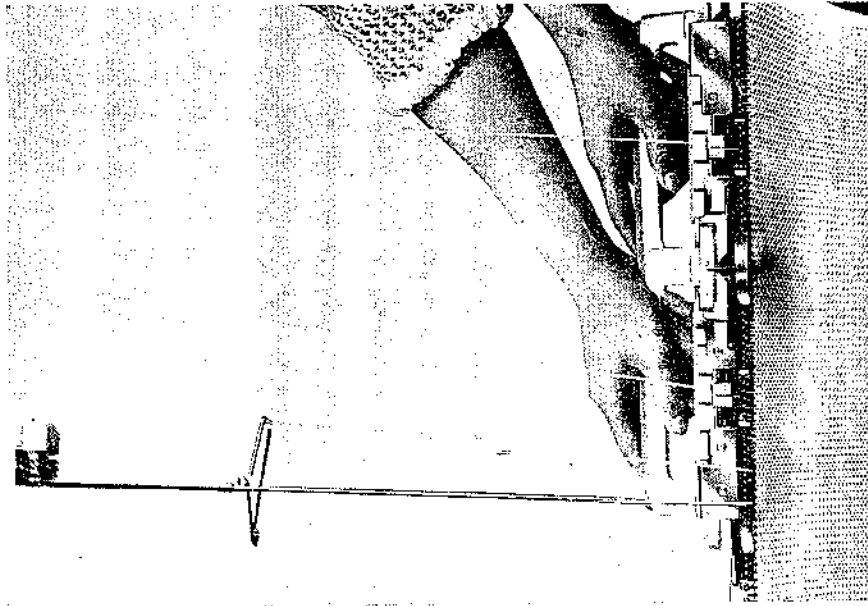

(1) Push down the release button and set the reverse knob to "A" and push back all needles to position "A".

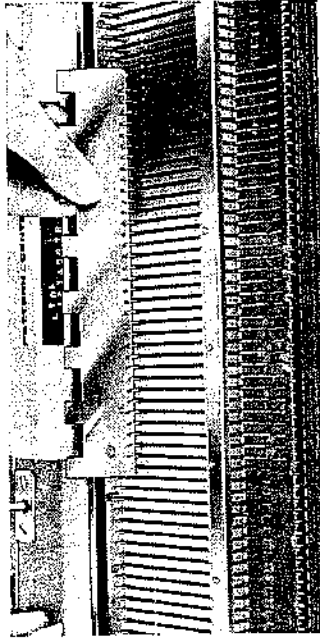

(2) Using the straight edge of a needle pusher, bring forward the desired number of needles to position "B", or about 1/2 from the resting position "A".

(3) Set the carriage as follows.

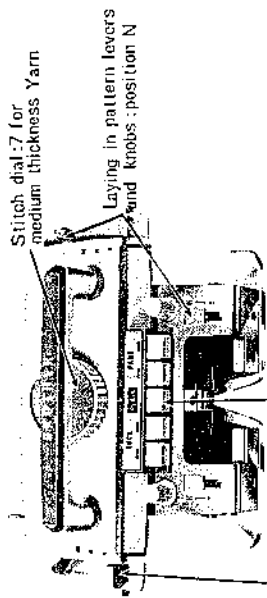

Pattern Selector Buttons : Plain Knitting

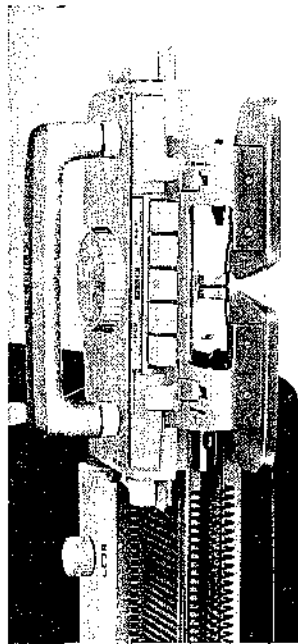

(4) Move the carriage across the working needles and put the carriage on the right end of the needle bed.

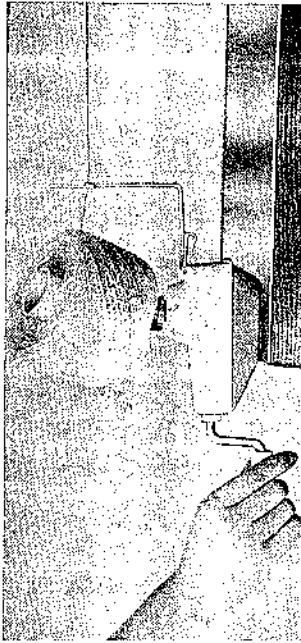

(5) Preparing the yarn

Method ①: Prepare the yarn by piling it loosely into a box or tray in order to prevent the knitting from being uneven.

Method ②: Wind the yarn to in ball with "Ball Winder" and "Stein Holder."

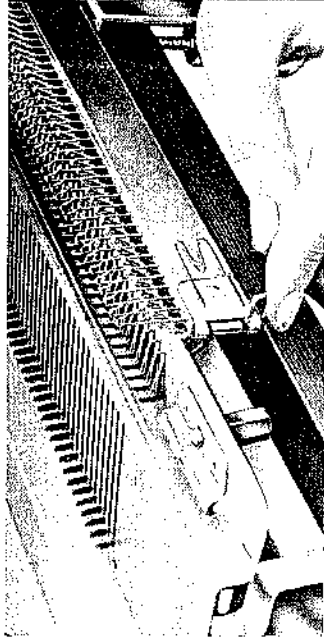

(6) Hold comb centered to the edge of the needle bed with the wire hooks of the comb facing you. Turn securing levers at both ends to face you.

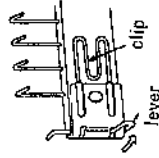

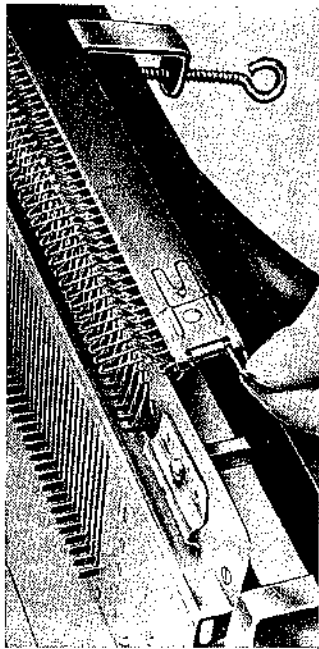

(7) Place hooks between pegs of needle bed as far as possible. Turn the two securing levers outwards to the right and left respectively, and cast-on comb will hang correctly on the machine.

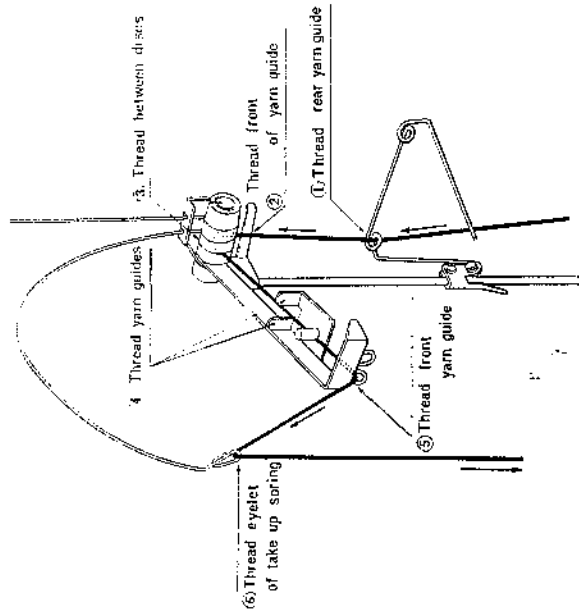
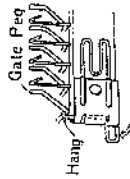

(8) Thread the automatic yarn tension unit

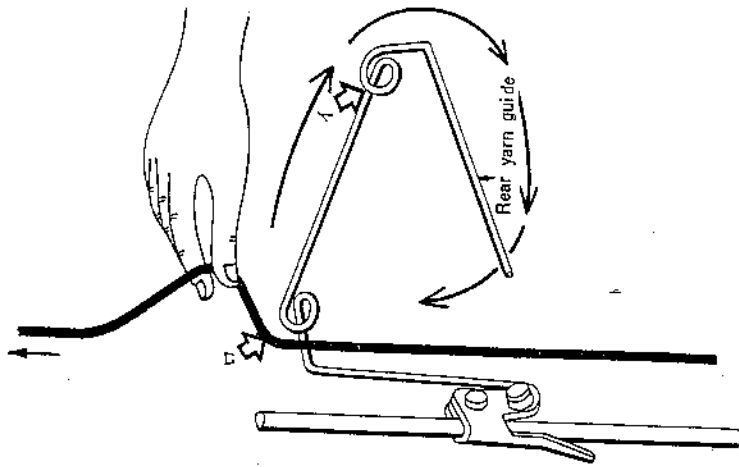

«How to thread the rear yarn guide»

When you use 2 ply yarn or lace yarn, fit paraffin to stud on front yarn guide.

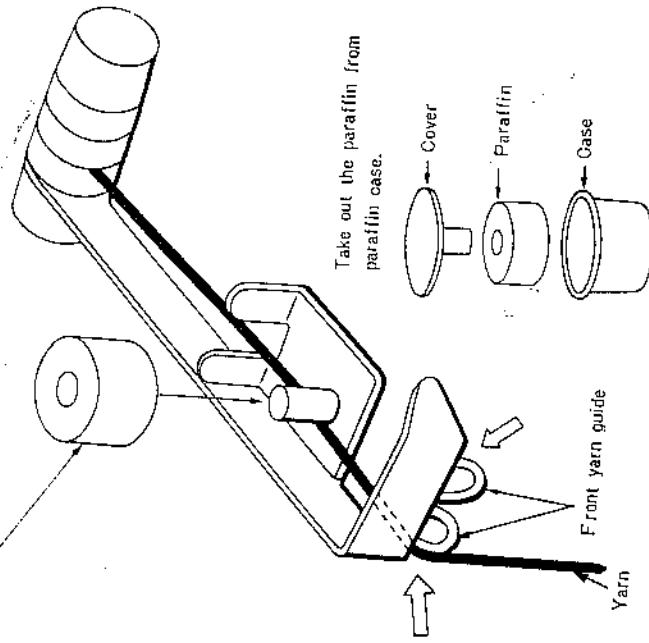

«How to thread the front yarn guide»

Thread the yarn through front yarn guide as shown in figure.

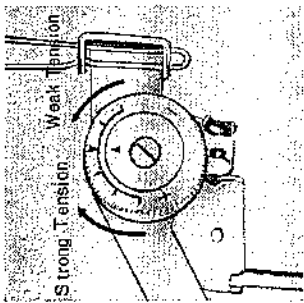

(9) Adjust the locating knob. The locating knob has marks "4" and "2". "1" denotes strong tension and "2" weak tension. Strong tension is suitable to thin yarn and weak tension is suitable to thick yarn.

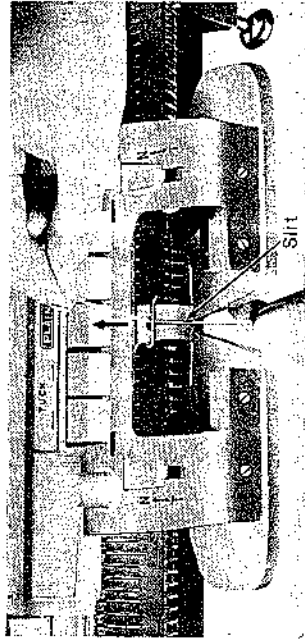

(11) Pull yarn back into slit until you hear the click of the yarn feeder spring.

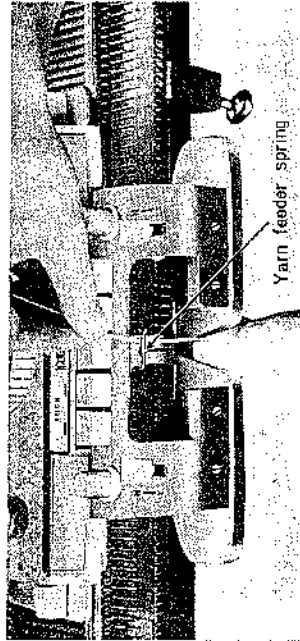

(10) Thread yarn under the yarn feeder spring.

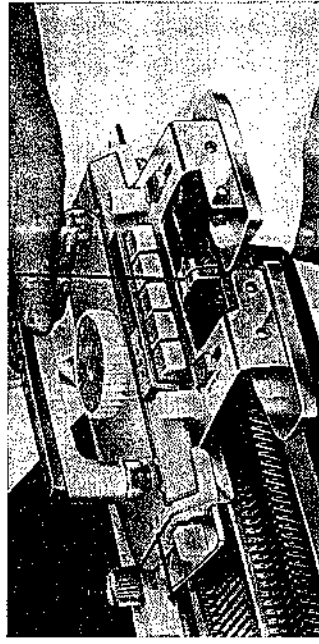

(12) Hold the end of yarn and move the threaded carriage from right to left. This will cause loops to be picked up in the needle hooks.

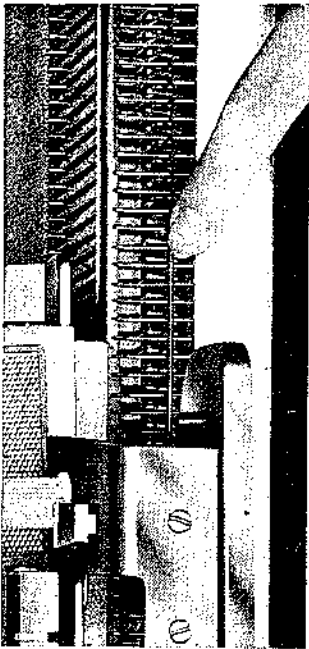

(6) If the last few needles come up from the line of other threaded needles, push them back with fingers. Continue the carriage movement until the carriage is clear of the cast-on comb.

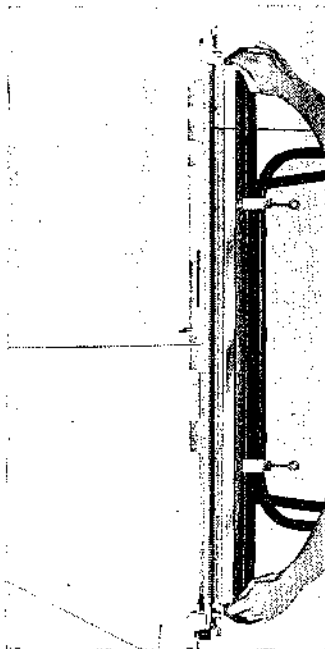

(7) Carefully unhook the comb from the pegs by turning the securing levers of the cast-on comb and let the cast-on comb hang in the loops of yarn.

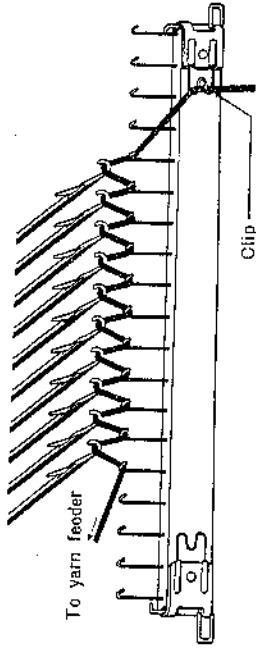

(8) Turn the loose end of the yarn round the cast-on comb clip to keep it out of the way and to secure the first stitch.

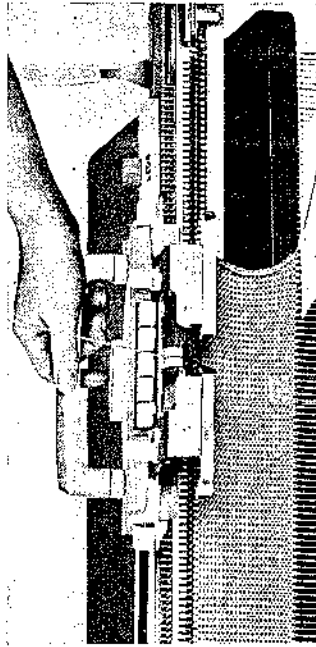

(9) After casting on, set the stitch dial to 5 for a medium thick yarn. Move the carriage from left to right and continue knitting. Move the carriage at an even speed and listen for a click at the end of each row.

If the carriage is jammed in the course of normal knitting, see page 73.

• Knit Stitch and Purl Stitch

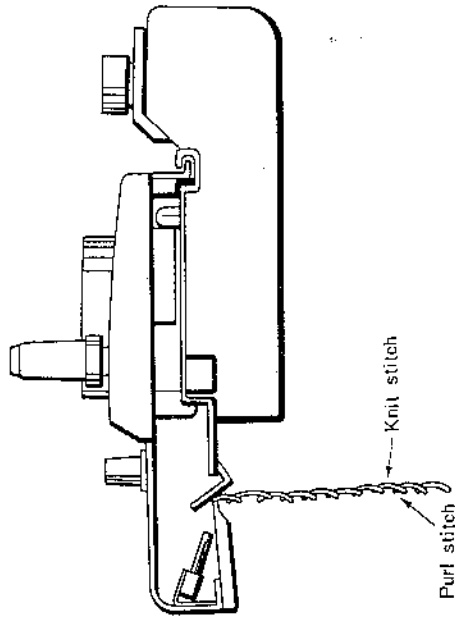

* In knitting, that side of the material which faces you is called the purl stitch, and the other side is called the knit stitch.

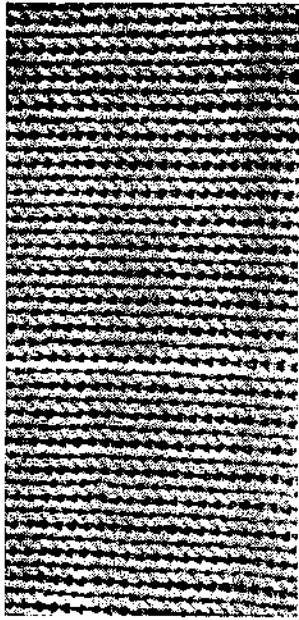

◀◀ Knit stitch of plain knitting ▶▶

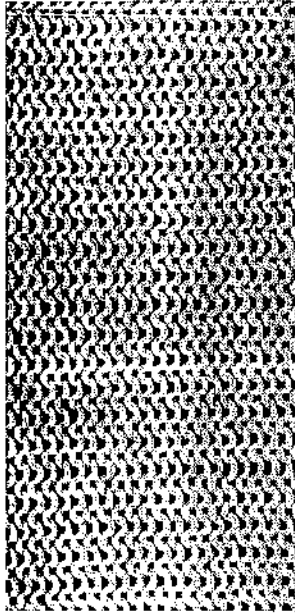

◀◀ Purl stitch of plain knitting ▶▶

HOW TO USE THE PATTERN CENTER

The pushbutton patterning system is one of the revolutionary features of this knitter. Multicolor and textured designs now can be made automatically and the pushbuttons in conjunction with the pattern selector button and the holding cams can produce most intricate designs effortlessly.

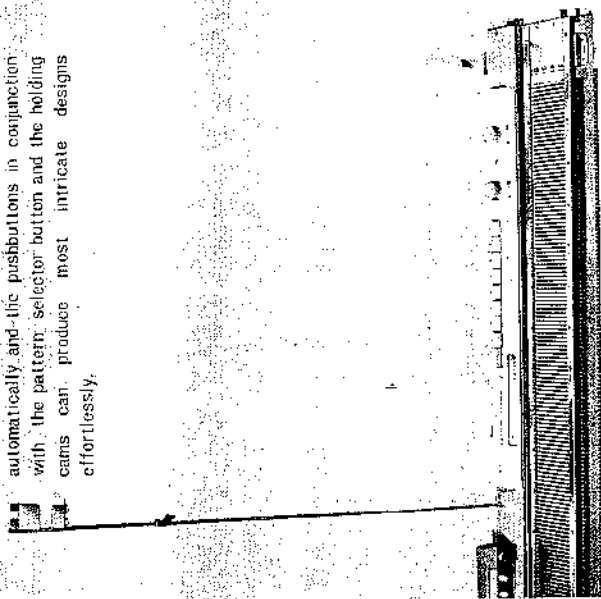

• Needle Selection

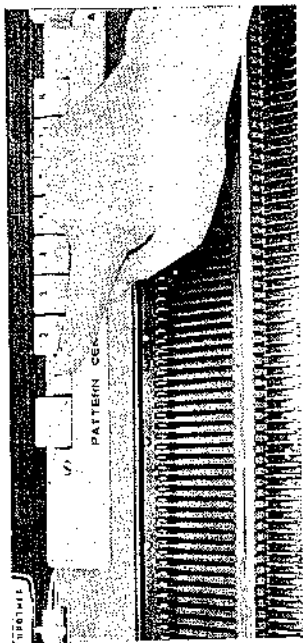

(1) Raise the desired number of needles from position "A" to position "B".

(2) Push down the "I" button.

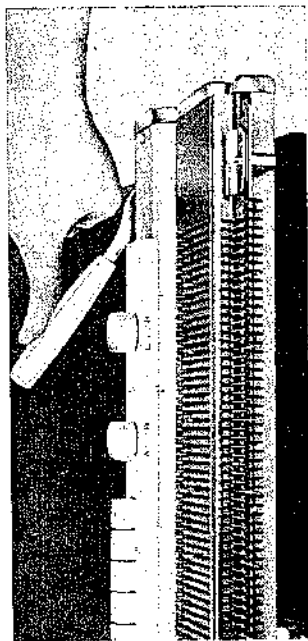

(3) Turn the set-lever to the left as far as it will go, then the corresponding needles will be raised to position "D".

(4) Move the carriage with setting for plain knitting. Then all needles will be back to position "B".

(5) Turn the set lever again so the same needle's group will be raised.

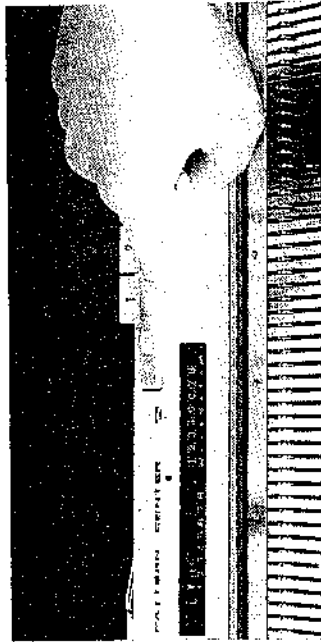

(6) Push down the release button, then the button "P" will be released.

• Needle Selector Buttons and Reverse Knob

* There are eight needle selector buttons. Each button controls each needle group. A combination of pushed down buttons will control the corresponding combination of selected needles.

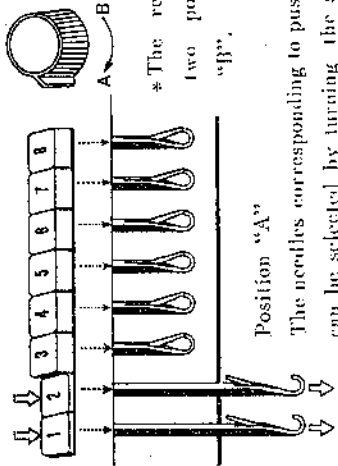

* The reverse knob has two positions "A" and "B".

Position "A"

The needles corresponding to pushed down buttons can be selected by turning the set lever.

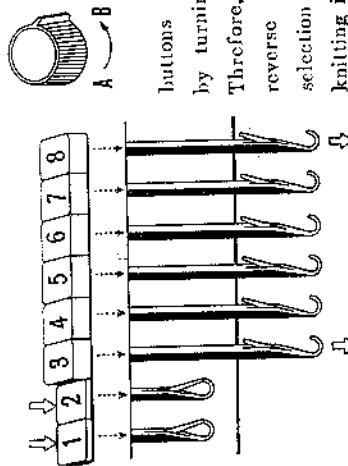

* Position "B"

The needles corresponding to unpushed down buttons can be selected by turning the set lever. Therefore, by using the reverse knob needle selection in multicolor knitting is very simple.

When the reverse knob is in position "B", you can see the figure "B" on the slide indicator.



• Slide dial and Slide Indicator

*The slide dial is used for sliding needle selection position and very useful for zigzag patterns and diagonal patterns.

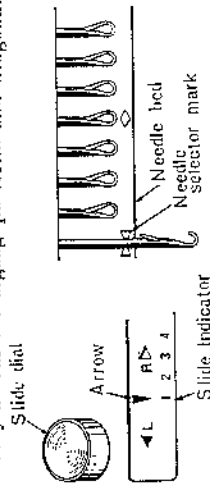

* (1) Push down the "1" button, turn the slide dial and set the arrow at 1 on the slide indicator.

Swivel the set lever, then the needles on the mark \times will be selected.

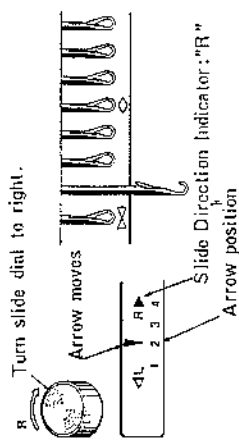

* (2) Turn the slide dial and set the arrow at 2 on the slide indicator.

Turn the set lever, then the needles on right side of the mark \times will be selected.

The slide direction indicator indicates the direction in which the slide dial is turned.

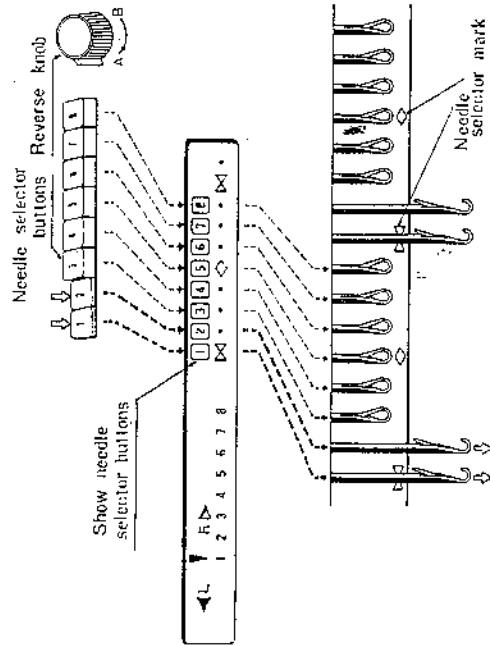

* (3) Relation between the needle selector buttons and the needles are shown in above figure.

HOW TO KNIT PATTERN KNITTING

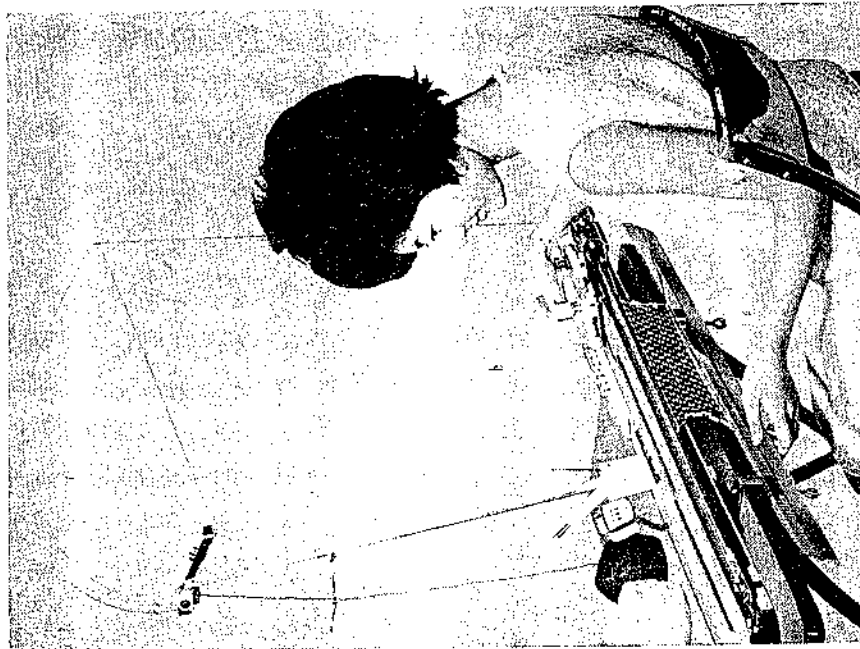

• How to read the pattern knitting tables

* Various knitting patterns are shown in the following pattern knitting tables.

The lower section of the table shows the operating parts of the knitter.

8	Laying-in Thread	Laying-in Pattern Apparatus	1	2	3	4	5	6	7	8
7			1	2	3	4	5	6	7	8
6			1	2	3	4	5	6	7	8
5			1	2	3	4	5	6	7	8
4			1	2	3	4	5	6	7	8
3			1	2	3	4	5	6	7	8
2			1	2	3	4	5	6	7	8
1			1	2	3	4	5	6	7	8

Needle Selector Reverse Knurl Buttons
 Pattern Center Slide Dial

Tension Dial

Color of Yarn

Direction of Carriage Movement

Steps

Carriage

- Steps:
 - Operate the knitter in numerical order.
 - The required operation in each step is shown in the lateral rows of the table.
- Direction of carriage movement:
 - Move the carriage according to the direction of arrow.
 - Before step 1, place the carriage on the right side of the needle bed.
- Color of yarn :
 - Shows the color of yarn in the yarn feeder.
 - Main Color: A
 - Sub Color: B, C,
 - Figure "O" means the movement of the carriage without knitting.
- Tension Dial:
 - Shows the tension No. of the Dial.
 - The numerals show tension for medium size yarn.
- Carriage:
 - Shows the setting of the pattern selector buttons and holding cam levers.

Needle Selector Buttons

[1]~[8] :

Shows the button to be pushed down and operation of the set lever.

- a) [5] means pushing down button "5" and operation of the set lever.
- b) [] means operation of the set lever without repushing down of button.

- Reverse Knob:
 - Shows the position of the reverse knob.

- Slide Dial:
 - Shows the number on slide indicator to which the arrow to be set.

- Laying-in parts:
 - Shows the position of the laying-in levers and knobs of the brush wheels.

- Laying in thread:
 - Shows the color of the laying-in thread.

1. Hodding Pattern (1)

Steps	1	2	3	4	5	6	7	8	9	10	11	12
Direction of Carriage Movement	→	→	→	→	→	→	→	→	→	→	→	→
Color of Yarn	A	5	III	→	→	→	→	→	→	→	→	→
Tension Dial	III	III	III	III	III	III	III	III	III	III	III	III
Carriage	1	2	3	4	5	6	7	8	9	10	11	12
Needle Selector Reverse Knob	1	2	3	4	5	6	7	8	9	10	11	12
Buttons	1	2	3	4	5	6	7	8	9	10	11	12
Pattern Center	1	2	3	4	5	6	7	8	9	10	11	12
Slide Dial	1	2	3	4	5	6	7	8	9	10	11	12
Legend in Pattern	A	5	III	→	→	→	→	→	→	→	→	→

This pattern can be knitted by operating the holding cam levers, slide dial and set lever.

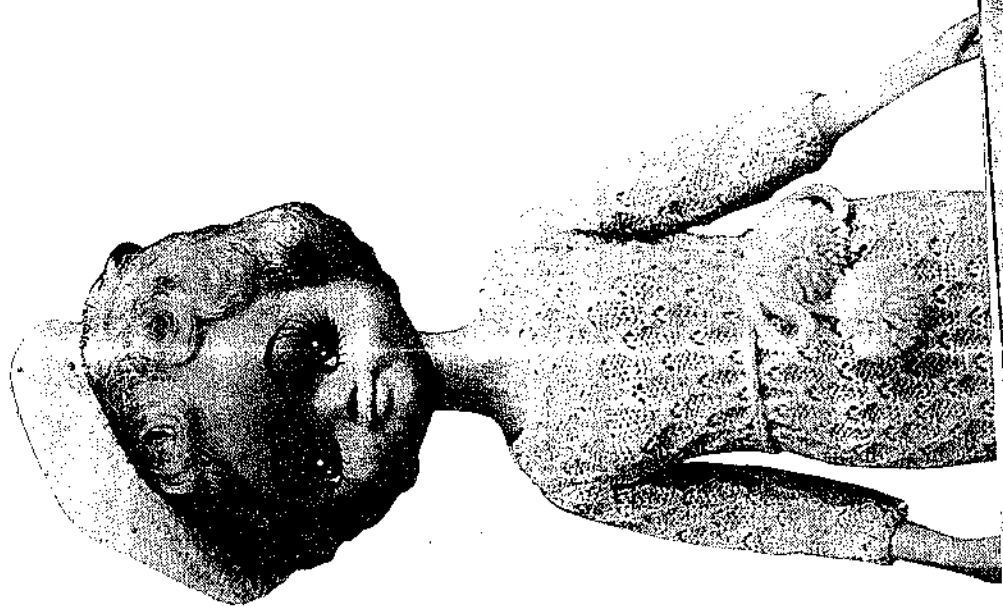

How to knit the holding pattern (1).

It is not necessary to change the yarn, pattern selector button and reverse knob. Knit several rows of plain knitting and rest the carriage on the right side of the needle bed apart from knitting.

Step 1.

color of yarn : main color
tension dial : 5
holding cam levers: left III, right III
pattern selector button: plain
needle selector button : 1,5
reverse knob : A
slide dial : 1

After setting as above, swivel set lever and move the carriage from right to left.

Step 2.

Move the carriage to right.

Step 3.

Move the carriage to left.

Step 4.

Move the carriage to right.

Step 5.

Change the left holding cam lever from "III" to "I", and move the carriage to left.

Step 6.

Move the carriage to right.

Step 7.

Turn the slide dial and set the arrow to 3 on the slide indicator.

Swivel the set lever.

Change the left holding cam lever from "I" to "III".

Move the carriage to left.

Step 8.

Move the carriage to right.

Step 9.

Move the carriage to left.

Step 10.

Move the carriage to right.

Step 11.

Change the left holding cam lever from "III" to "I", and move the carriage to left.

Step 12.

Move the carriage to right.

Repeat steps (1)~(12).

2. Holding Pattern (2)

Steps	Direction of Carriage Movement	Color of Yarn	Tension Dial	Carriage	Needle Selector	Recevier Knob	Buttons	Pattern Center	Slide Dial	Laying in Pattern Apparatus
12	→	→	→	→	→	→	→	→	→	→
11	→	→	→	→	→	→	→	→	→	→
10	→	→	→	→	→	→	→	→	→	→
9	→	→	→	→	→	→	→	→	→	→
8	→	→	→	→	→	→	→	→	→	→
7	→	→	→	→	→	→	→	→	→	→
6	→	→	→	→	→	→	→	→	→	→
5	→	→	→	→	→	→	→	→	→	→
4	→	→	→	→	→	→	→	→	→	→
3	→	→	→	→	→	→	→	→	→	→
2	→	→	→	→	→	→	→	→	→	→
1	→	→	→	→	→	→	→	→	→	→

* Leave the needles on the marks \boxtimes and \diamond in position "A".
Raise other needles to position "B".

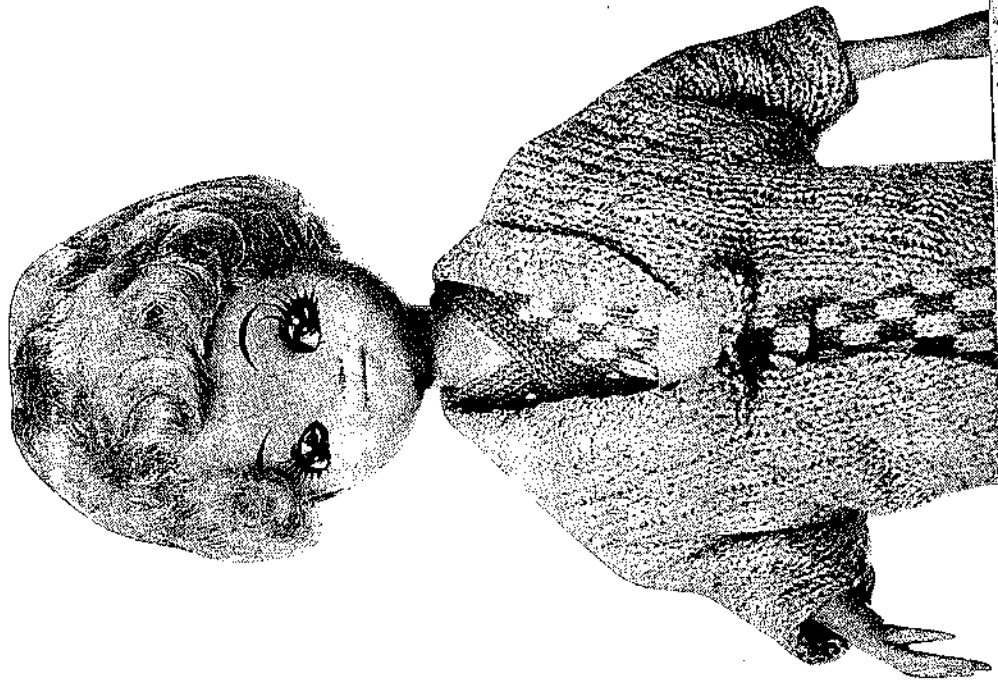

4. Whole tucking pattern

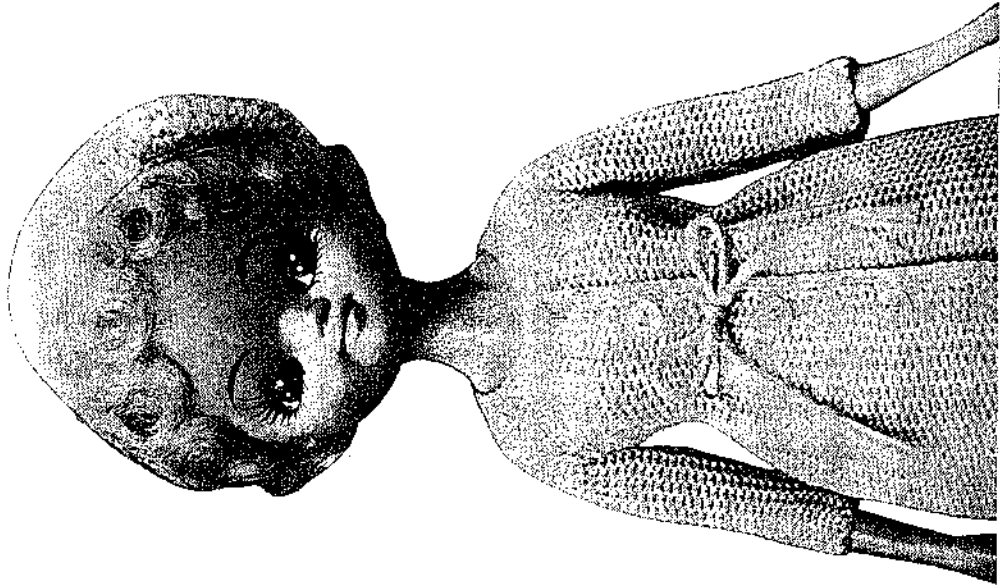
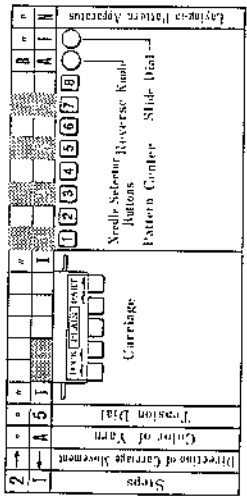

5. Holding and tucking pattern

Steps	Direction of Carriage Movement	Color of Yarn	Tension Dial	Carriage	Needle Selector	Reverse Knob	Bulkers	Pattern Counter	Slide Dial	Knit	Purl	Tuck	Open	Stitch
1	→	A	7	□	1	0	0	0	0	0	0	0	0	0
2	←	A	7	□	1	0	0	0	0	0	0	0	0	0

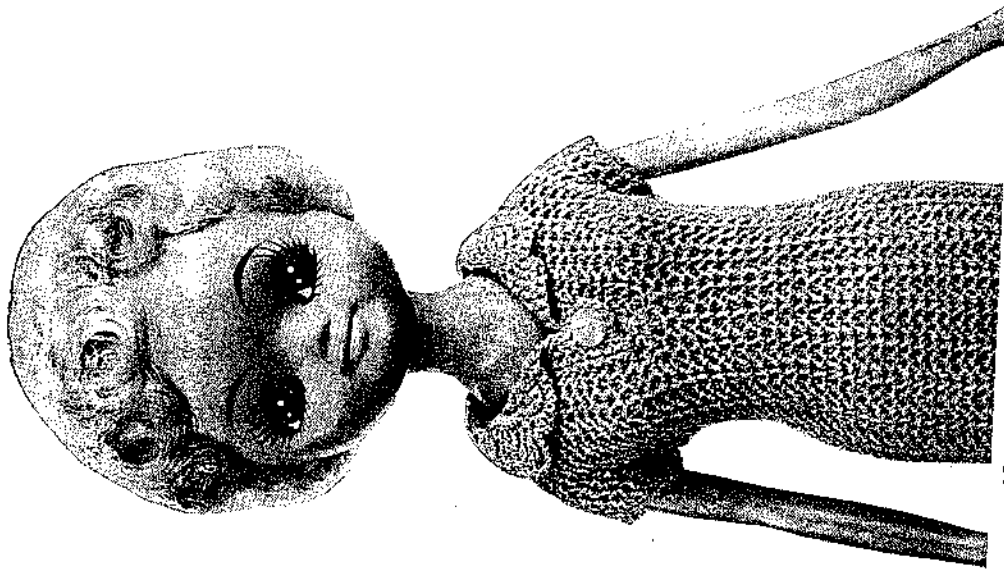

6. Lace-like pattern

Steps	Direction of Carriage Movement	Color of Yarn	Tension Dial	Carriage	Needle Selection	Reverse Knit	Stitch Dial	Layout in Pattern Apparatus
8	←	*	5	1	1		1	*
7	←	*	5	1	1		1	*
6	←	*	5	1	1		1	*
5	←	*	9	1	1		1	*
4	←	*	5	1	1		1	*
3	←	*	5	1	1		1	*
2	←	*	5	1	1		1	*
1	←	A	9	1	1		1	*

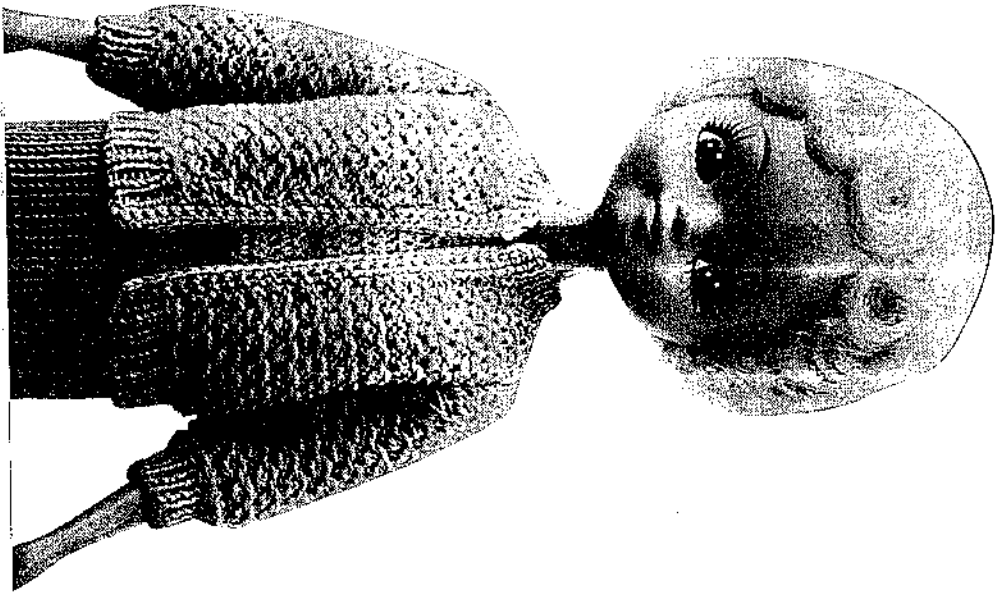

How to change the yarn for fair isle pattern

Thread two yarn in automatic yarn tension unit. Thread the knitting yarn through the yarn feeder and hold other yarn with the yarn clip.

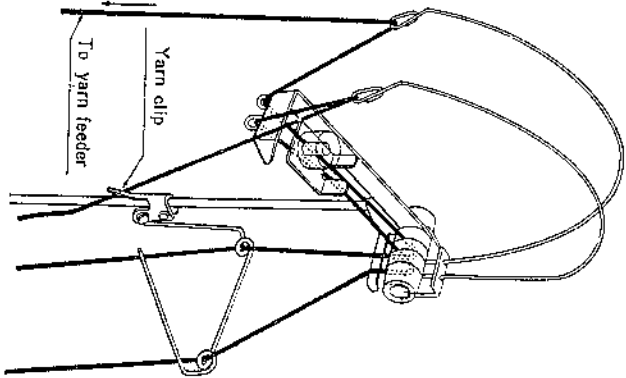

How to change the yarn.

Take off the yarn from yarn feeder and hang it on the end of needle bed.
Thread other yarn through the yarn feeder.

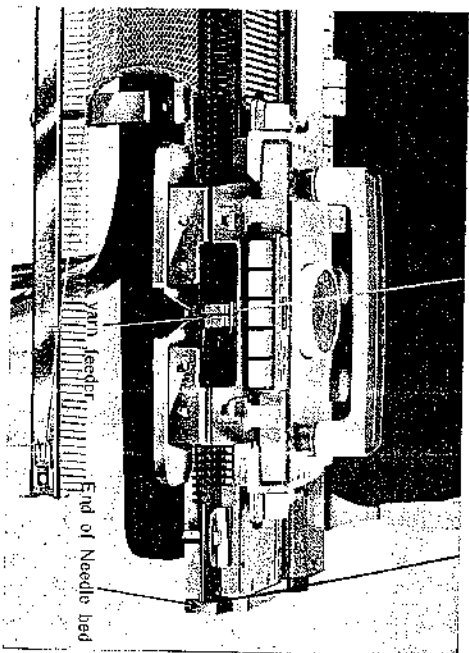

7. Fair Isle pattern (1)

7 Steps	16	15	14	13	12	11	10	9	8	7	6	5	4	3	2	1	16	15	14	13	12	11	10	9	8	7	6	5	4	3	2	1
Direction of Carriage Movement	→	→	→	→	→	→	→	→	→	→	→	→	→	→	→	→	←	←	←	←	←	←	←	←	←	←	←	←	←	←	←	
Color of Yarn	A	A	B	B	A	A	B	B	A	A	B	B	A	A	B	B	A	A	B	B	A	A	B	B	A	A	B	B	A	A	B	B
Tension Dial	7	7	7	7	7	7	7	7	7	7	7	7	7	7	7	7	1	1	1	1	1	1	1	1	1	1	1	1	1	1	1	1

Carriage	1	2	3	4	5	6	7	8	9	10	11	12	13	14	15	16

Needle Selection	1	2	3	4	5	6	7	8	9	10	11	12	13	14	15	16

Landscape Pattern Apparatus	1	2	3	4	5	6	7	8	9	10	11	12	13	14	15	16

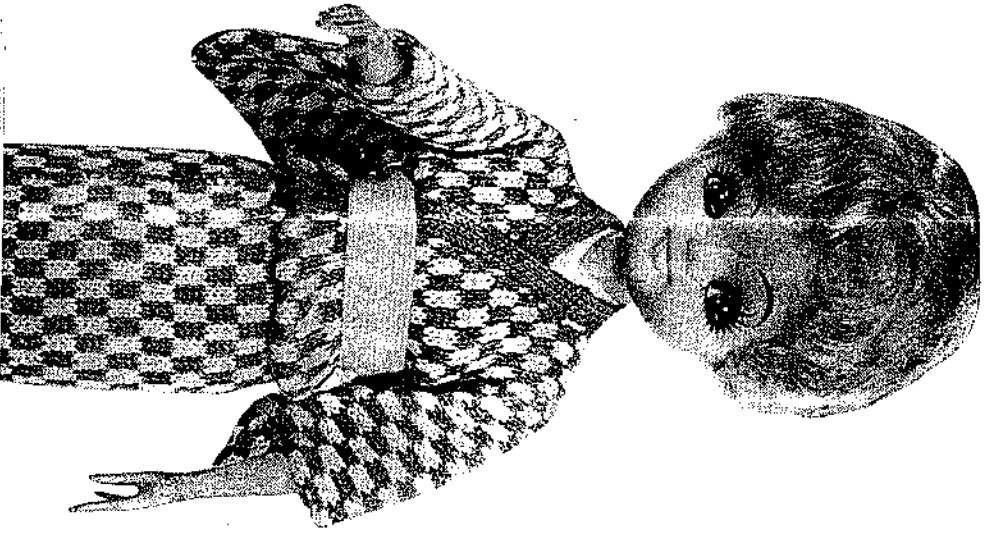

8. Fair Isle pattern (2)

Steps	Direction of Carriage Movement	Color of Yarn	Tension Dial	Carriage	Yards Selector Buttons	Reverse Knit Pattern Center Slide Dial	Lattice in Pattern Apparatus
24	→	○	*				*
23	→	A	*				*
22	→	B	*				*
21	→	○	*				*
20	→	A	*				*
19	→	B	*				*
18	→	○	*				*
17	→	A	*				*
16	→	B	*				*
15	→	○	*				*
14	→	A	*				*
13	→	B	*				*
12	→	○	*				*
11	→	A	*				*
10	→	B	*				*
9	→	○	*				*
8	→	A	*				*
7	→	B	*				*
6	→	○	*				*
5	→	A	*				*
4	→	B	*				*
3	→	○	*				*
2	→	A	*				*
1	→	B	*				*



9. Zigzag pattern

Steps	1	2	3	4	5	6	7	8	9	10	11	12	13	14
Direction of Carriage Movement	←	→	←	→	←	→	←	→	←	→	←	→	←	→
Color of Yarn	1	2	1	2	1	2	1	2	1	2	1	2	1	2
Tension Dial	7	1	7	1	7	1	7	1	7	1	7	1	7	1
Carriage	1	2	3	4	5	6	7	8	9	10	11	12	13	14
Needle Selection	1	2	3	4	5	6	7	8	9	10	11	12	13	14
Buttons														
Pattern Center														
Slide Dial														
Laying-in Pattern Apparatus	A	1	1	2	2	3	3	4	4	5	5	6	6	7

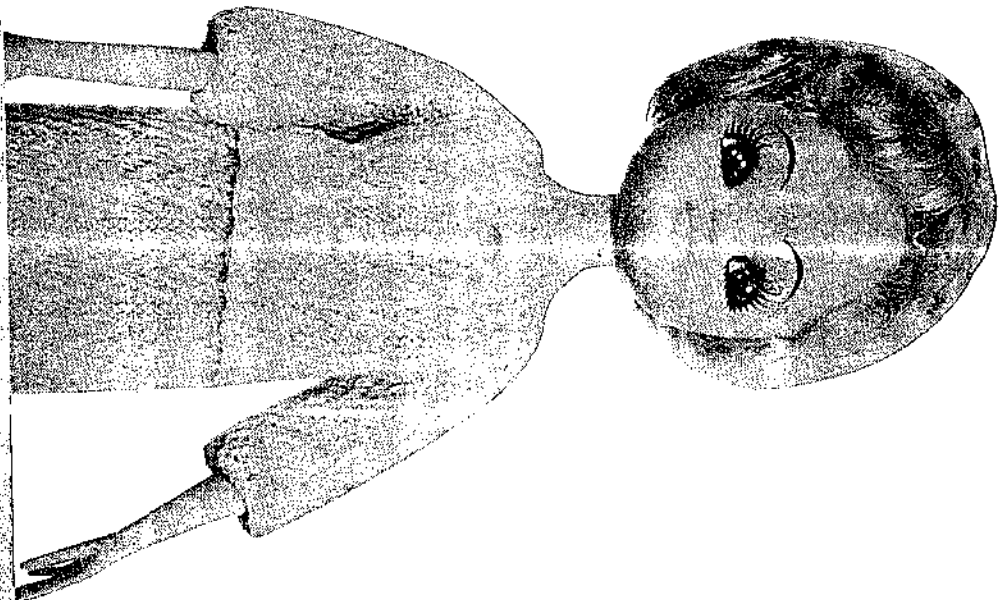

10. Colored zigzag pattern

Steps	24	23	22	21	20	19	18	17	16	15	14	13	12	11	10	9	8	7	6	5	4	3	2	1
Direction of Carriage Movement	→	←	→	←	→	←	→	←	→	←	→	←	→	←	→	←	→	←	→	←	→	←	→	
Color of Yarn	A	B	A	B	A	B	A	B	A	B	A	B	A	B	A	B	A	B	A	B	A	B	A	
Tension Dial	7	1	7	1	7	1	7	1	7	1	7	1	7	1	7	1	7	1	7	1	7	1	7	
Carriage																								
Laying-in Pattern Apparatus	1	2	3	4	5	6	7	8	9	10	11	12	13	14	15	16	17	18	19	20	21	22	23	24
Needle Selector	1	2	3	4	5	6	7	8	9	10	11	12	13	14	15	16	17	18	19	20	21	22	23	24
Buttons	1	2	3	4	5	6	7	8	9	10	11	12	13	14	15	16	17	18	19	20	21	22	23	24
Pattern Center	1	2	3	4	5	6	7	8	9	10	11	12	13	14	15	16	17	18	19	20	21	22	23	24
Reverse Knob	1	2	3	4	5	6	7	8	9	10	11	12	13	14	15	16	17	18	19	20	21	22	23	24
Slide Dial	1	2	3	4	5	6	7	8	9	10	11	12	13	14	15	16	17	18	19	20	21	22	23	24

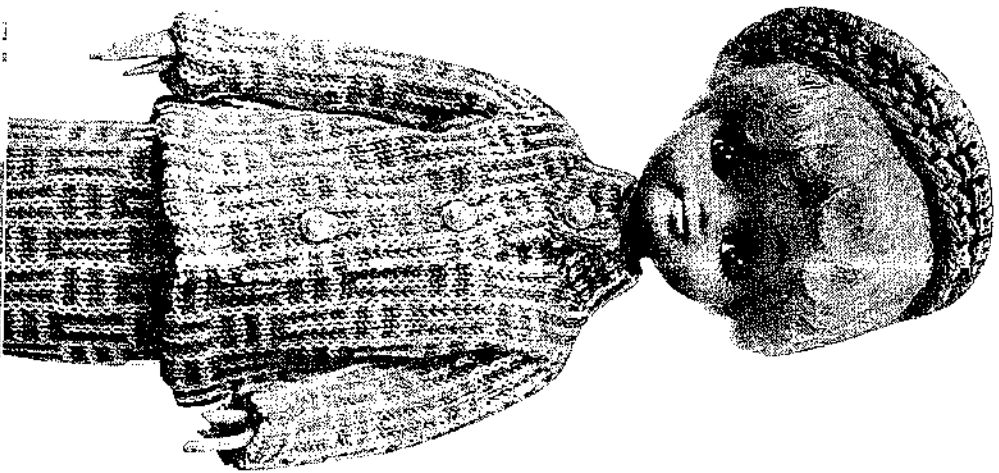

Laying-in patterns

Laying-in pattern apparatus is one of the wonderful features making the knitter a versatile instrument for various types of knit wear.

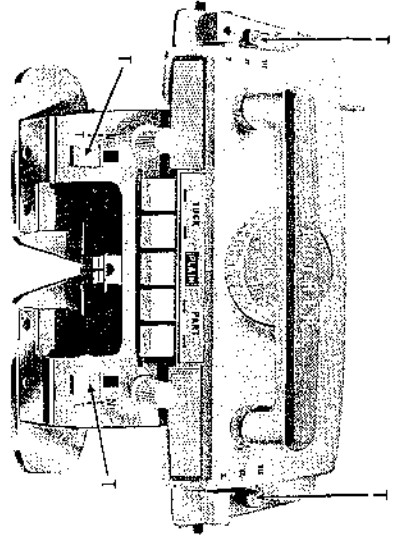

- Setting of carriage. I
- Holding cam levers I
- Pattern Selector button Plain
- Laying-in levers P
- Knobs for laying-in brushes T

11. Laying in pattern (1)

The following is the basic laying-in pattern.

Steps	1	2	3	4	5	6	7	8	9	10	11	12
Direction of Carriage Movement	←	→	←	→	←	→	←	→	←	→	←	→
Color of Yarn	A	B	A	B	A	B	A	B	A	B	A	B
Tension Dial	1	2	1	2	1	2	1	2	1	2	1	2
Carriage												
Needle Selection Buttons	1	2	3	4	5	6	7	8	9	10	11	12
Reverse Knob												
Slide Dial												
Laying-in Pattern Apparatus												
Laying-in Thread												

Main Yarn A 4 ply yarn
 Laying-in Yarn B 4 "

Step 1

- Main yarn A
 - Laying-in yarn B
 - Tension dial 6
 - Holding cam levers 1
 - Pattern Selector button Plain
 - Needle selector buttons 1, 3, 5, 7
 - Reverse knob A
 - Slide dial 1
- (a) After setting as above, swivel set lever.
(b) After every needle selection, lay across the yarn B with the end of yarn in the same side as the carriage.
(c) Move the carriage from right to left.

Step 2

- (a) Change the reverse knob from position "A" to "B".
- (b) Same as above (b)
- (c) Move the carriage from left to right.

Step 3

Repeat step (1) and (2).

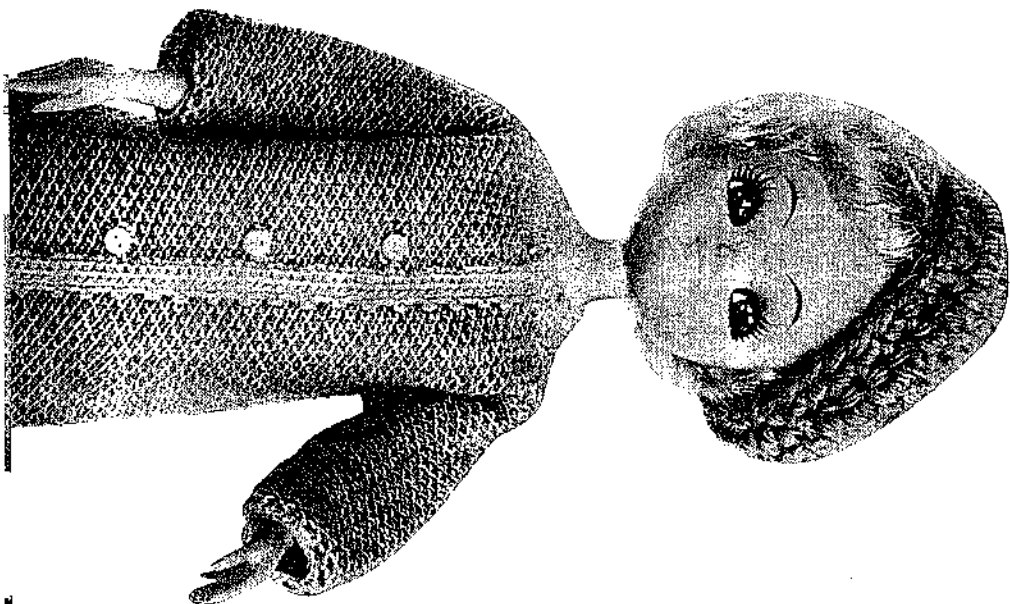
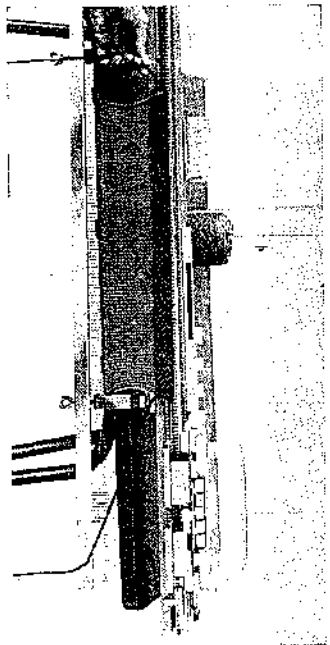

12. Laying-in pattern (2)

Stitch	1	2	3	4	5	6	7	8	9	10	11	12	13	14	15	16
Direction of Carriage Movement	→	→	→	→	→	→	→	→	→	→	→	→	→	→	→	→
Color of Yarn	A	A	A	A	A	A	A	A	A	A	A	A	A	A	A	A
Tension Dial	6	6	6	6	6	6	6	6	6	6	6	6	6	6	6	6
Carriage	1	1	1	1	1	1	1	1	1	1	1	1	1	1	1	1
Knit Selecter	1	2	3	4	5	6	7	8	9	10	11	12	13	14	15	16
Buttons																
Pattern Center																
Slide Dial																
Laying-in Pattern Apparatus																
Laying-in Thread																

Main Yarn A 4 ply yarn
 Laying-in Yarn B 4 "

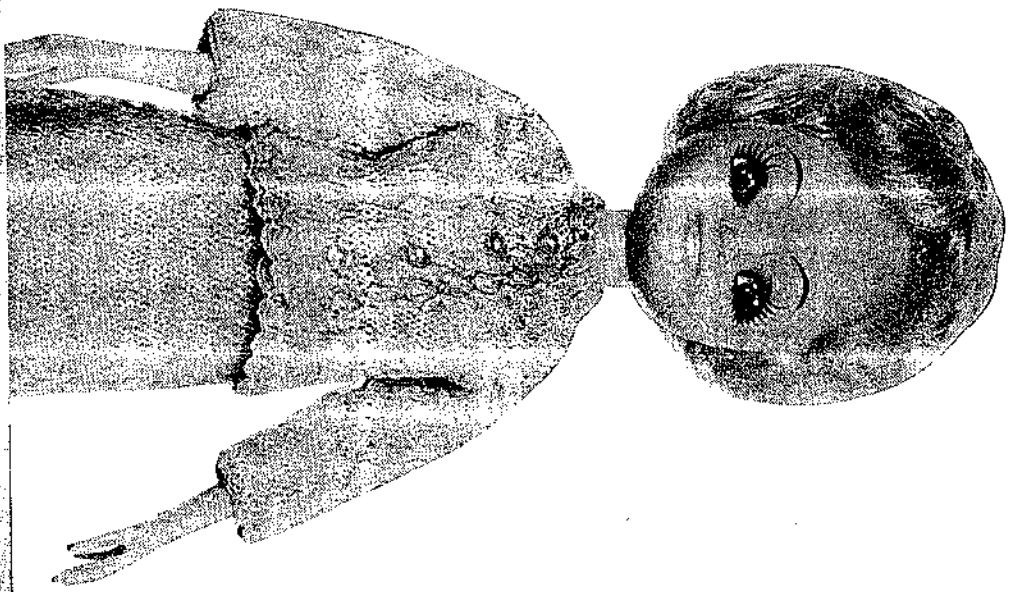

13. Laying in pattern (3)

For this pattern, thick wool is suitable as laying-in yarn.

Steps	1	2	3	4	5	6	7	8	9	10	11	12
Direction of Carriage Movement	→	→	→	→	→	→	→	→	→	→	→	→
Color of Yarn	A	B	A	B	A	B	A	B	A	B	A	B
Tension Dial	1	2	3	4	5	6	7	8	9	10	11	12
Carriage	1	2	3	4	5	6	7	8	9	10	11	12
Scale Selector	1	2	3	4	5	6	7	8	9	10	11	12
Inverse Knob	1	2	3	4	5	6	7	8	9	10	11	12
Buttons	1	2	3	4	5	6	7	8	9	10	11	12
Pattern Center	1	2	3	4	5	6	7	8	9	10	11	12
Slide Dial	1	2	3	4	5	6	7	8	9	10	11	12
Laying-in Thread	A	B	A	B	A	B	A	B	A	B	A	B

- Main Yarn A 4 ply yarn
- Laying-in Yarn B Bulky yarn
- Laying-in Yarn C Bulky yarn

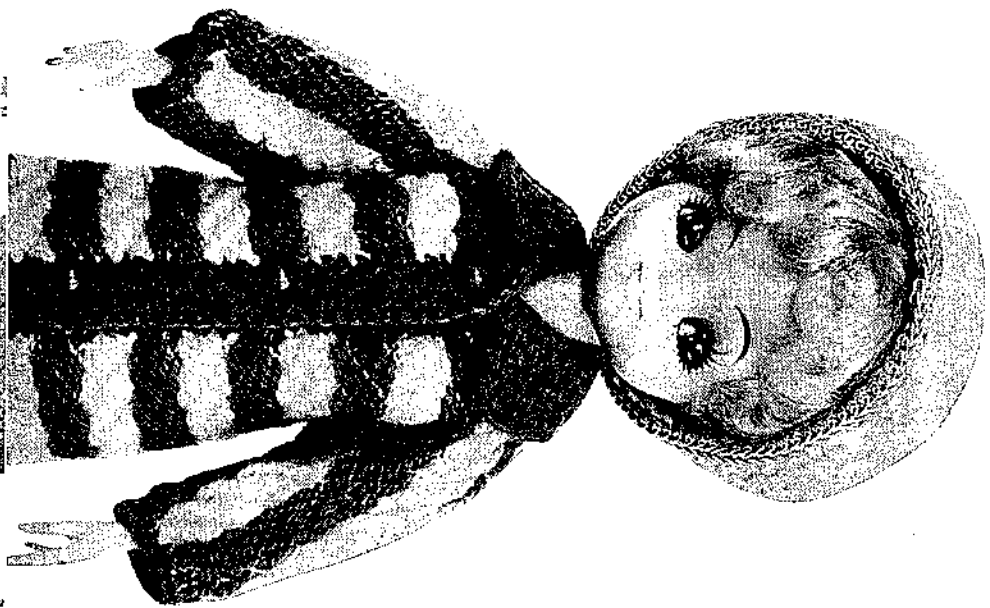

14. Laying-in pattern (4)

Steps	6	5	4	3	2	1	6	5	4	3	2	1	6	5	4	3	2	1
Direction of Carriage Movement	→	→	→	→	→	→	→	→	→	→	→	→	→	→	→	→	→	→
Color of Yarn	*	*	*	*	*	*	*	*	*	*	*	*	*	*	*	*	*	*
Tensinn Dial	6	5	4	3	2	1	6	5	4	3	2	1	6	5	4	3	2	1
Carriage																		
Knit Slider																		
Pattern Center																		
Slide 1/4"																		
Laying-in Pattern Apparatus																		
Laying-in Thread																		

{ Main Yarn A 4 ply yarn
 { Laying-in Yarn B 4 "

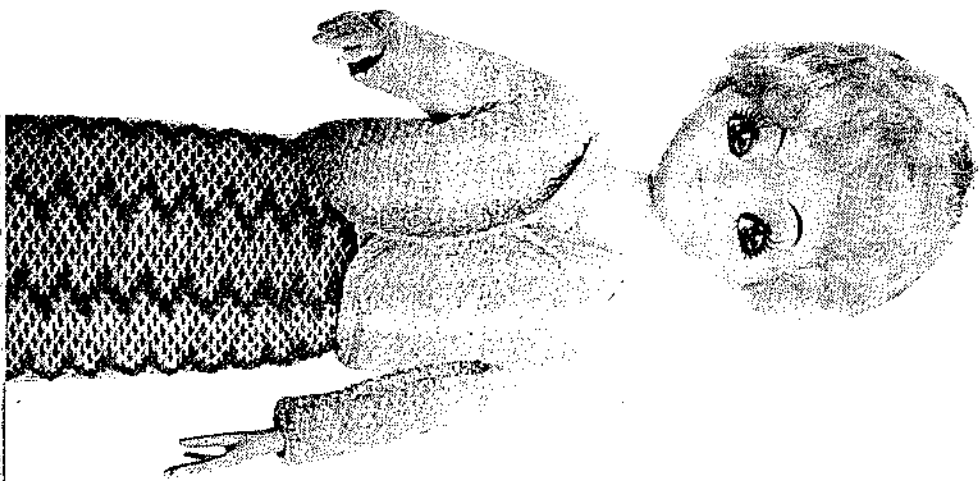

15. Tube knitting

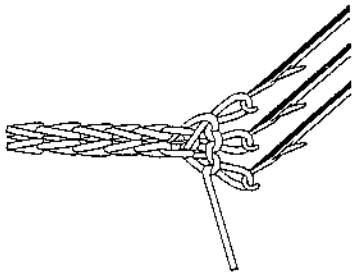

- ① Cast-on 3 or 4 needles.
- ② To get fine finish, use a slightly tight tension.
- ③ Depress right PART button.
- ④ Pull down the fabric by left hand, and move the carriage by right hand.

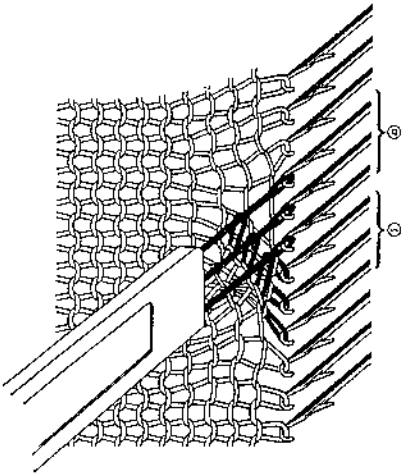

③ Place the three stitches on the other transfer tool in your right hand onto the hooks of the needles on the left.

Push the stitches behind the latches.

Raise those six needles to position "1/2"

Knit 10 rows.

Rib two or three stitches on both sides of the pattern starting at the beginning of the knitting.

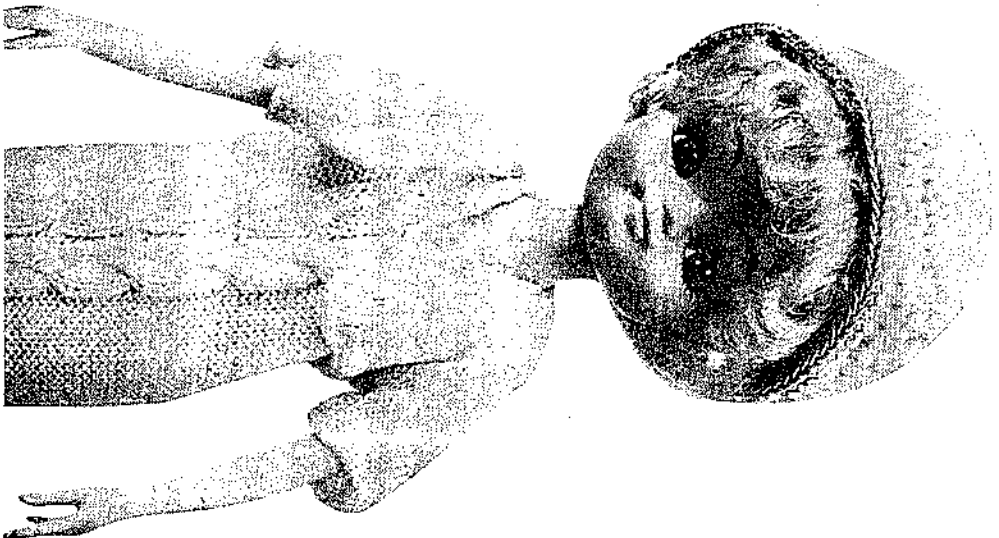

17. Ribbing stitch

The latch tool is used.

The ribbing is produced by having knit stitch over knit stitch and purl stitch over purl, in vertical lines. The ribbing narrows and lengthens the knitted fabric and increases its elasticity.

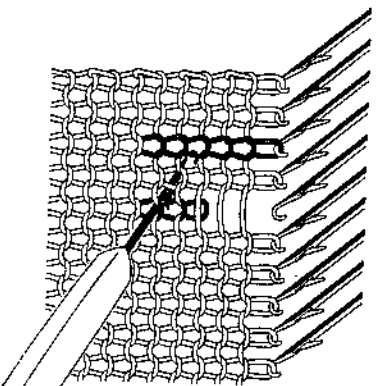
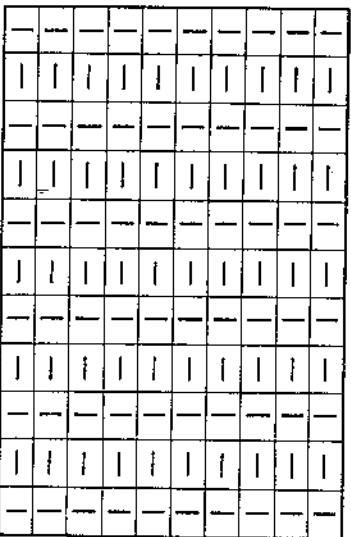

① Knit as many rows as required for the length of the ribbing on a slightly tighter tension.

Drop the third stitch from the end by pushing the needle forward then back until the stitch drops off the needle. Then, allow the stitch to drop as far down the fabric as you wish.

Insert the hook of the latch handle into the loop of the last dropped stitch from the front of the fabric.

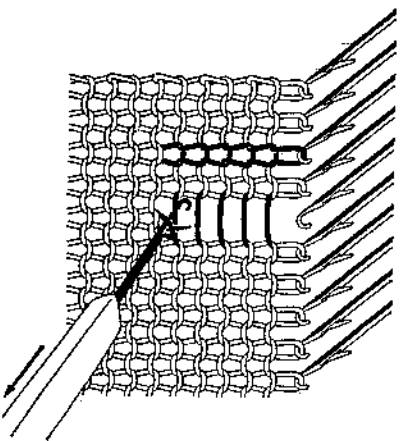

② Hold the tool parallel, and see that the stitch is behind the latch.

Catch the next parallel thread into the hook, and pull forward until new stitch is formed.

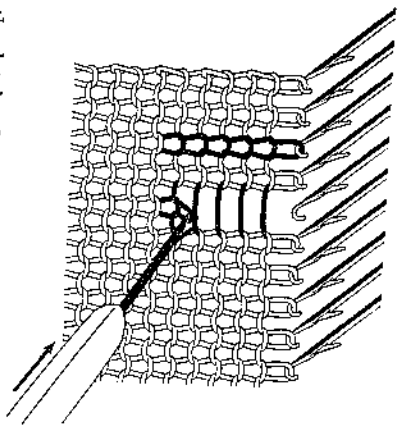

② Watch the latch of tool, always pick up parallel threads one by one.
 Note that the last stitch falls behind the latch so that the next parallel thread is in front of the latch.

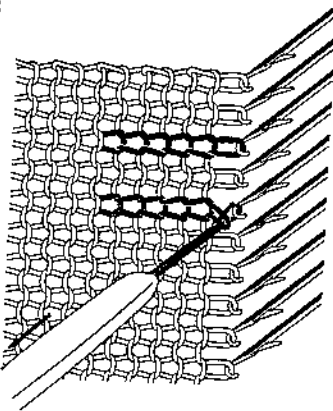

③ When all parallel threads are picked up, the last stitch is placed back onto the empty needle.
 Repeat steps ② and ③ for each row required to be "ribbed".

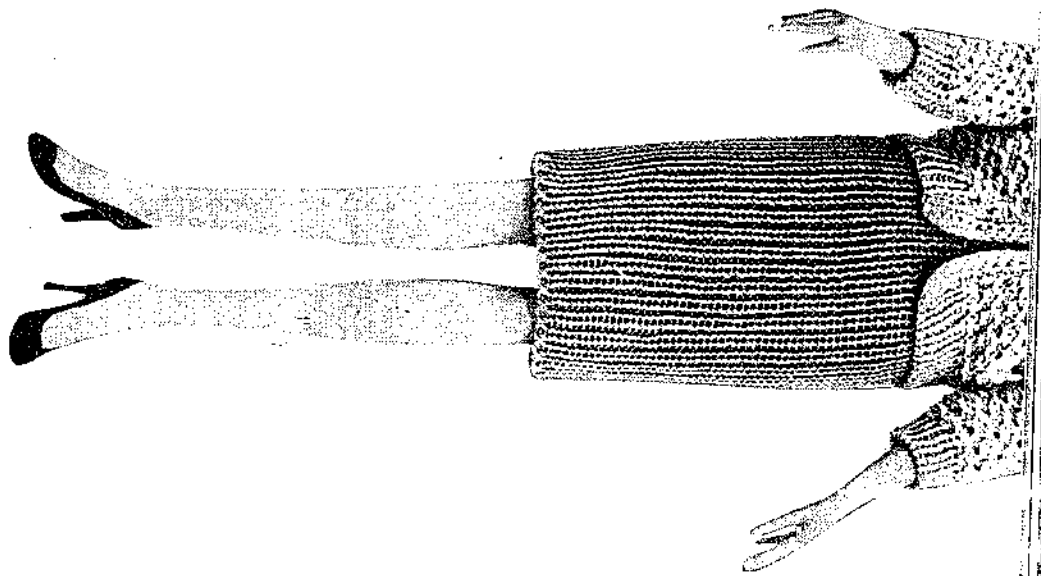

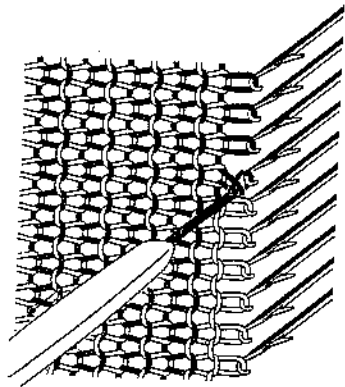

③ Repeat ① and ② operation about all stitches on one row.

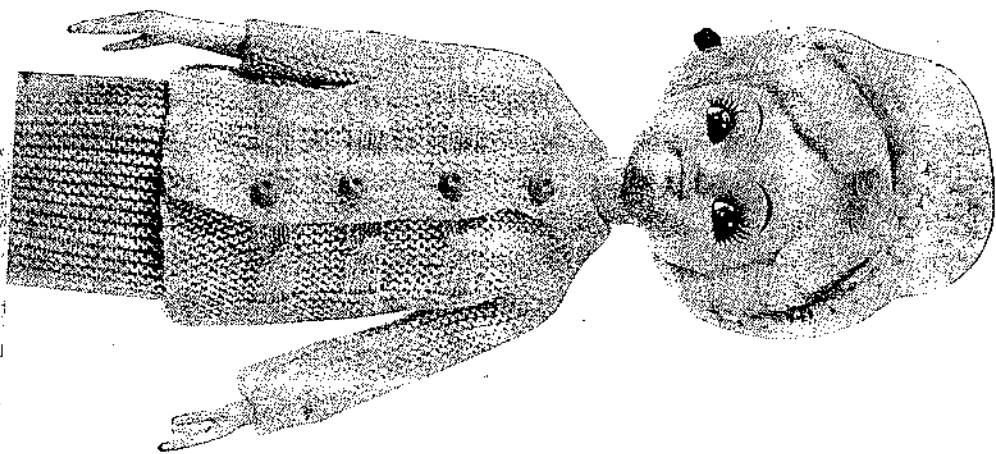

KNITTING LACE PATTERN USING L CARRIAGE

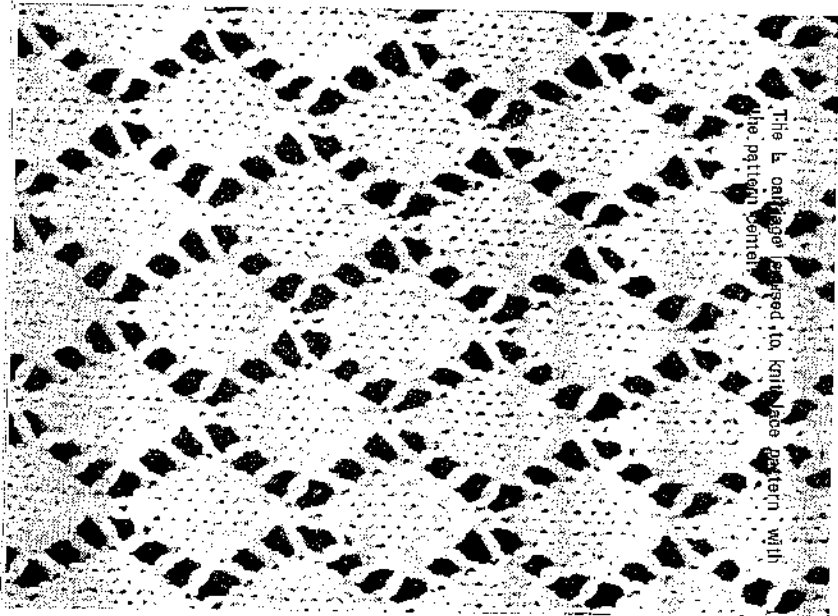

1. Preparing to knit

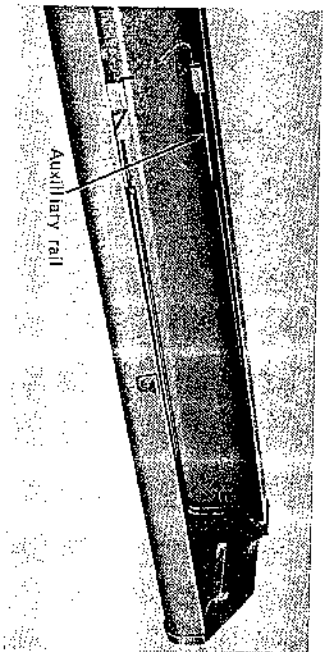

(1) Remove the auxiliary rails from the carriage case.

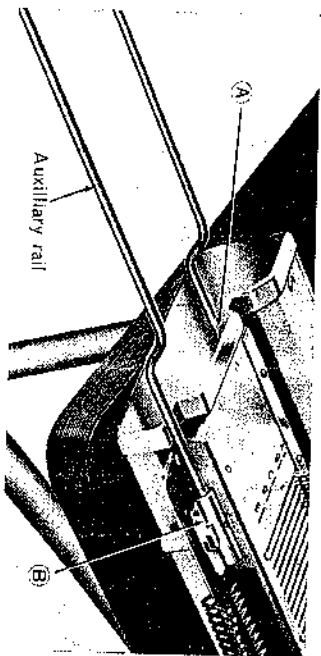

(2) Insert the auxiliary rail into the hole A and under the auxiliary rail fastener B on the end of knitting machine.

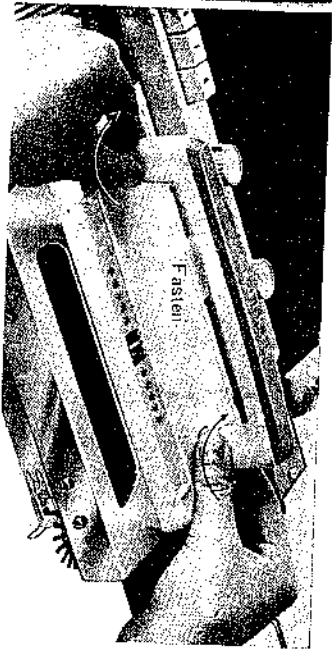

Fasten the handle on the L carriage.

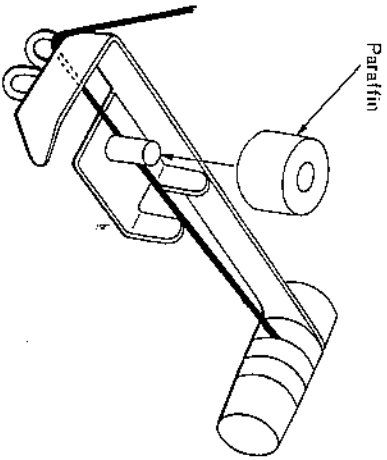

When you use 2-ply yarn or lace yarn fit paraffin to stud on front yarn guide.

2. How to use the L carriage

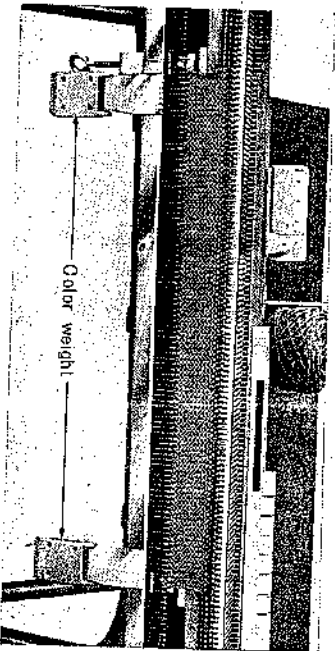

(1) Knit several rows in plain knitting, hang the color weight on the cast-on comb.

Yarn used	Tension Dial
2 ply	3
4 ply	5
lace yarn	4

(2) Set the tension dial as shown in the above table.

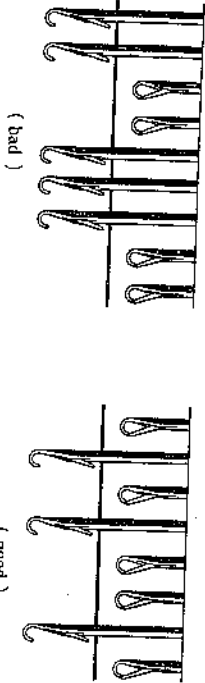

(3) Switch the set lever and select the needles.
When the needles are selected together with the adjacent needle, you can not knit. Therefore, make sure not to move the L carriage.

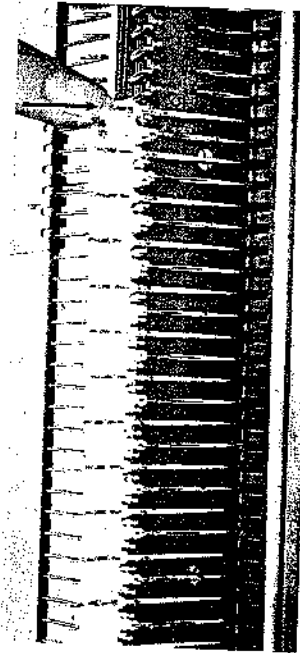

* In case of the endmost needle is selected, push it back with your finger.

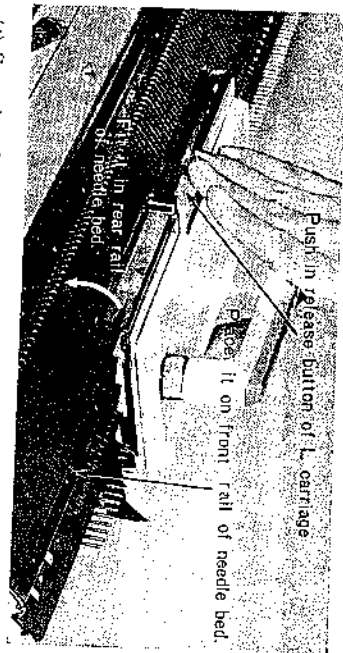

(4) Set the L carriage and make sure the rear side of L carriage fits in the back rail of needle bed.



(5) Move the L carriage slowly.

If the L carriage is jammed, see page 75.

(6) Knot with the carriage.

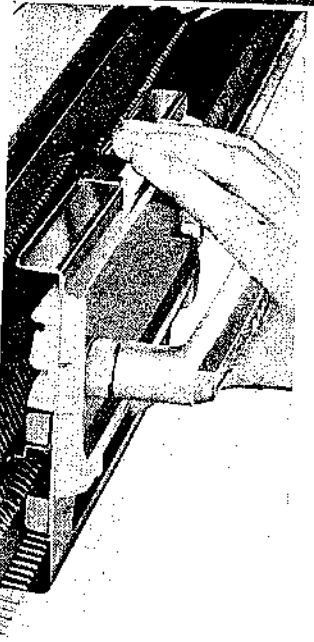

◀To unlock the L carriage▶

- ① Push in the release button of the L carriage
- ② Lift the rear of it and pull it toward you.

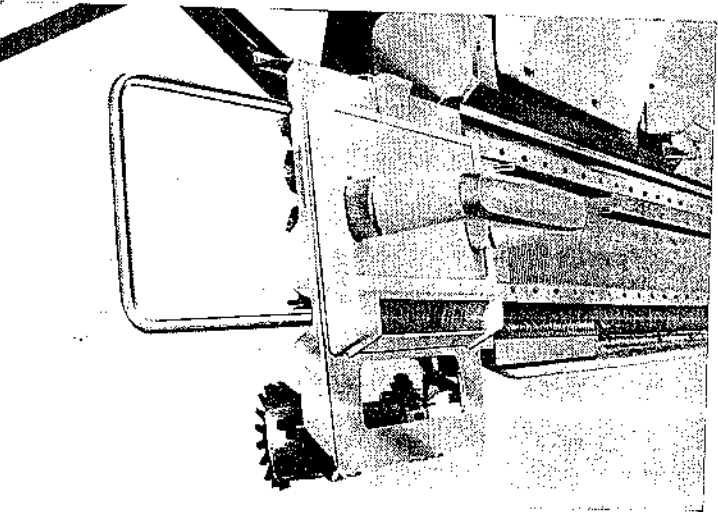

◀To reset the released L carriage on the auxiliary rail▶

When you reset the released L carriage on the auxiliary rail, place it right on the rail, as shown in figure.

3. How to knit Lace Pattern

How to read the pattern knitting table

◀Example▶

Steps	1	2	3	4	5	6	7	8	9	10	11	12	13	14	15	16	17	18	19	20				
Pattern Selector Buttons																								
Holding Cam Levers																								
Tension Dial																								
Reverse Knob																								
Slide Dial																								
Reverse Knob																								
Slide Dial																								
Direction of Lcarriage																								
Direction of Kcarriage																								

Steps:

Operate the knitter in numerical order.
The required operation is shown in the lateral row of each step.

Needle Selector Buttons:

a)  means pushing down button "1" and operation of the set lever.

b)  means operation of the set lever without pushing down button.

Slide dial:

Turn the slide dial before operating the set lever and set the slide indicator.

Direction of the L carriage:

Move the L carriage according to the direction of arrow.

Direction of the K carriage

Move the K carriage according to the direction of arrow.

→ one row
↺ two rows

* Always operate the L carriage before operating the K carriage.

* Place the K carriage at first on the right side of the needle bed.

* Set the reverse knob to position "A".

Lace pattern (1)

This is the most basic lace pattern.

Steps	1	2	3	4	5	6	7	8	9	10	11	12
Pattern Selector Buttons	1	2	3	4	5	6	7	8	9	10	11	12
Knitting Cam Levers	Both in	Both in	Both in	Both in	Both in	Both in	Both in	Both in	Both in	Both in	Both in	Both in
Tension Dial	Five	Five	Five	Five	Five	Five	Five	Five	Five	Five	Five	Five
Reverse Knob	○	○	○	○	○	○	○	○	○	○	○	○
Slide Dial	A	A	A	A	A	A	A	A	A	A	A	A
Direction of L carriage	↑	↑	↑	↑	↑	↑	↑	↑	↑	↑	↑	↑
Direction of K carriage	↪	↪	↪	↪	↪	↪	↪	↪	↪	↪	↪	↪

Step 1:

Push down needle selector buttons [1] and [3] and swivel set lever.

It is not necessary to reset the slide dial. (If the end needles are out to position "D", push them back with fingers.)

Move the L carriage slowly from right to left. (If the L carriage is jammed on the way, see page 75.)

Knit two rows by the K carriage.

Step 2:

Repeat step 1 from step 2 to step 6.

Step 7:

Swivel the set lever.

Move the L carriage from left to right.

Knit two rows by the K carriage.

Step 8:

Repeat step 7 in steps 8 through 12.

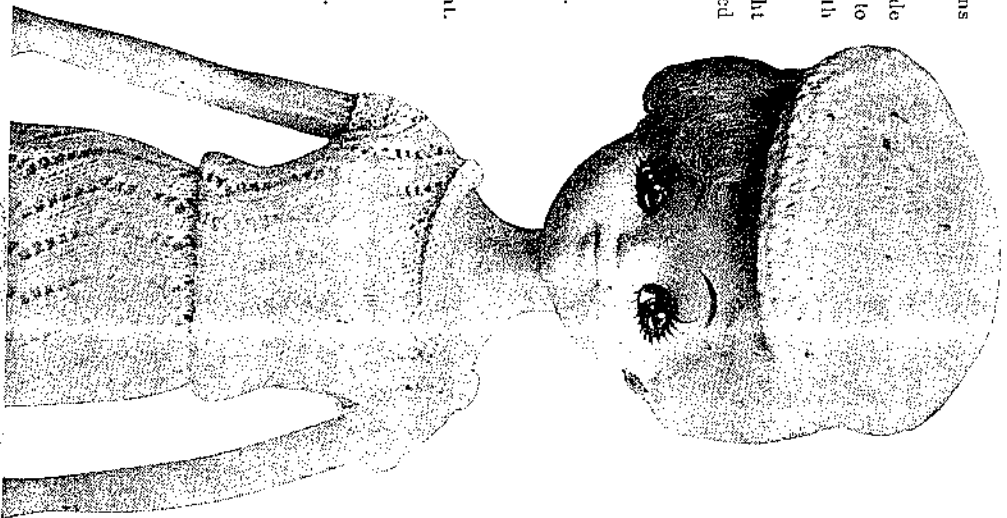

<<Lace pattern (2)>>

Steps	1	2	3	4	5	6	7	8	9	10	11	12		
Reverse Knob	○	○	○	○	○	○	○	○	○	○	○	○	"	"
Slide Dial	○	○	○	○	○	○	○	○	○	○	○	○	"	"
Pattern Selector Buttons													"	"
Holding Cam Levers													"	"
Tension Dial													"	"
Direction of Learriage	↓	↓	↓	↓	↓	↓	↓	↓	↓	↓	↓	↓	↑	↑
Direction of Kcarriage		↶	↷	↶	↷	↶	↷	↶	↷	↶	↷	↶	↷	↶

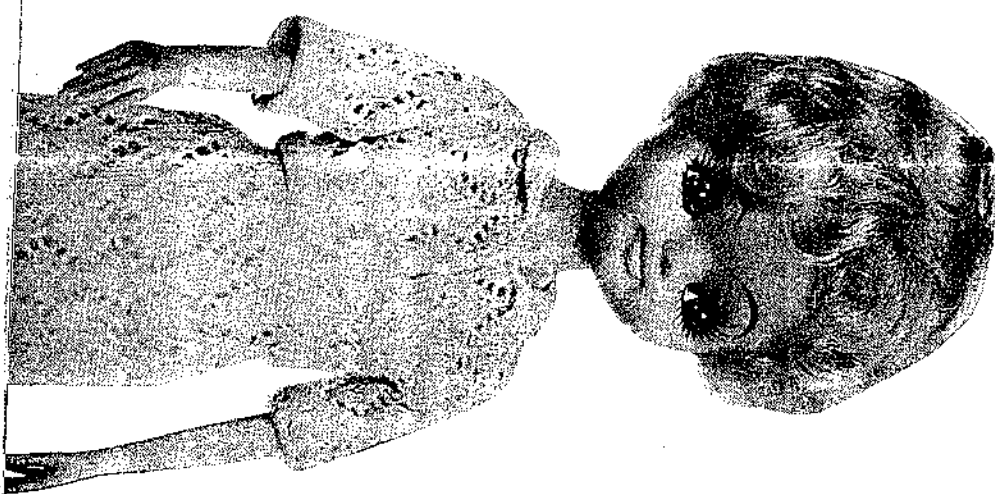

<>lace pattern (3)>>

12	1	2	3	4	5	6	7	8	9	10	11	12	"	"	"	"	"	"	↑	↺						
11	1	2	3	4	5	6	7	8	9	10	11	12	"	"	"	"	"	"	↓	↻						
10	1	2	3	4	5	6	7	8	9	10	11	12	"	"	"	"	"	"	↑	↺						
9	1	2	3	4	5	6	7	8	9	10	11	12	"	"	"	"	"	"	↓	↻						
8	1	2	3	4	5	6	7	8	9	10	11	12	"	"	"	"	"	"	↑	↺						
7	1	2	3	4	5	6	7	8	9	10	11	12	"	"	"	"	"	"	↓	↻						
6	1	2	3	4	5	6	7	8	9	10	11	12	"	"	"	"	"	"	↑	↺						
5	1	2	3	4	5	6	7	8	9	10	11	12	"	"	"	"	"	"	↓	↻						
4	1	2	3	4	5	6	7	8	9	10	11	12	"	"	"	"	"	"	↑	↺						
3	1	2	3	4	5	6	7	8	9	10	11	12	"	"	"	"	"	"	↓	↻						
2	1	2	3	4	5	6	7	8	9	10	11	12	"	"	"	"	"	"	↑	↺						
1	1	2	3	4	5	6	7	8	9	10	11	12	"	"	"	"	"	"	↓	↻						
													Reverse Knob	○	○	A	1									
													Slide Dial													
Pattern Selector Buttons	PLAIN																									
Holding Cam Levers	Both in I																									
Tension Dial	Five																									
Direction of Lcarriage													↓	↑	↓	↑	↓	↑	↓	↑	↓	↑	↓	↑	↓	↑
Direction of Kcarriage													↻	↻	↻	↻	↻	↻	↻	↻	↻	↻	↻	↻	↻	↻

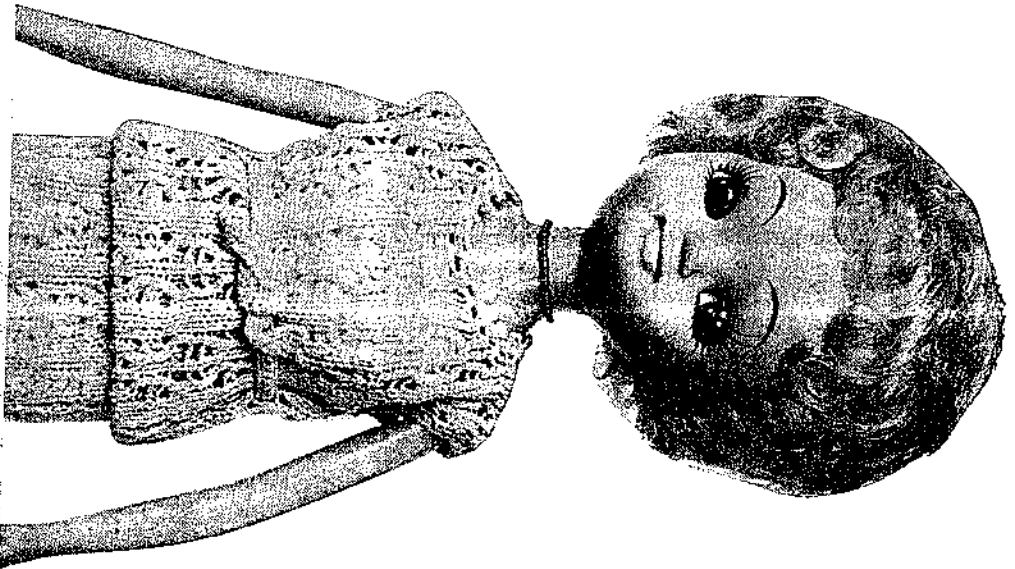

◀ Lace pattern (4) ▶

6												"	4	↘	↘
5												"	3	↘	↘
4												"	1	↘	↘
3												"	2	↘	↘
2												"	3	↘	↘
1												A	1	↘	↘
Steps	1	2	3	4	5	6	7	8							
Pattern Selector Buttons									Reverse Knob		Slide Dial				
Holding Cam Layers									PLAIN		Both in 1				
Tension Dial									Five						
Direction of Lcarriage														↘	↘
Direction of Kearriage														↘	↘

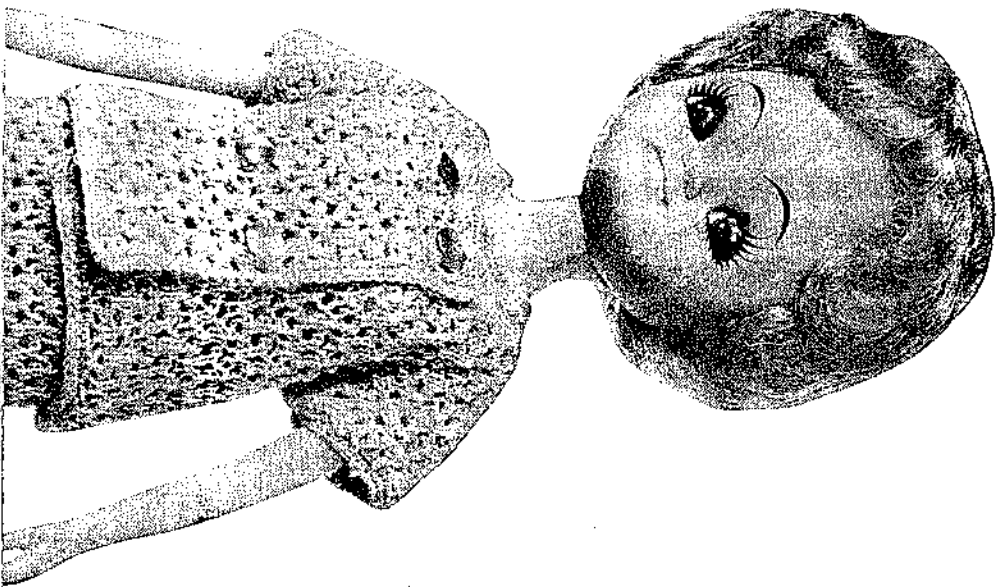

HOW TO KNIT GARMENTS

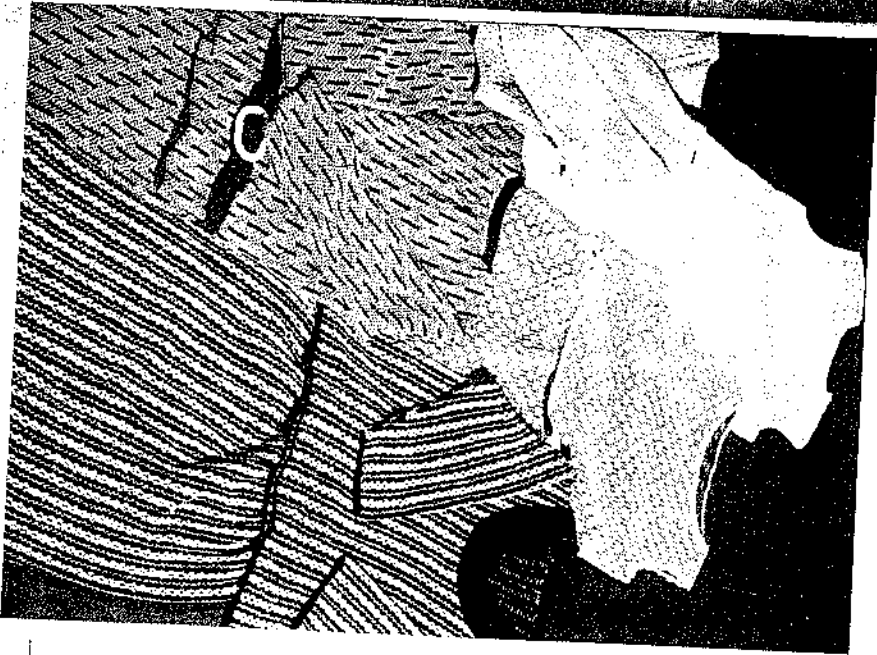

1. Partial knitting in Plain stitch Decreasing stitches

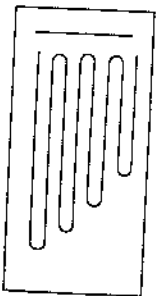

Set the holding cam levers in position "P".

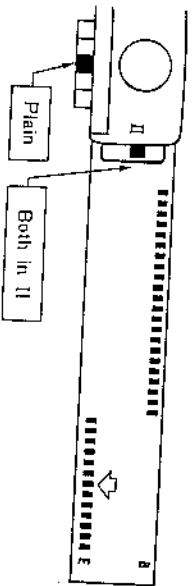

1) Bring up the needles in the opposite side of carriage, to position "P".
The number of needles to be raised to position "P", depends on the shape of the curve.

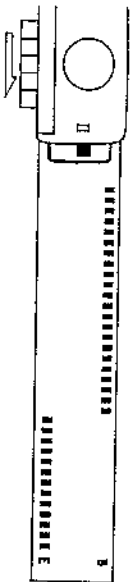

2) Knit one row.

When stitches are made with the needles in the position "B", the yarn lies across on the stems of the needles in position "E".

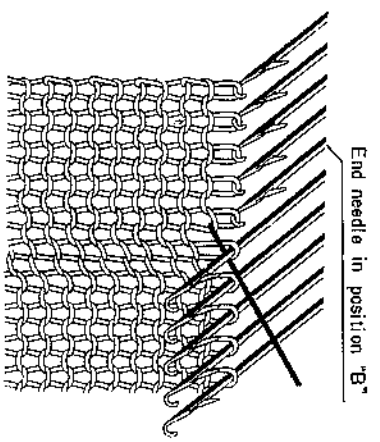

3) Pass the yarn under the stem of the first needle in position "E".

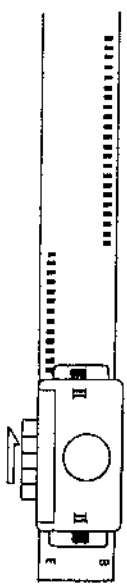

4) Knit one row.

Repeat steps (1), (2), (3) and (4).

• Increasing stitches

Set the holding cam levers in position I.

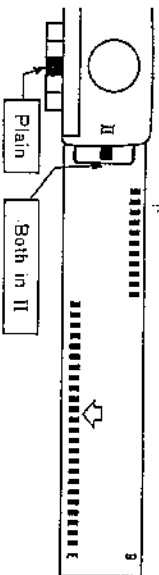
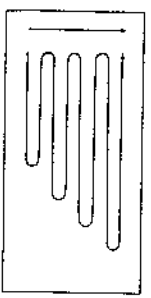

1) Bring up the needle in the opposite side of carriage, to position "E".
The number of needles to be raised to position "E" depends on the curve you want to get.

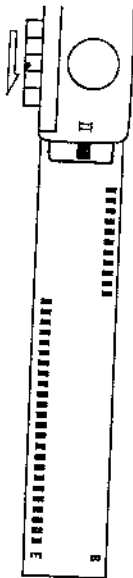

2) Knit one row.

When stitches are made with the needles in the position "D", the yarn lie across the stems of the needles in position "E".

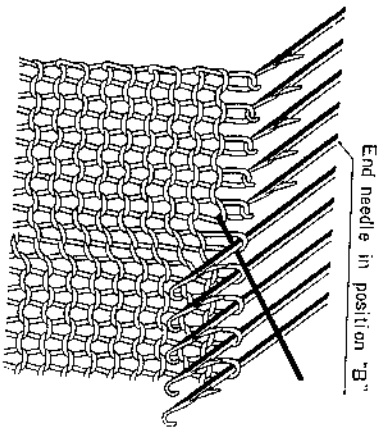

Pass the yarn under the stem of the first needle in position E.



4) Knit back one row.



5) Manually move back the needles from position "E" to "D" by the number of stitches you want to increase. Repeat steps (2), (3), (4) and (5).

2. Partial knitting of holding stitch pattern

Decreasing stitches

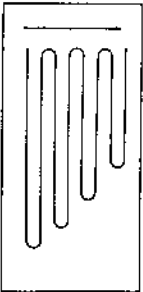

We take one holding pattern stitch for the purpose of explaining the above subject. Every fourth needle have 2 holding stitches and 2 plain stitches alternatively. Set the holding cam levers in position "II".

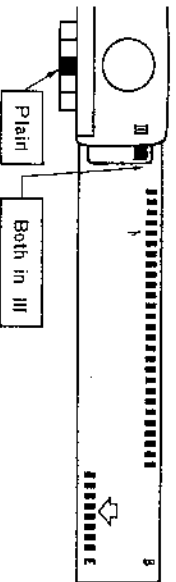

1) Raise the needles which you want to rest to position "E".

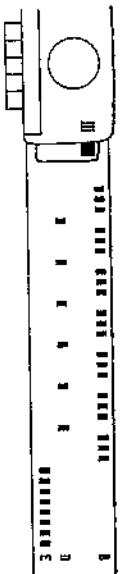

2) By using the needle selector buttons select the needles to hold up to position "I".

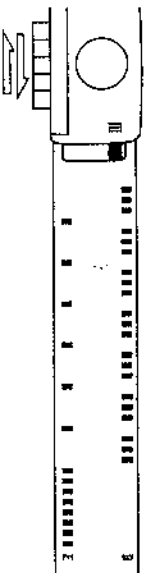

3) Knit 2 rows. But, at the end of the first row, pass the yarn under the stem of the first needle in position "E".

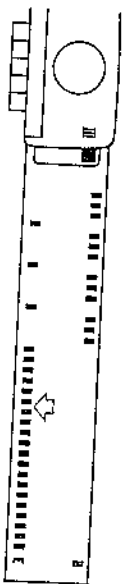

4) Raise several needles which you want to rest to position "E".

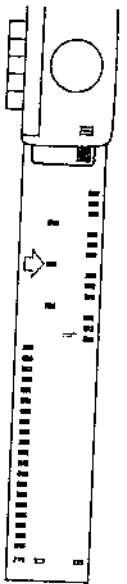

5) Move back the needles which have holding stitches from position "E" to "D".

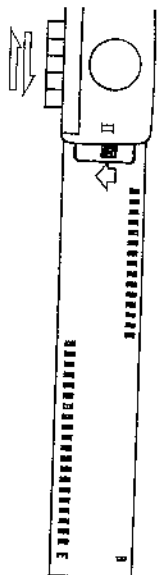

6) Shift the holding cam lever on knit side of the carriage from "II" to "I".
Knit two rows.

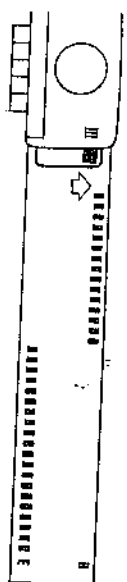

7) Shift the holding cam lever from "I" to "II". Repeat steps (1), (2), (3), (4), (5), (6) and (7).

• Increasing stitches

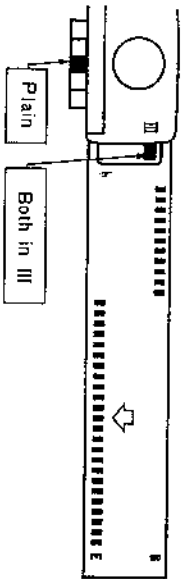
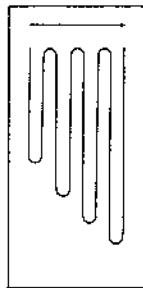

1) Raise the needles which you want to rest to position "E".

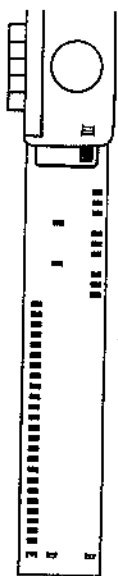

2) By using the needle selector buttons, select the needles to hold up to position "D".

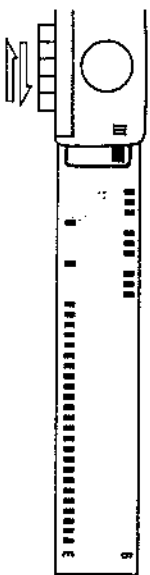

3) Knit 2 rows.

But at the end of the first row, pass the yarn under the stem of the first needle in position "E".

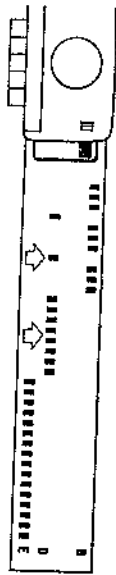

4) Move back the needles which have made holding stitches and those which you want to operate from "F" to "D".

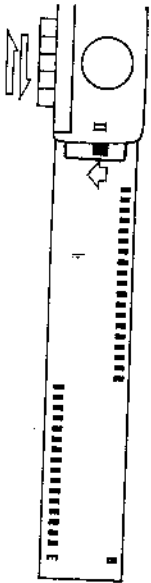

5) Shift the holding cam lever on knit side of the carriage from "II" to "I". Knit 2 rows.

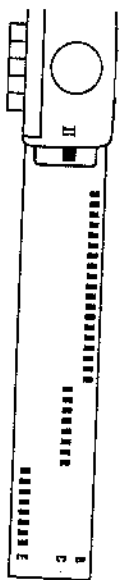

6) Move back the needles which you want to operate from "E" to "C".



7) Shift the holding cam lever from "I" to "III". Repeat steps (2), (3), (4), (5), (6) and (7).

3. Partial knitting of Tucking pattern

As one example, we select one tucking pattern. Every other needle has one tucking stitch and one plain stitch alternatively

Set the carriage.

When carriage is on the right-hand side of the knitting, push in left tuck button.

When carriage is on the left-hand side of the knitting, push in right tuck button.

Set both holding cam levers in position I.

• Decreasing stitches

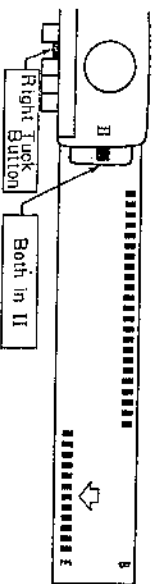
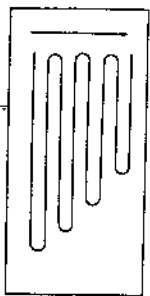

(1) Place the needles in position "B" and raise other needles to position "E".

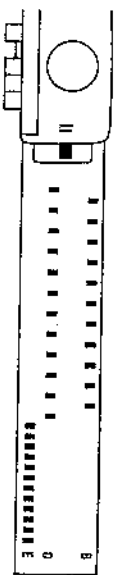

(2) Using the needle selector buttons select the needles to position "D".

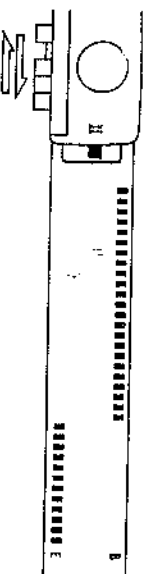

(3) Knit 2 rows.

But, at the end of the first row, pass the yarn under the stem of the first needle in position E.

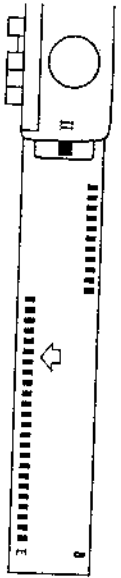

- (4) Raise the needles which you want to rest.
Using the needle selector buttons select the different needles from steps (2).
Knit 2 rows.
Repeat steps (1), (2), (3), (4), (5) and (6).

Increasing stitches

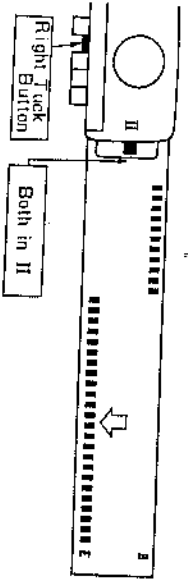
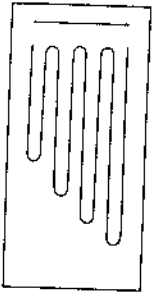

- (5) Place the needles to operate in position "T" and raise other needles to position "E".

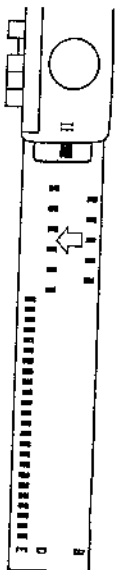

- (2) Using the needles selector buttons select the needles to position "P".

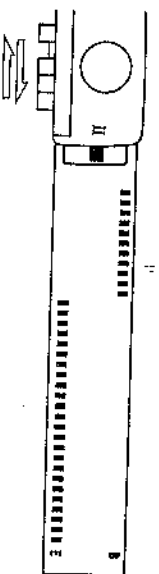

- (3) Knit 2 rows.
But, at the end of the first row, pass the yarn under the stem of the first needle in position "E".

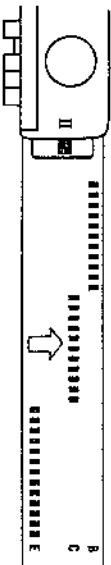

(4) Move back the needles which you want to operate to position C.

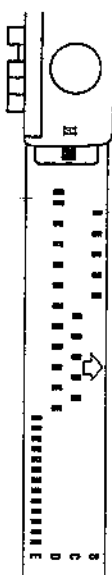

- (5) Using the needle selector buttons select the different needles from step (2).
- (6) Using the transfer tool, transfer the stitches on the back of the latches in position "C" onto the hooks of the needles and place these needles in position "F".
- (7) Repeat steps (2), (3), (4), (5) and (6).

<<How to transfer the stitch>>

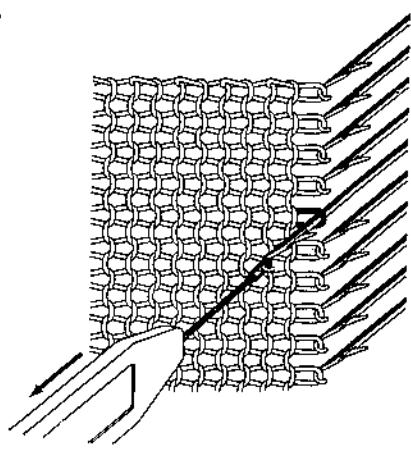

(1) Hold the transfer tool parallel with the needle and place the eye of the transfer tool into the hook of the needle. Bring the needle forward. The stitch in the hook of the needle will slide behind the latch and onto the needle.

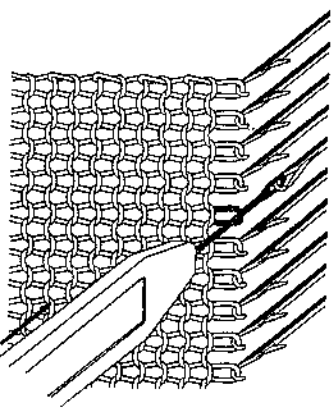

(2) Without releasing the transfer tool from the hook of the needle, push the needle all the way back until the stitch is transferred onto the transfer tool.

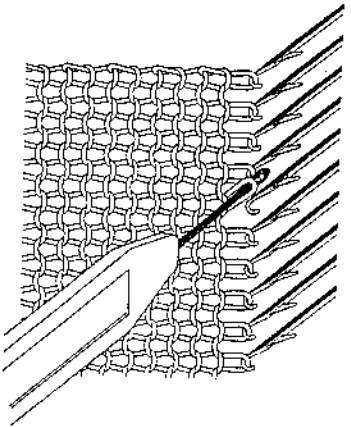

① Raise the transfer tool with the stitch on it and transfer it to the adjacent needle as shown by arrow.

Increasing stitch

Increasing one stitch at either edge

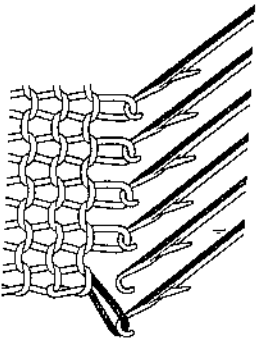

② Use the transfer tool, move the stitch out to the adjacent empty needle.

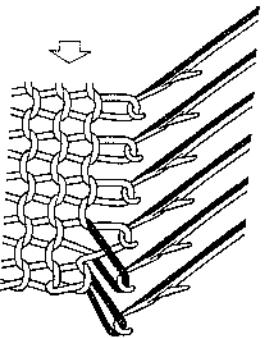

(2) To fill in empty needle pick up stitch from second needle in lower row.

Increasing several stitches at either edge.

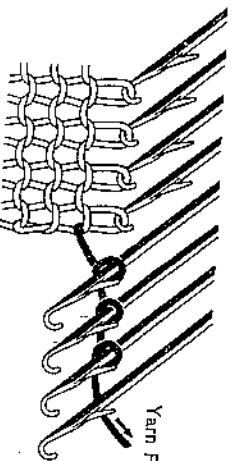

Yarn Feeder

Bring into action on the same side as the carriage. Raise the increasing needle to position "P". Wind yarn around stem of each needle. Raise the holding cam levers to position I. Knit across.

5. Decreasing stitch

• Decreasing one stitch at either edge

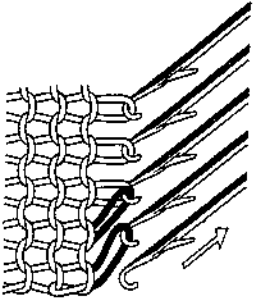

* Use the 2x1 transfer tool to transfer two stitches at the end to the inside needles, and place empty needle out of action to position "A".

Decreasing two stitches

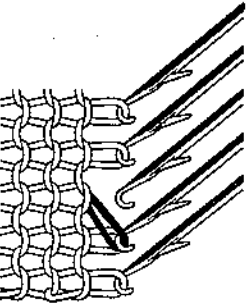

(1) Use the single transfer tool to transfer the 3rd stitch to the 2nd stitch.

(2) Transfer the 2nd stitch to the empty 3rd needle and the end stitch to the 2nd needle.
Place empty needle out of action.

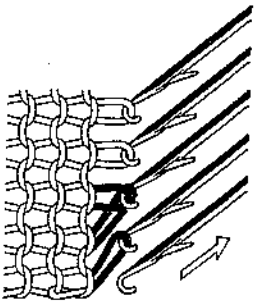

Decreasing several stitches

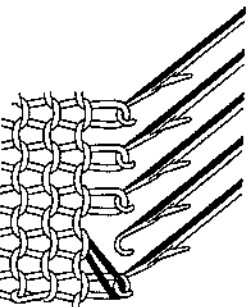

(1) Do it from the side where the carriage is placed.
Transfer the 2nd stitch to the end needle.

(2) Transfer the two stitches to the 2nd needle. Place empty needle out of action

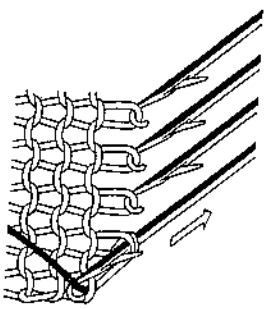
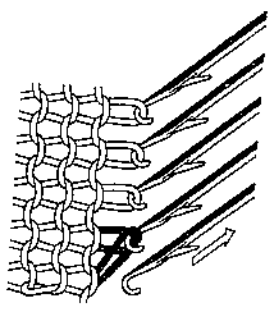

(3) Raise the needle with the two stitches so that the stitches fall behind the latch of the needle. Pla yarn in front of latch and manually pull needle bac to form a single stitch.

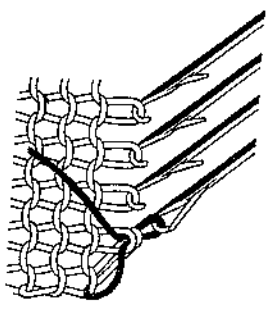

(4) Repeat this process. Transfer the last stitch to adjacent needle.

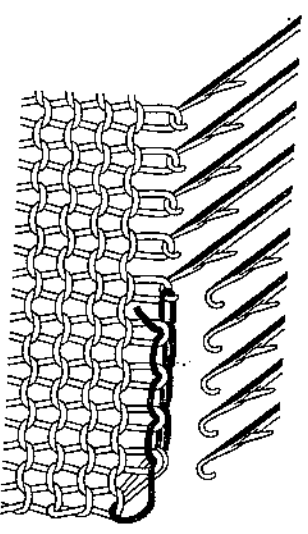

6. How to bind off

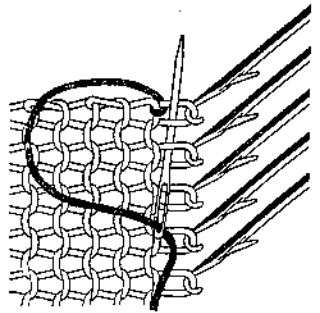
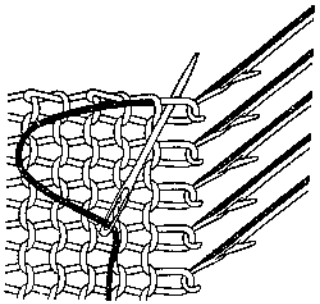

7. How to cast off

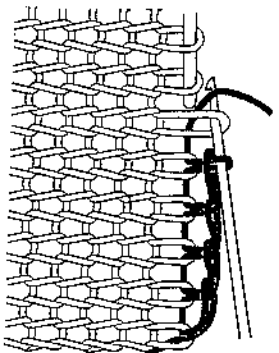

8. How to bind off one knit one purl

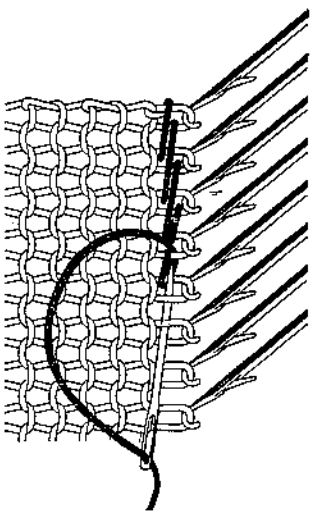
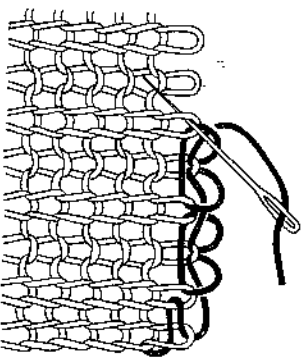

9. Waste knitting or loose course knitting.

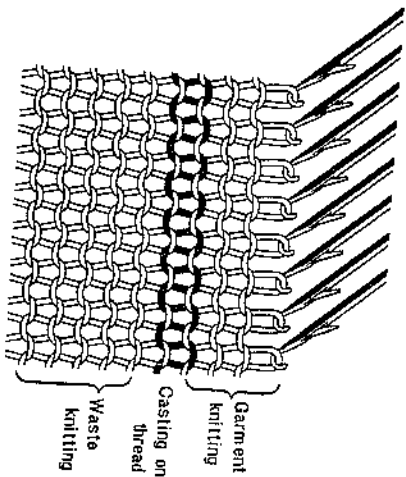

* To obtain a garment with a beautiful edge, waste knitting is used.

After waste knitting with waste yarn is finished, knit one row with the carriage with cast-on thread.

Then proceed to garment knitting.

After finishing the garment knitting, the garment and the waste knitting can be separated by pulling out the cast-on thread.

10. How to determine the gauge

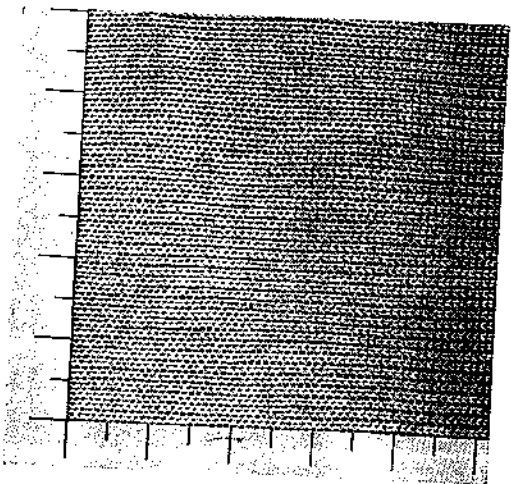

* The gauge or tension determines the tightness or looseness of the stitches.

Determine the proper gauge by making a swatch.

Knit a small test piece on about 30 needles, working sets of 30 rows, each set in a different tension.

Put the swatch on a plane.

Count the number of stitches per inch across, and the number of rows down per inch.

Based on this mathematical approach, it soon becomes a simple matter to create your own garments or your knitter with the assurance that the size will be correct.

It is recommended that a small test swatch be made before starting each garment to prove correctness of gauge.

II. Partial knitting with the L carriage

* Set the holding cam levers in position "1".

* Push down both PART buttons.

* Set the tension dial as shown in next table.

Numbers before setting	Setting Numbers
4	5
5	6
6	7

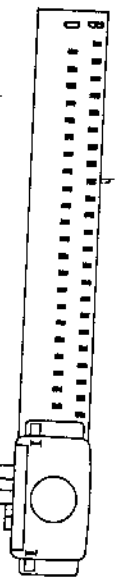

(1) As shown in the pattern knitting table, push down needle selector buttons and swivel set lever.

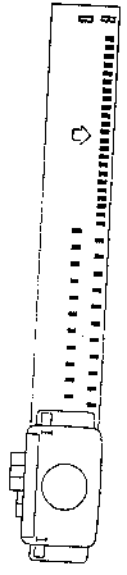

(2) Of the selected needles, those which are not used must be pushed back to position "P".

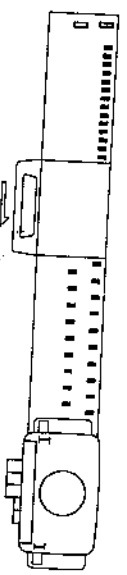

(3) Move the L carriage in the direction shown in pattern knitting table.

* If operation of the L carriage required more than once in the pattern knitting table, repeat steps (1), (2) and (3).

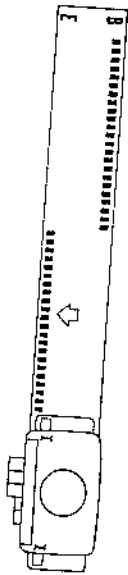

(4) Raise the knitted needle to position "E".

(5) Move the L carriage in the direction shown in pattern knitting table.

* Hang the yarn in the hook of the first needle in position "B".

TROUBLES AND REMEDIES

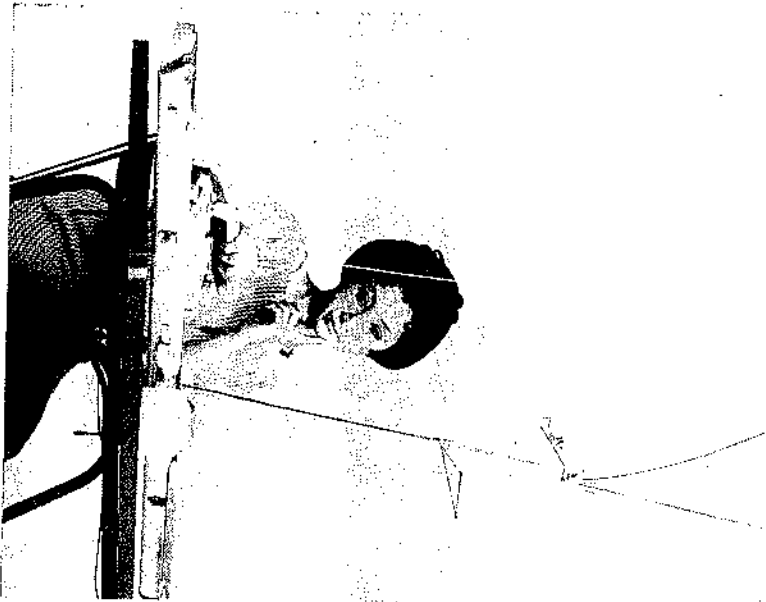

When the needle is bent

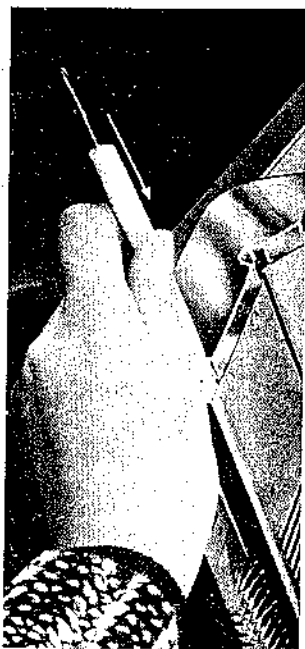

(1) Push either side of the felt bar and pierce with the end of latch tool until it comes out.

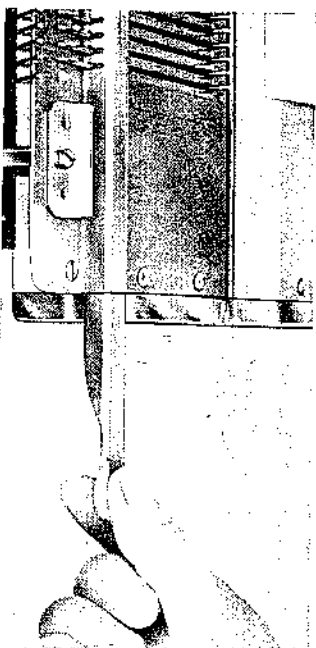

(2) Withdraw it by hand from the knife until the needle you wish to change is free.



(4) Pull the needle forward as far as it will go. Push down the hook of the needle until shank end of the needle rises clear of the needle bed.



(4) Grasp the shank end and draw it out backwards.

(5) Replace it with a new needle by holding it with latch opened. Push the felt bar back into place.

When the carriage is jammed

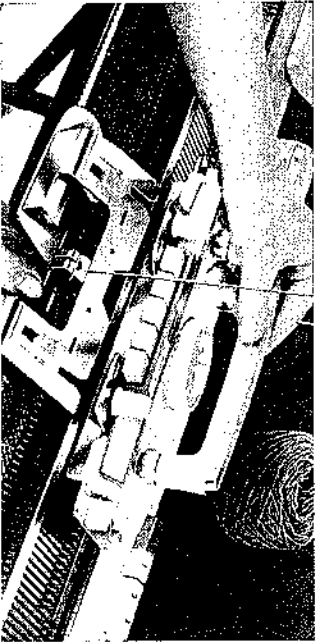

- (1) Loosen the thumb screws of the sinker plate, remove the sinker plate from the carriage.
- (2) Grip the handle of the carriage and lift the front of the carriage.
Slide the carriage to the side where the row commenced and when clear of needles lower the front onto the needle bed.
- (3) Attach the sinker plate to the carriage and fasten the thumb screws of the sinker plate securely.
- (4) Unravel last row of knitting and if necessary rethread carriage feeder.

<Undoing rows (unravelling)>

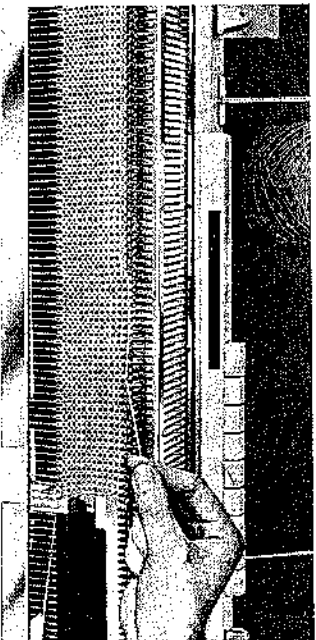

- (1) Pull the yarn slightly out of stitches.
The stitches of the previous row will slip into the hooks of needles automatically as the yarn is raised towards the needle bed.
- (2) Move the carriage in either direction without knitting.
- (3) Pull the ripped yarn down through the back of the rear yarn guide until the yarn take up spring is brought back into operation.
- (4) Adjust the numbers on the row counter.

◀ Carriage movement without knitting ▶

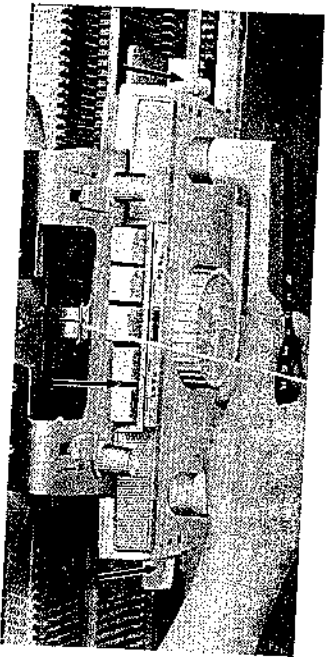

- * It is necessary to move the carriage without knitting over the needles which are in operation from one side of knitting to the other side.
- * Push down both PART buttons and set the holding cam levers to position "II".
- * If the needles are selected, put back the selected needles to position "B".

◀ How to remove the laying-in pattern brushes ▶

- * Set the laying-in pattern knobs to position "N" and remove the laying-in pattern brushes from the sinker plate assembly.

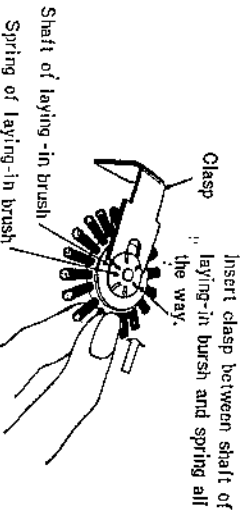
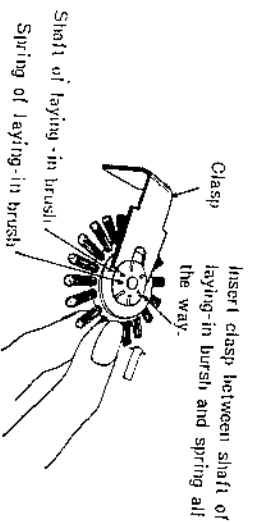

When the L carriage is jammed

- * Remove the L carriage from its jammed position.
- * If the L carriage is caught with needles, take sufficient care in removing it.
- * After removing the T carriage, you can knit according to following steps.

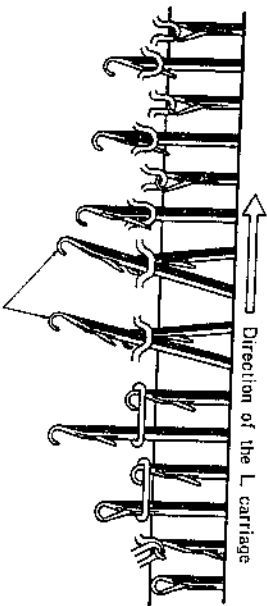

① If you see needles caught with each other, separate them by lifting their tips.

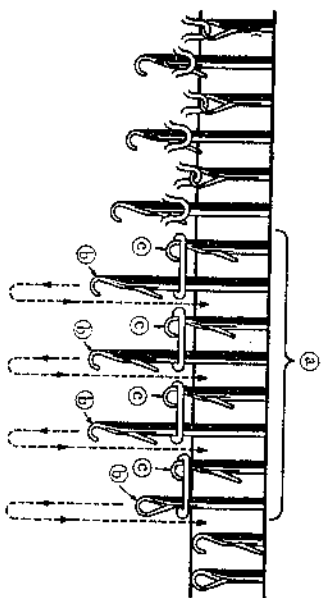

② If stitches are caught on two needles as shown by ② in above figure, pull selected needles ④ toward you and push them back together with needles ③ to position "1" in order to transfer the stitches.

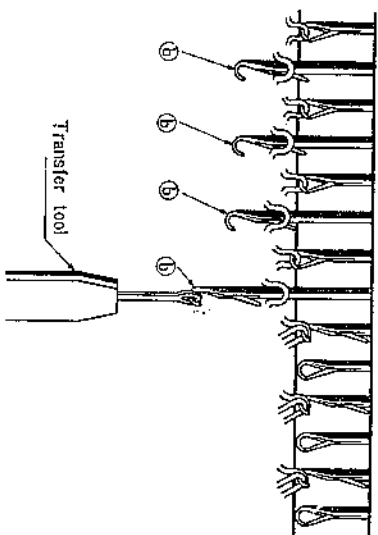

③ For other part, transfer the stitch of selected needles ④ with transfer tool to adjacent needle.
(For use of the transfer tool, see page 63)

CARE OF YOUR KNITTING MACHINE

For best results your knitter
visible working parts regularly oiled

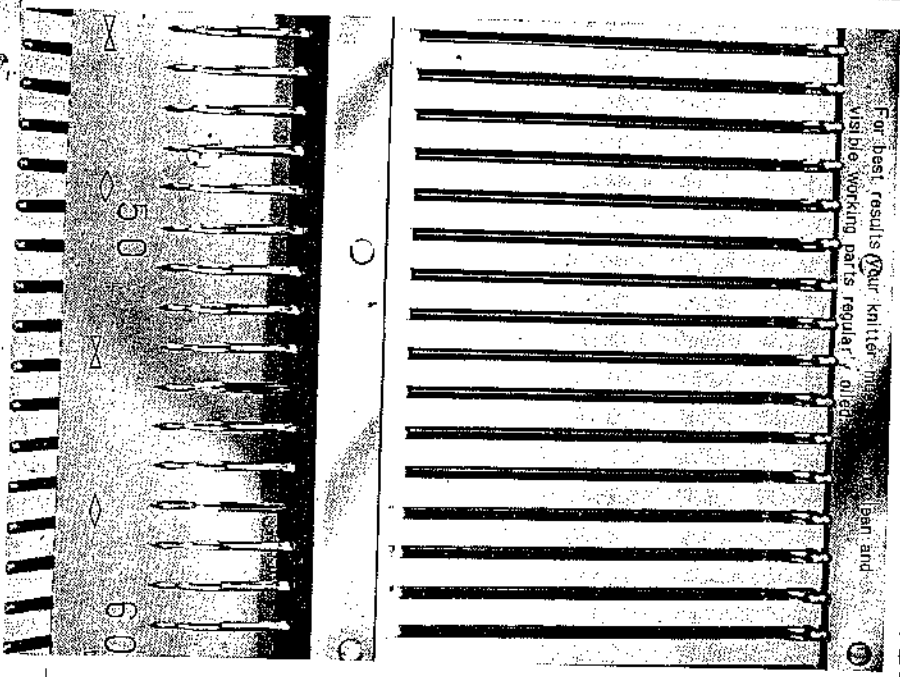

Oiling and cleaning

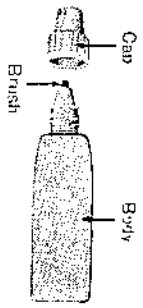

* Remove the cap and oil
your machine before and
after use.

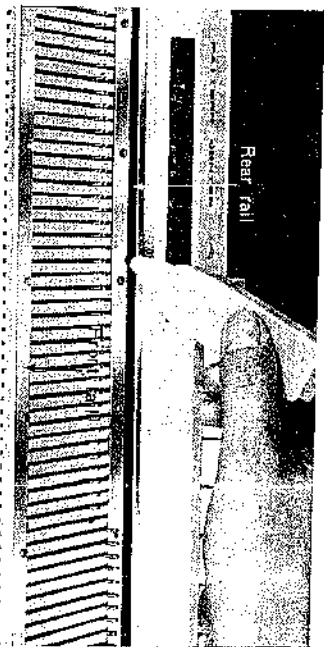

(1) The needle bed
Clean the needle bed and the carriage slide rails with
clean cloth.
Oil the needle bed and the carriage slide rails using oiler.

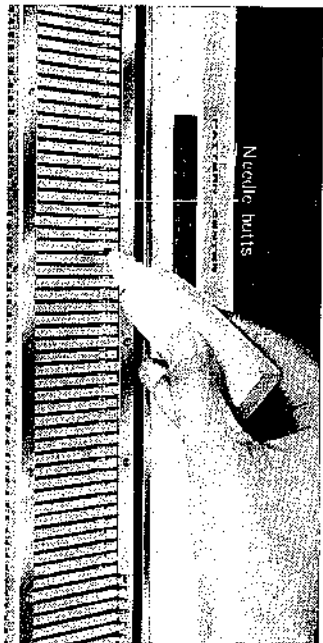

(2) The needle butts
Oil the needle butts with oil.

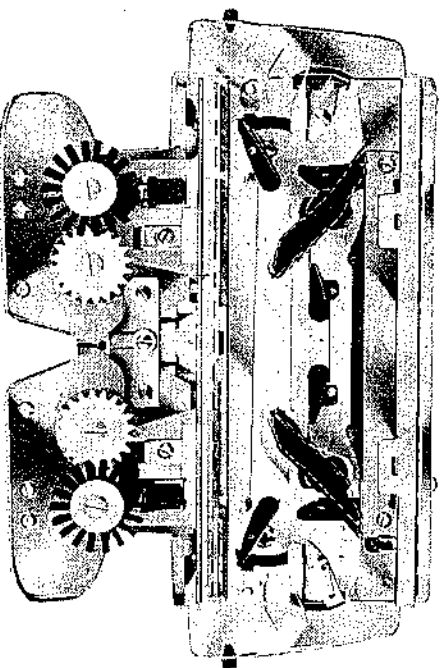

(3) The carriage
With clean cloth, wipe away all fluff.
Oil all moving parts of the carriage with oil.

• Note

Clean and oil your knitter each time you have finished knitting and clean off all excess oil before use, especially from parts which will come into contact with the knitting. Always leave a light film of oil on all parts between the rails under the carriage.

FOLDING UP THE KNITTER

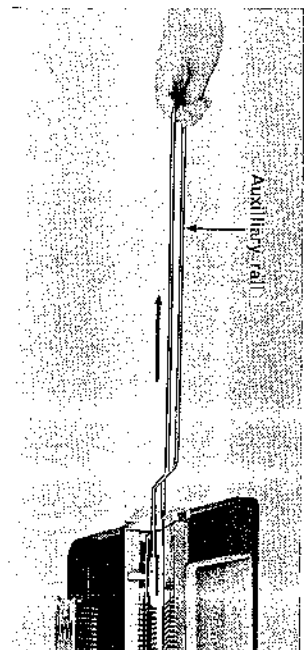
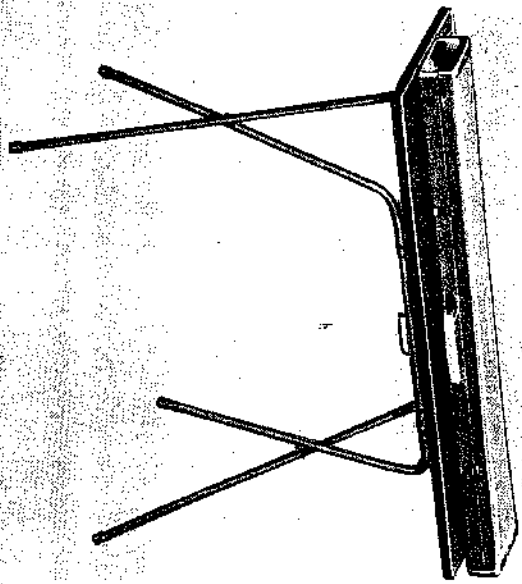

(1) Remove the auxiliary rail (lift up and pull it.)

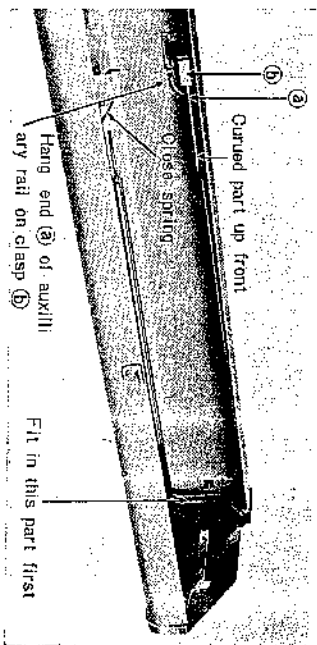

(2) Replace the auxiliary rails in the upper case as shown in figure.

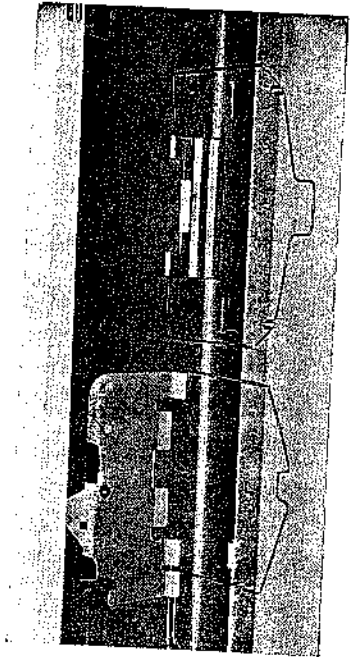

(3) Open the springs in the case.

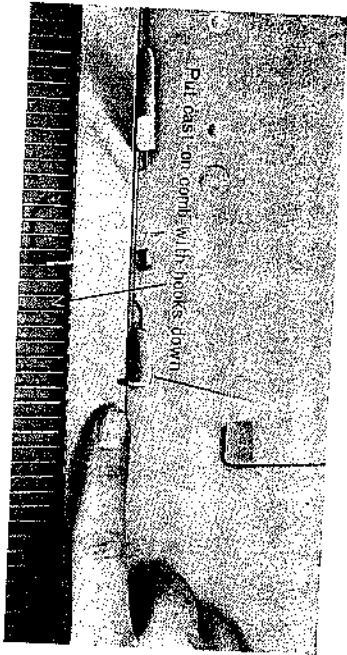

(4) Replace the cast-on comb in the case.

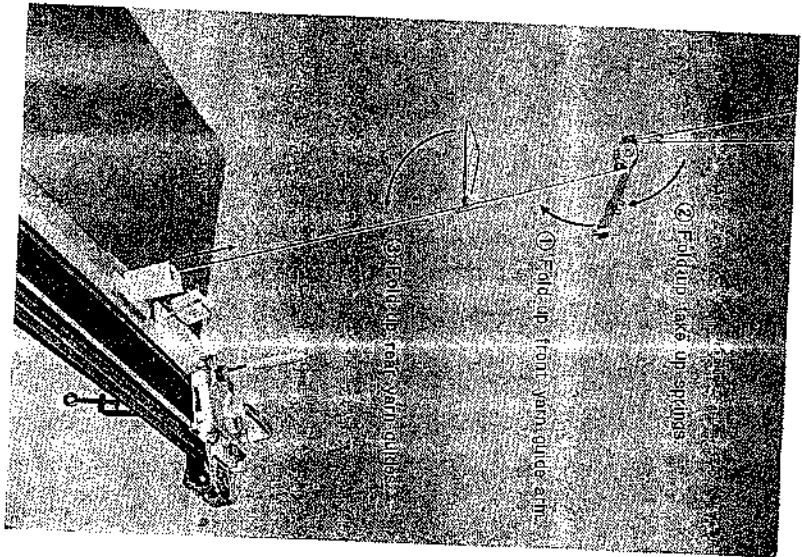

(5) Fold up the automatic yarn tension unit.
Remove the automatic yarn tension unit.

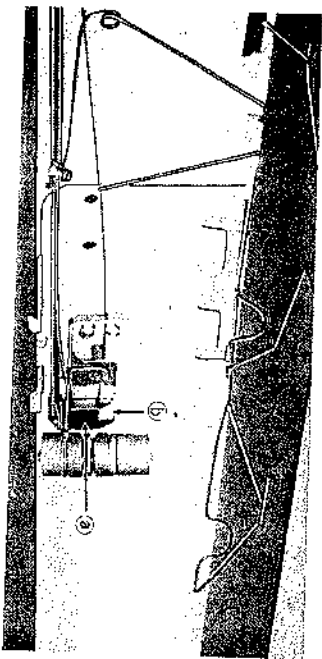

(6) Replace the automatic yarn tension unit as shown in figure. (Fit the head **D** of automatic yarn tension unit under the clasp **D** of the case.)

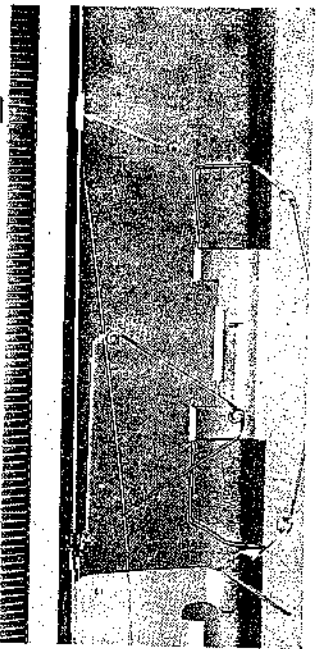

(7) Place the yarn tension rod and the take-up spring beside comb and put them inside of hook **C**.

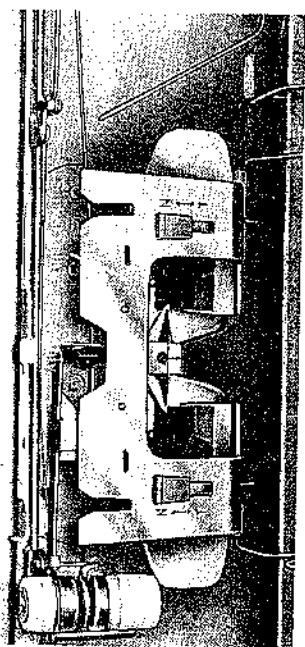

(8) Remove the sinker plate and replace it as shown in figure.

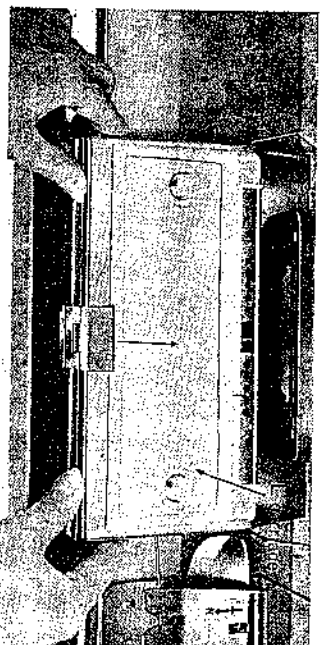

(9) Remove handle from the I. carriage and replace the I. carriage as shown in figure.

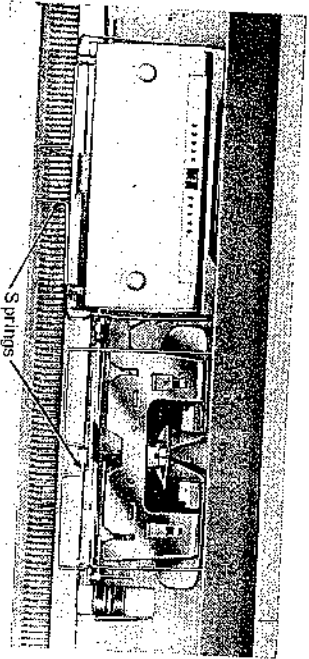

(10) Close the springs.

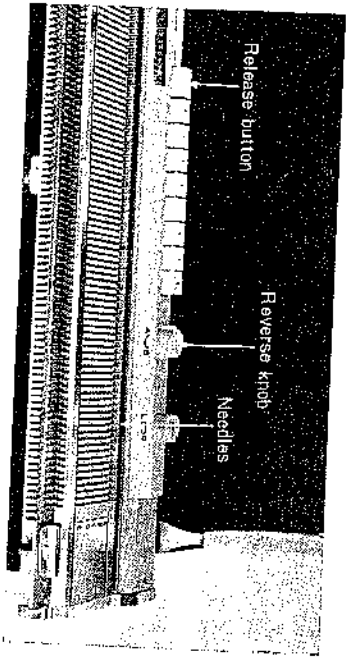

(11) Remove the set lever, push down the release button, set the reverse knob to "A" and push back all needles to position "A".

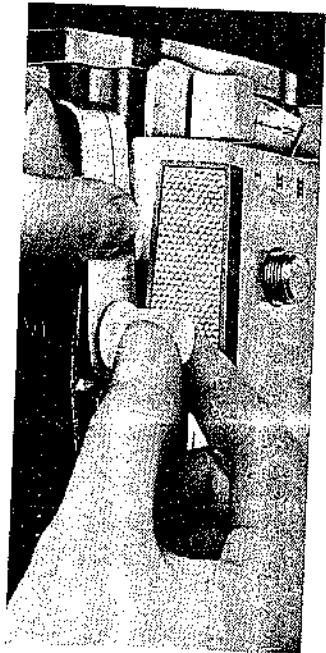

(12) Take out the carriage lock from the accessories box and lock carriage on the left end of the needle bed.

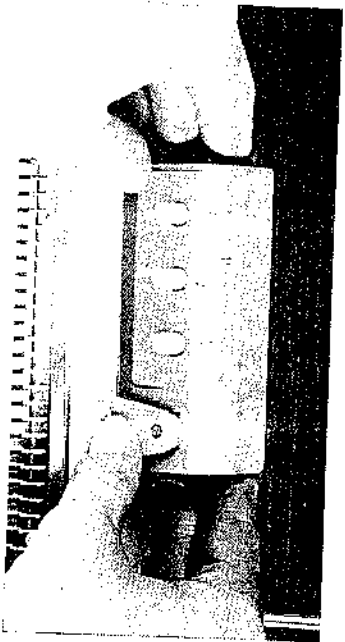

(13) Pull out the row counter.

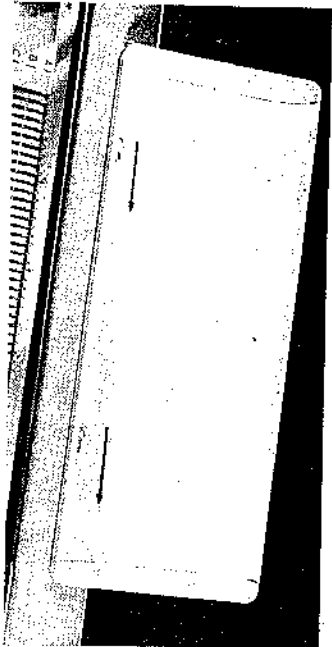

(4) Remove the accessory tray by sliding as indicated by arrows.

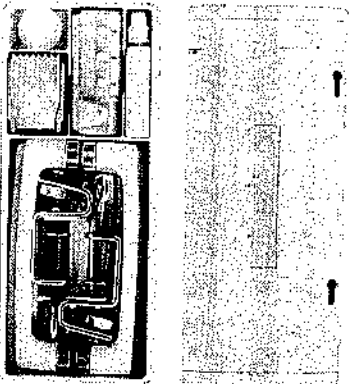

(5) Remove the handle of the carriage, table clamps and set lever. Replace them and other accessories in the accessories box.

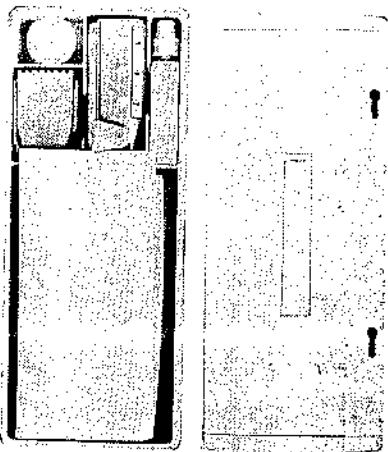

(a) Hold the box with the front up.

(b) Insert the rear foot of the box in the carriage rail.

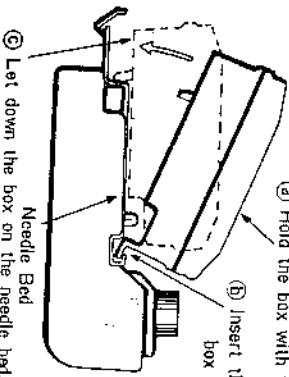

(c) Let down the box on the needle bed.

Needle Bed

(5) Place the box on the right side of the needle bed. The left end of the accessories box must be in line with the number 40 needle.

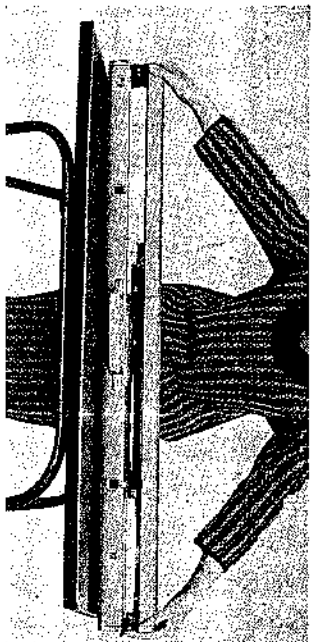
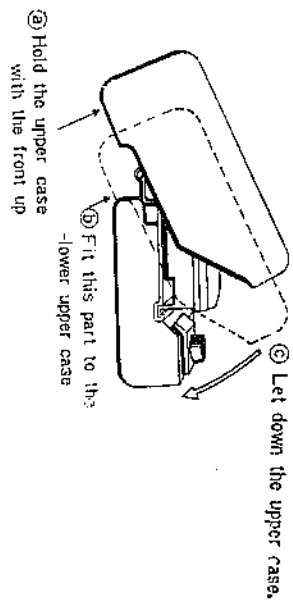
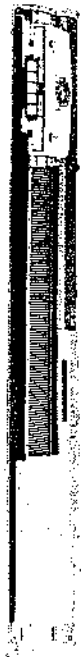
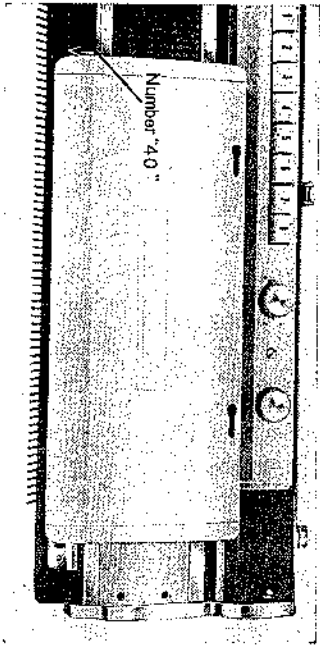

(b) Close the carrying case. Lock the two catches.

WORLD-WIDE SALES AND SERVICE NETWORK

Brother sales outlets and service centers are located strategically throughout the world to give every possible service to our customers.

Brother is represented in foreign countries by Brother International Corporation. (Head Office, 6, 3 chome, Kyobashi, Chuo ku, Tokyo.)

PRINCIPAL OVERSEAS OFFICES

- ① NEW YORK
Brother International Corp.
680 Fifth Ave., New York, N. Y. 10019
- ② LOS ANGELES
Brother International Corp.
431 Crocker Street, Los Angeles, Calif. 90013
- ③ CHICAGO
Brother International Corp.
900 Lunt Ave., Elk Grove Village, Ill. 60007
- ④ PHILADELPHIA
Brother International Corp.
11500-D Roosevelt Blvd., Philadelphia, Pa. 19116
- ⑤ NEW ORLEANS
Brother International Corp.
2809 North Robertson St., New Orleans, La. 70117
- ⑥ DE PUERTO RICO
Brother International Corp.
C. P. O 3713, San Juan, Puerto 00936
- ⑦ MONTREAL,
Brother International Corp. (Canada) Ltd.
863 Montee de Liesse Road, Montreal 9.
- ⑧ VANCOUVER
Brother International Corp. (Canada) Ltd.
1120 Hamilton St., Vancouver, B. C.
- ⑨ DUBLIN
Brother International Corp. (Europe) Ltd.
Santry, Dublin-9, Ireland
- ⑩ LONDON
Brother International Company (U.K.) Ltd.
Mercury House, 30 Alfred Place, London, W. C.-1
- ⑪ FRANKFURT
Brother Maschinen-Handelsgesellschaft m. b. H.
6000 Frankfurt/Main, Ginnheimer Strasse 24-26
- ⑫ PARIS
Brother France
59, Bd Sébastopol et 2, Rue du Cygne

M E M O

[Blank lined area for memo content]

[Blank lined area for memo content]