

**Instruction manual
for knitting machine
Model KH-820**

37
36
35
34
33
32
31
30
29
28
27
26
25
24
23
22
21
20
19
18
17
16
15
14
13
12
11
10
9
8
7
6
5
4
3
2

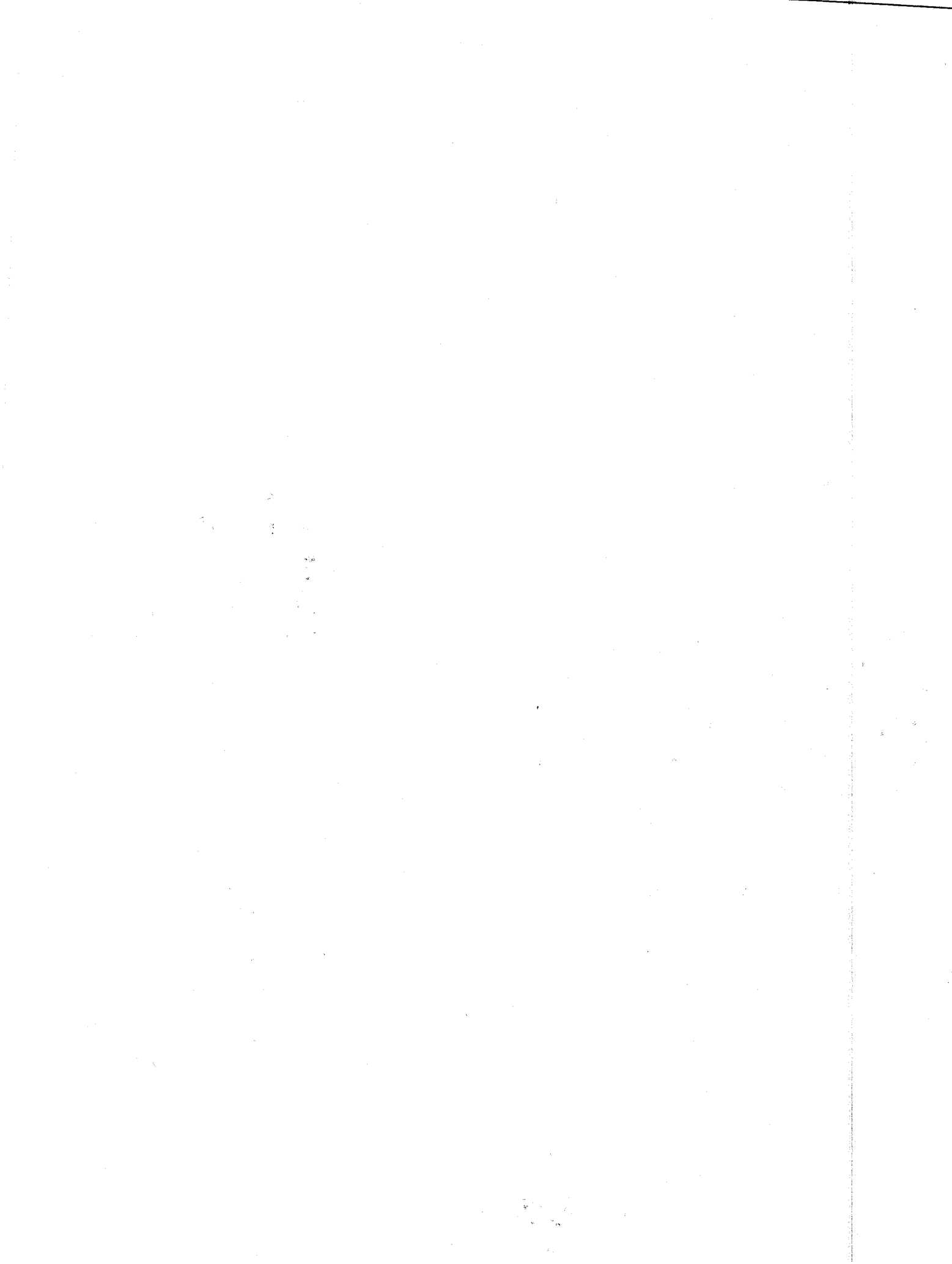

I N D E X

Name of parts	1
Setting up your machine	3
Setting up the carriage	5
Assembling the yarn tension	6
Important points to remember before you start knitting	7
Winding the wool	7
Tension dial and Needle positions	8
Functions of the carriage	10
Preparing to do the plain knitting	13
If the carriage should jam and how to unravel a row	18
Knitting a plain hem	19
Knitting an elastic hem	21
Automatic casting-on using the Weaving levers	23
Finished edge cast-on (Hand method)	24
Knitting a picot hem	25
Picking up dropped stitches	25
How to use the transfer tool	26
Increasing stitches	27
Transferring to hand knitting needles	28
Decreasing stitches	29
Casting-off	30
Knitted patterns in colour	32
How to use the punch cards	41
Explanation of the Punch card	41
Setting up the punch card	42
Preparation of pattern knitting	44
Tuck stitch patterns	46
Skip stitch patterns	47
Fair-isle patterns	48
Weaving patterns	49
Automatic lace patterns	53
Partial knitting of the Lace pattern	54
Button-holes	55
How to knit a pocket	57
Shaping a "Vee" neck	58
Shaping a round neck and square neck	59
Short row designing	60
How to correct the lace knitting	61
If you did the mistakes in pattern knitting using a punch card, how to correct them	62
Replacing a bent or broken needle	64
Maintenance	65
Folding up the knitter	66
Useful attachment for your knitter	70

Wool Winder

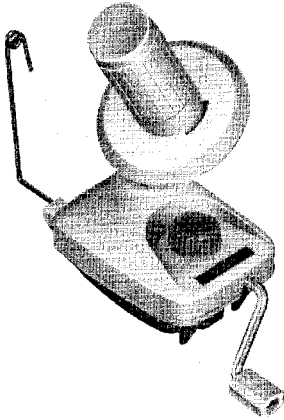

193

Gives you a fine-formed ball of yarn speedily, without hand winding.

Skein Holder

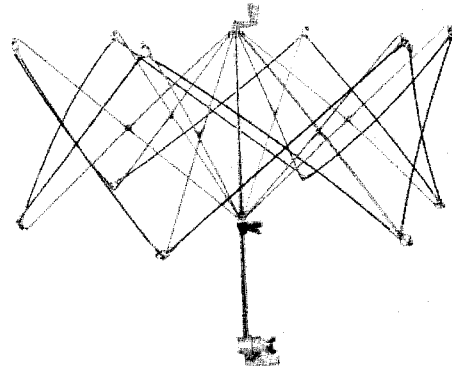

194

Takes skein straight from the store and prepares it for winding the easy way.

Name of parts.....Carriage

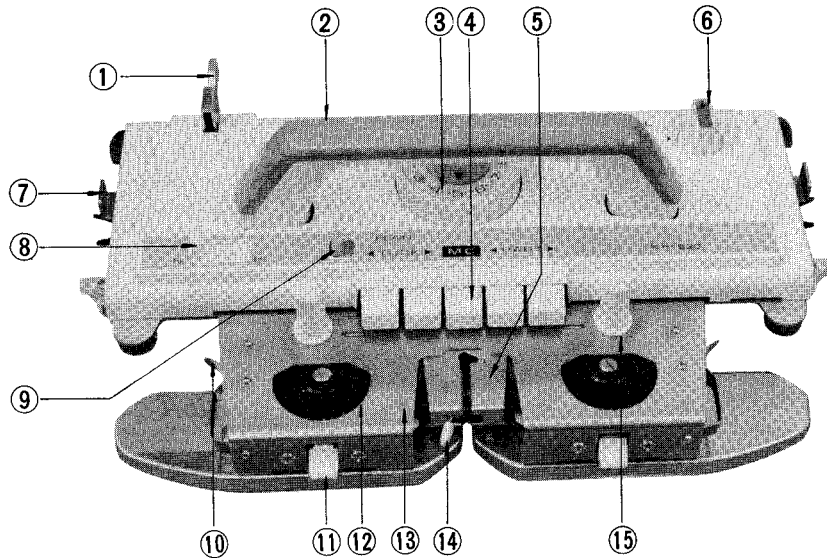

- | | |
|---------------------------|-----------------------------|
| 1. Row counter tripper | 9. Cam button release lever |
| 2. Carriage handle | 10. Weaving yarn guide |
| 3. Tension dial | 11. Weaving pattern lever |
| 4. Cam buttons | 12. Weaving pattern brush |
| 5. Yarn feeder | 13. Sinker plate |
| 6. Change knob | 14. Yarn feeder lever |
| 7. Carriage release lever | 15. Thumb nut |
| 8. Holding cam lever | |

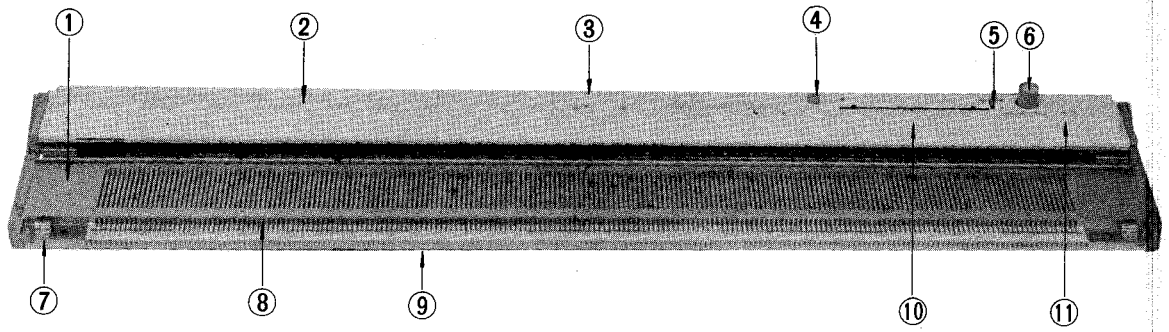

- | | |
|-----------------------------------|----------------------------------|
| 1. Needle bed | 7. Extension rail holder |
| 2. Accessories box | 8. Knitting needles |
| 3. Yarn Tension unit setting hole | 9. Gate pegs |
| 4. Push button | 10. Punch card input slit |
| 5. Card lock lever | 11. Carriage direction indicator |
| 6. Card feeding knob | |

Automatic Yarn Tension Unit

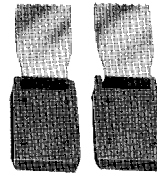
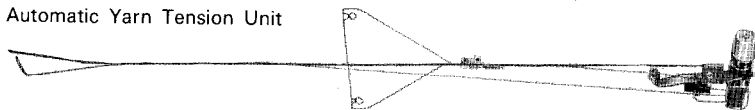

Claw Weights

Extension rails



1/1 Needle Pusher

Cast-on Comb, Short



Cast-on Comb, Long



Latch Tool



2x3 Transfer Tool



1x3 Transfer Tool



Crochet Needle



Spare Needles



Carriage Lock



Wax



Hand Brush

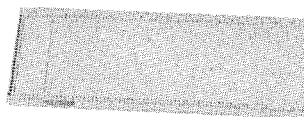

Punch Card set



Table Clamps



Oil



Wax case



Snaps

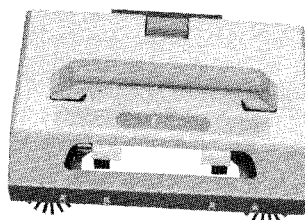

"L" Carriage



Punch card holer pin



Cast-on Thread

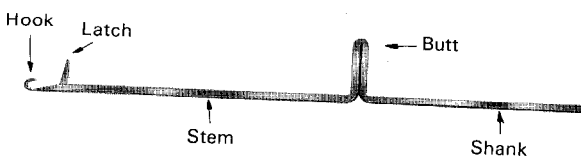

Setting up your machine

1. Place the machine on a firm table, with the Carrying case handle away from you. Unlock the catches on either side of the handle.

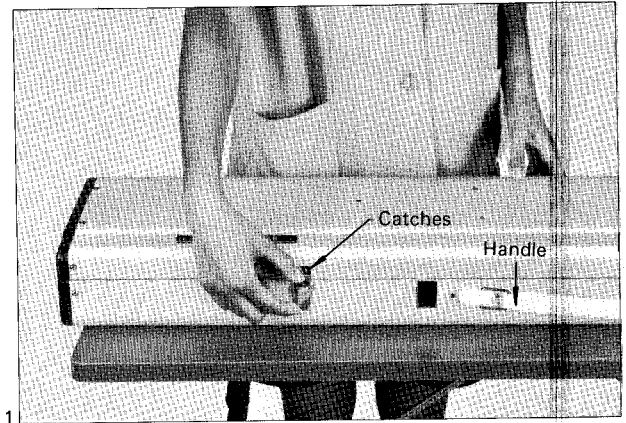

2. Lift the upper case slightly, and pull towards you to release the lid.

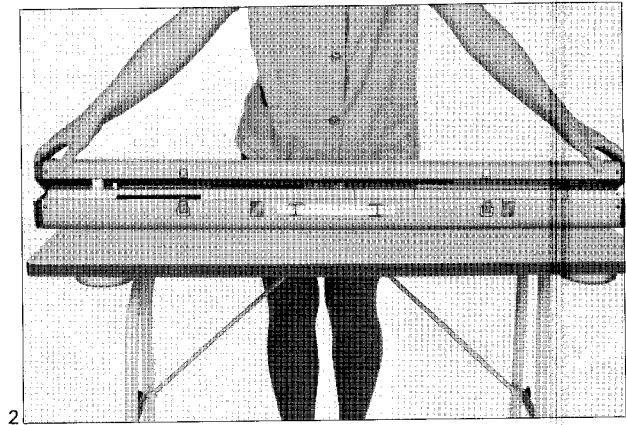

3. Press the knob to right and open the lid of accessory box.



4. Take the two Table clamps out of the Accessory box.

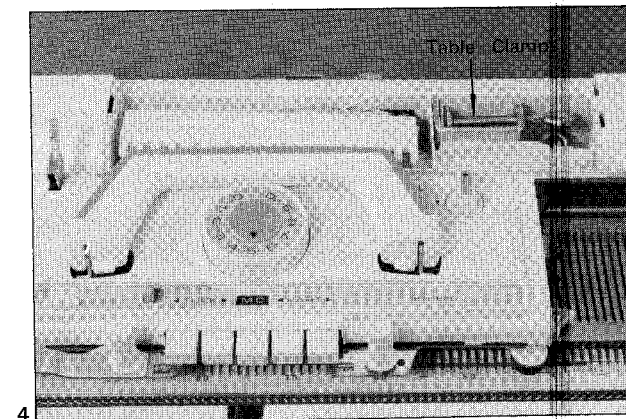

5. Fasten the knitter to the table by tightening the Table clamp screws.

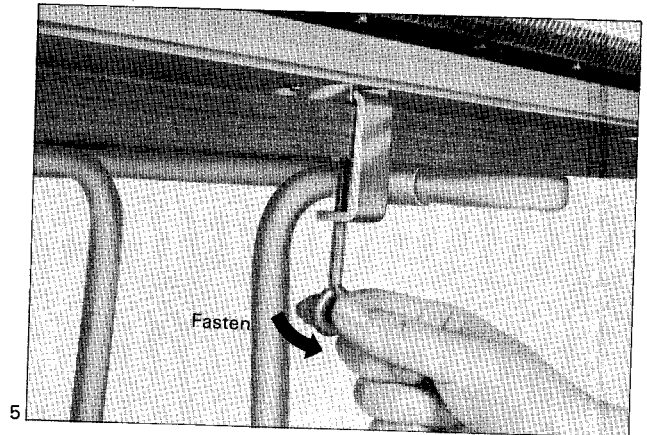

6. Remove the Carriage lock.

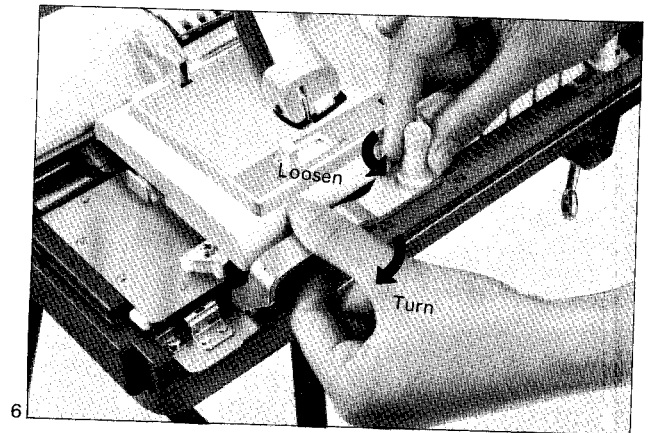

7. Remove the Row counter from the Carrying case.
Pull the Row counter towards you and lift up to remove.

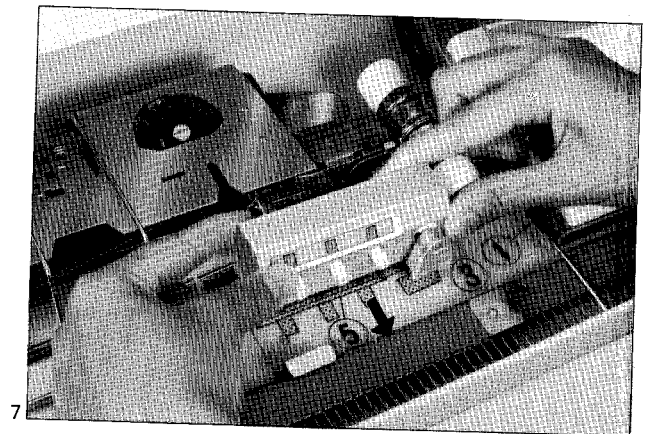

8. Set the Row counter onto the two studs and push it away from you.

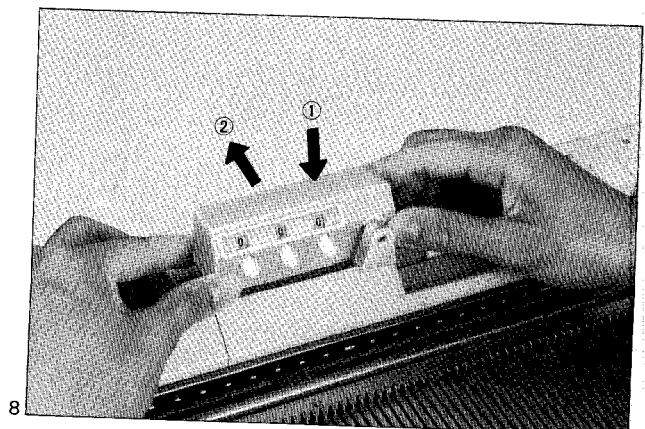

9. Press down the spring in the centre, and remove the Sinker plate assembly.

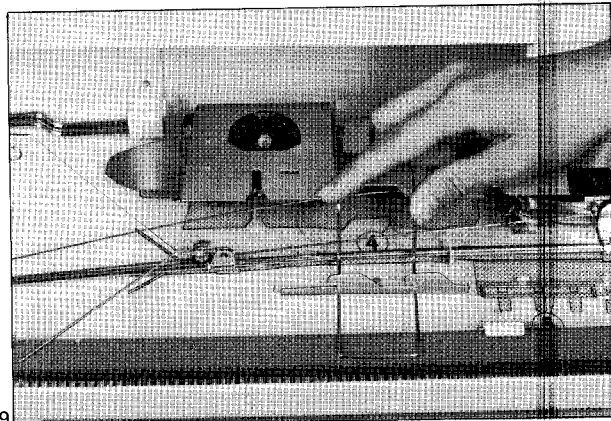

9

SETTING UP THE CARRIAGE

10. Slide the Carriage to the centre of the machine. (Before doing so push back the butts of all the needles as far as they will go.)
Loosen the white plastic thumb screws on the Carriage, and insert the Sinker plate unit. Push it back as far as it will go, and tighten the thumb screws securely. Make sure that the raised metal studs line up with the holes in the Sinker plate unit.

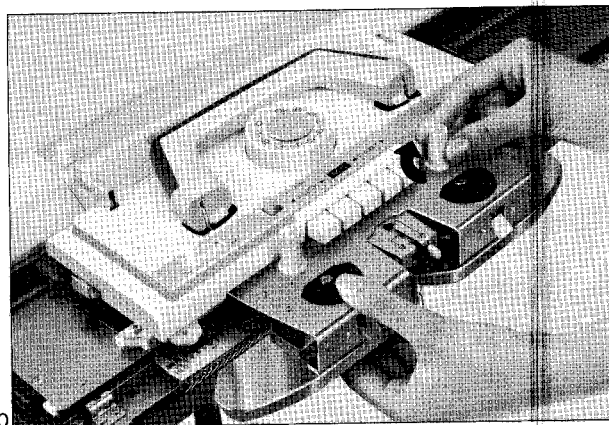

10

11. Pull the Carriage handle towards you and set it up.

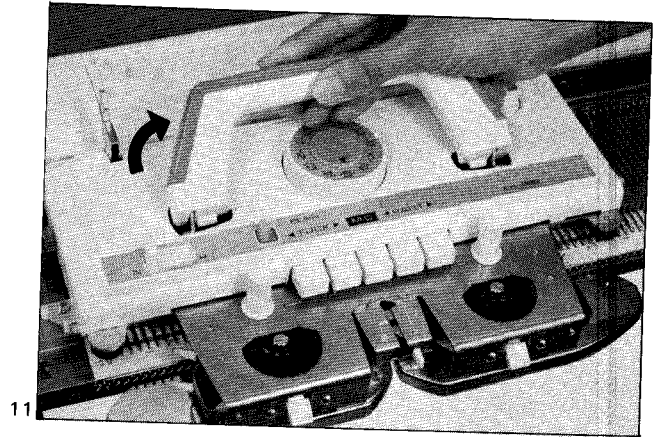

12. Remove the Yarn tension unit from the Carrying case.

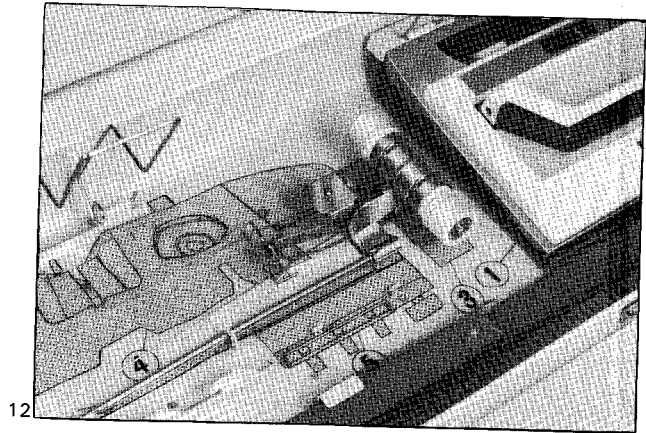

13. Turn the front guide arm forward in the direction of the arrow.

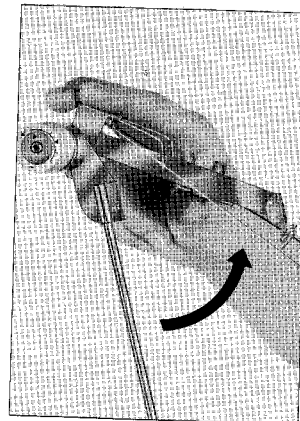

14. Turn back the "Take-up springs" as far as they will go.

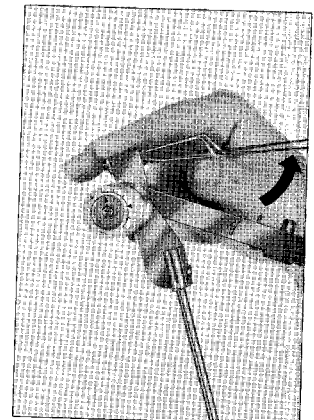

15. Raise the rear guide until it is perpendicular to the rod.

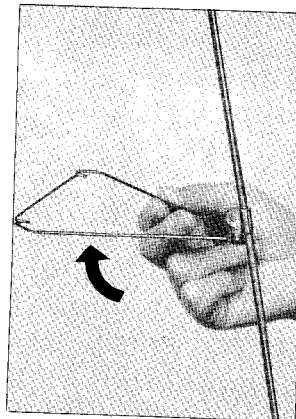

16. Insert the end of the rod into the stand hole at the centre of the machine. The rear yarn guide should face backwards.

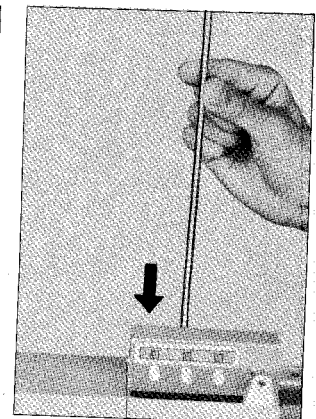

Here are a few important points to remember before you start knitting

WOOL

There are many different types of wool that can be knitted on your machine-but for the purpose of learning or practicing, it is best to use a standard 3 Ply yarn. Choose a good quality, one that can be knitted over and over again.

WINDING THE WOOL

The wool you purchase will be wound in either balls or hanks, both of which unwind slowly when knitted by hand. Machine knitting is much faster, and requires that the wool be loosely wound so that it unravels freely. You should therefore re-wind all wool into a ball, using a wool winder. This way you can also make sure that there are no knots or flaws in the wool-that you might otherwise discover too late. If you do discover any knots, try to ensure that they come at the end of a row and not in the middle of the knitting. (See Fig. 17).

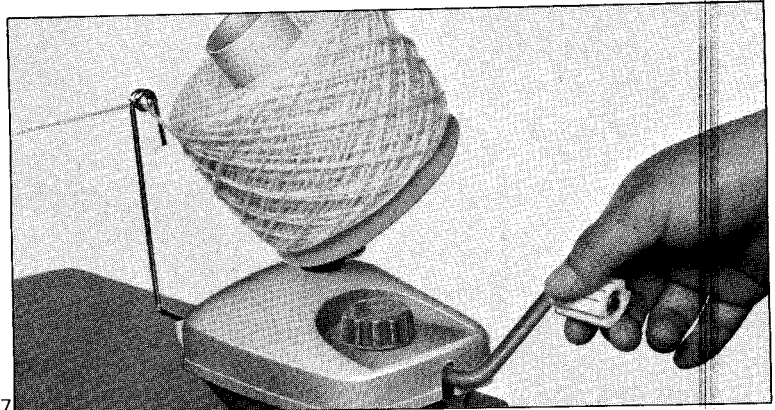

WAXING THE WOOL

For thicker wools or wool of uneven texture it is recommended that you wax the wool before using. To make this easier for you we have built into the Yarn Tension Unit a special wax stand, which automatically applies a small amount of wax to the wool as it passes through the unit. Waxing will smooth the small hairs in the wool, and allow it to run through the machine easily. All traces of the wax will disappear after the garment is pressed. (See Fig. 18).

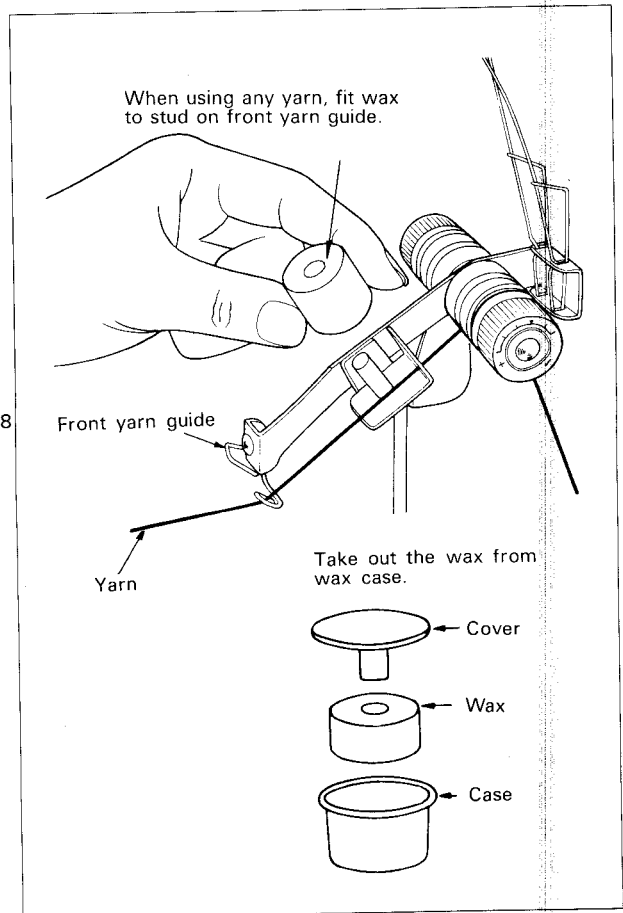

WOOL TENSION

The tension that the wool will feed into the machine is governed by the unit at the top of the Yarn Tension Unit. The spring discs allow the wool to pass through easily or tightly depending upon the thickness of the wool. A tight tension (towards the +) is used for thin yarns and a loose tension (towards the -) for thick wools. The tension we recommend for a 3 Ply wool is where the two arrows meet. (See Fig. 19).

TENSION DIAL

The size of the stitch is determined by the tension setting on the Carriage tension dial. This dial is graduated from 0 to 10, each space being subdivided into three parts. 0 denotes the tightest tension (i.e. the smallest stitch) and 10 the largest tension (i.e. the loosest stitch). The tension at which your garment is to be knitted is usually given in the knitting pattern instructions, but as this is liable to differ for different brands of wool, it is advisable always to knit a tension swatch sample before commencing your garment. (See Fig. 20).

NEEDLE POSITIONS

On either side of the needle bed there appear the marks A, B, D & E. These are the four needle positions. (See Fig. 21).

A—Non working position.

Needles will not knit.

B—Working position.

Used for general work.

D—Pattern knitting position.

Selected needles are brought to this position by the Carriage.

E—Holding position.

The stitch will 'hold' on the needle until released. Used for shaping e.g. pockets and buttonholes.

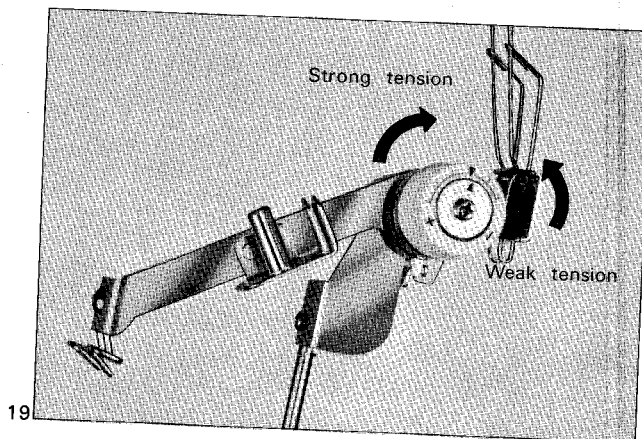

19

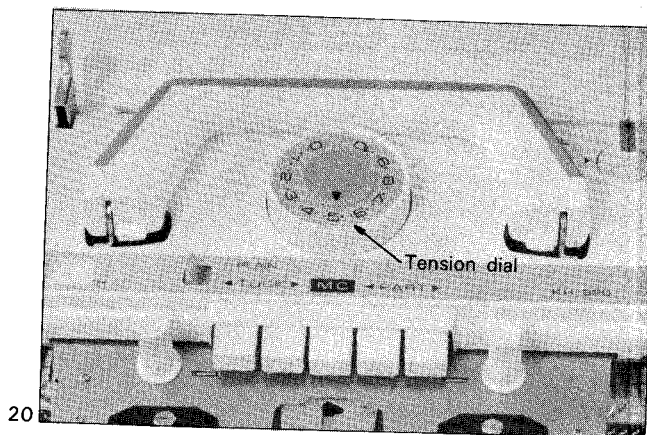

20

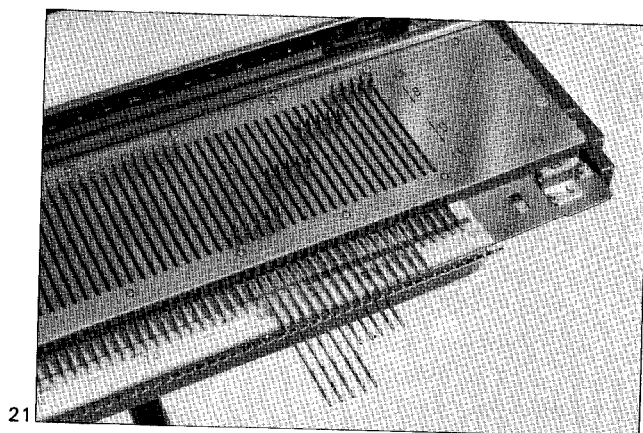

21

IT IS IMPORTANT TO REMEMBER THAT THE CARRIAGE SHOULD NOT BE MOVED ACROSS THE NEEDLE BED UNLESS ALL THE NEEDLES ARE ALIGNED IN EITHER OF THE FOUR POSITIONS.

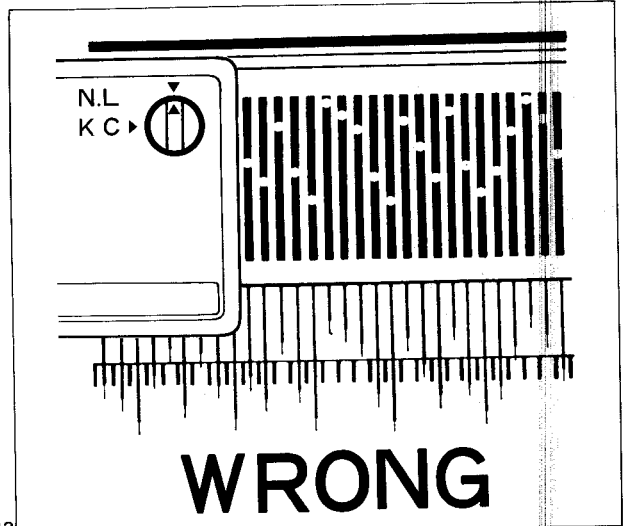

22

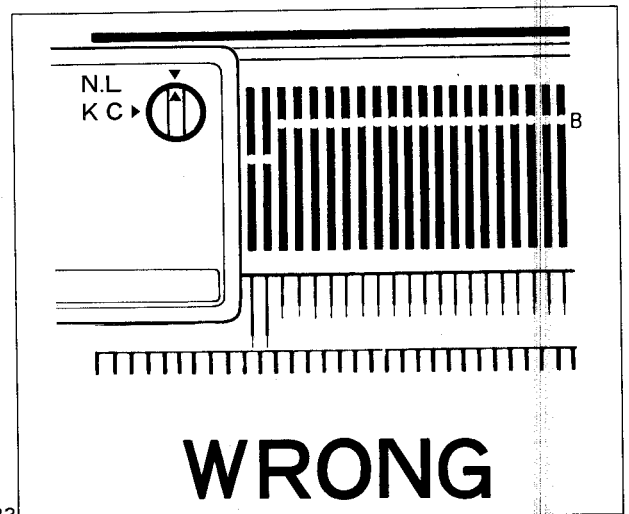

23

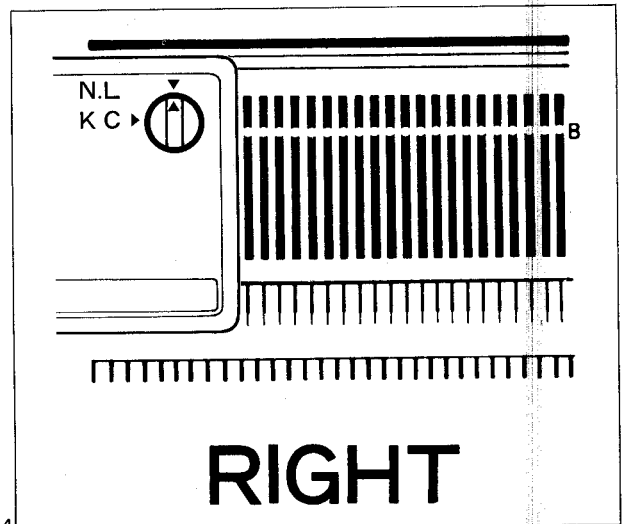

24

Functions of the carriage

10

The movement of the carriage across the needles in action (Position B), automatically knits each needle in turn; thereby knitting one row. Once the carriage has been moved across the needles in one direction, it cannot be returned until that row has been completed. At the end of a row you will hear a "click" from the carriage, which signifies that the row has been completed and you can then return.

It is advisable not to move the carriage too far away from the end needles after completing a row, as this will tend to slacken the tension in the springs on the return movement.

CARRIAGE BUTTONS

There are five buttons and a Release lever on the front of the Carriage.

They are used for various stitch patterns to set the Carriage to enable it to knit various stitches. The arrow above the button shows that the Carriage is set for that direction. If both buttons are depressed together, the Carriage will be set for both directions.

PART—These buttons are used mainly for Skip stitch and similar patterns. If both buttons are in, and the needles are not set, the Carriage will move across needles without knitting the stitches.

MC—This button is used for Fair-isle patterns. This button will work in both directions.

TUCK—These buttons are used to form tucking stitch patterns.

RELEASE LEVER—This lever is pushed to cancel the Cam buttons previously set.

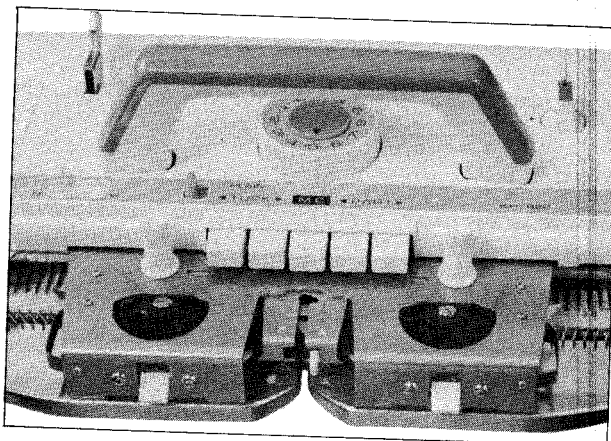

25

HOLDING CAM LEVER

This lever has two positions "N" and "H" and these positions are explained as follows.

N: This is a Normal position.

All needles set forward to D or E positions will return to working position B.

H: This is a Holding position.

Any needles brought forward to position E will not knit if the H.C.L. is on "H". This position is used when knitting a V neck, Round neck, Arm hole and etc.

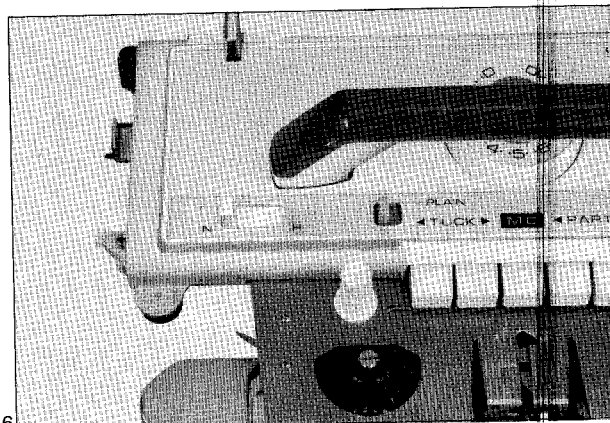

26

CHANGE KNOB

There are two settings on this control.

N.L: This position is used for plain knitting and lace knitting.

No needles are brought forward to position D when this knob is set to "N.L".

K C: This position is used for Punch card needle selection by moving the K Carriage.

Special Note:

Please set this knob to arrow mark of each position definitely.

Don't stop this knob half way between each position.

For lace knitting, the Change knob must be set to "N.L" position.

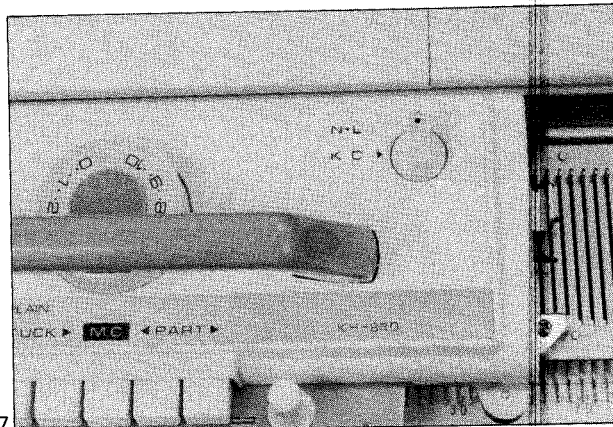

27

CARRIAGE RELEASE LEVERS

There are two Carriage release levers on the carriage—right and left.

If carriage jams, open both levers as far as they will go to remove the Carriage.

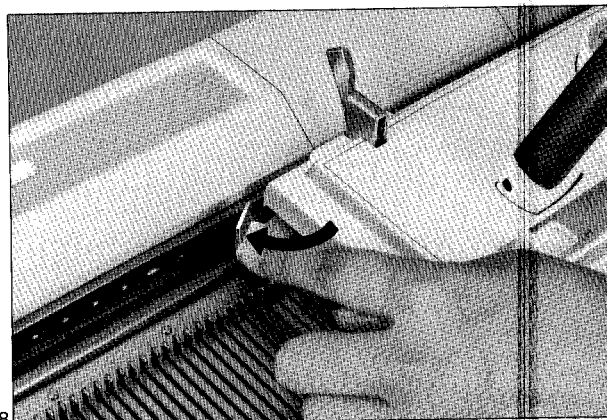

28

WEAVING LEVERS

These levers are used for Weaving patterns.

N : Lower position is normal position.
W.T: Upper position is weaving pattern position.

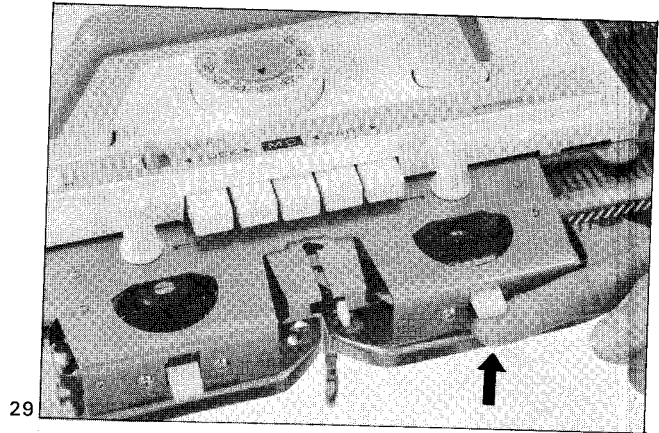

29

ROW COUNTER

The figures on your row counter can be moved to zero by turning the dials according to the arrows in order from the left.

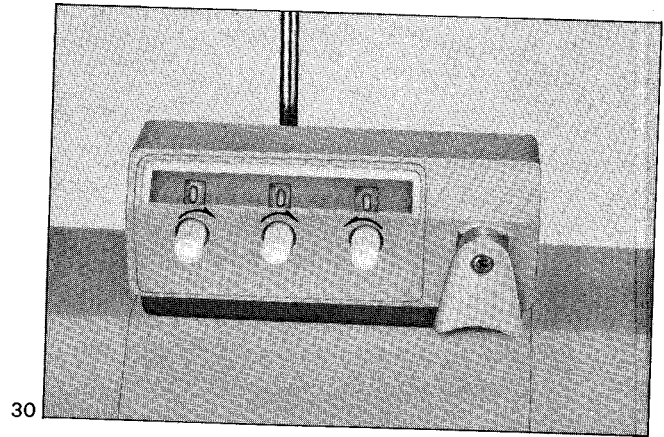

30

When using the row counter, set the tripper to working position.
If you do not wish to use the row counter, then pull the tripper back to resting position.

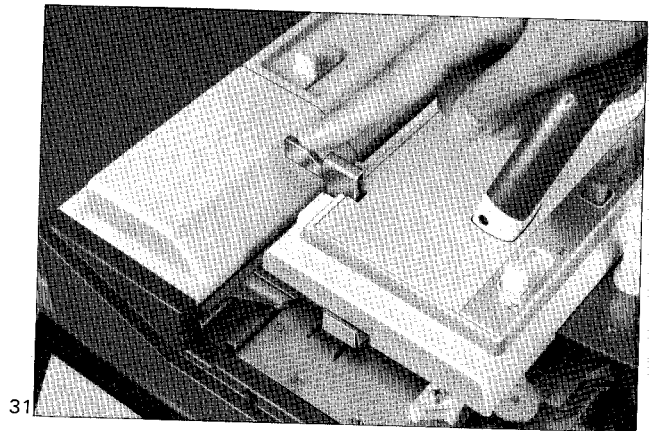

31

Preparing to knit

STEP ONE—

The Carriage.

The photo shows the various controls of the Carriage that you should remember.

- (1) Set the tension dial to 5 for medium thickness yarn. (Ex. 3 ply)
- (2) Set both weaving levers to N.
- (3) Set the change knob to N.L.
- (4) The Holding cam lever to N.
- (5) Push the Cam button release lever to release the buttons for plain knitting.

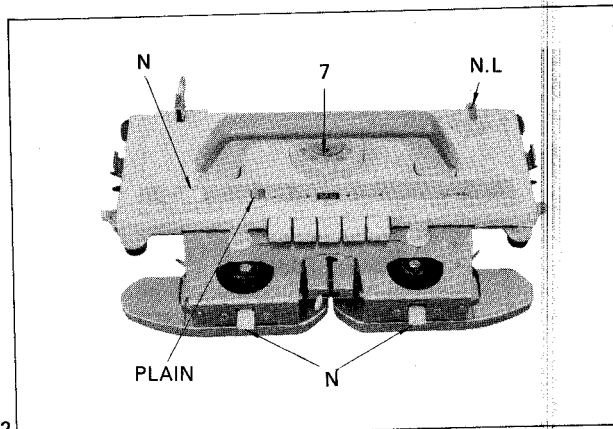

32

STEP TWO—

The Needle Bed.

- (1) Bring forward by using the needle pusher provided in the accessories box 60 needles to position B, 30 needles on either side of the centre mark "O".
- (2) Move the Carriage across and back to straighten these needles into B position completely.
- (3) Place the Carriage at right hand side of the needle bed.

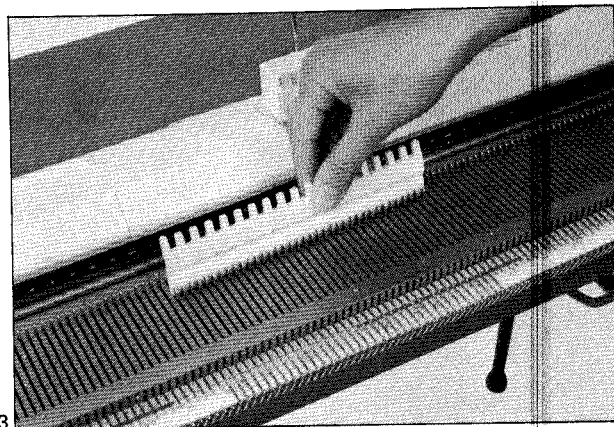

33

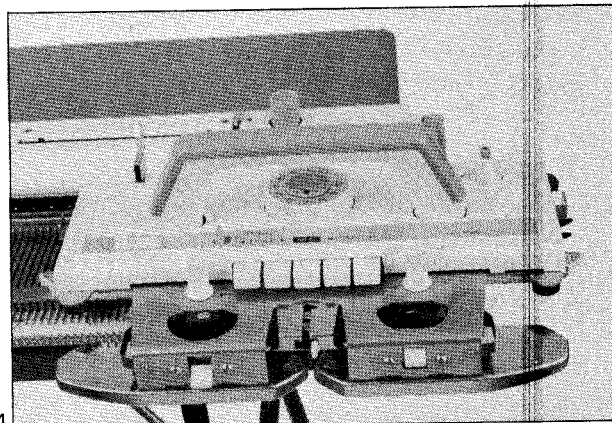

34

STEP THREE—

Threading the Yarn tension unit.

- (1) Pass the yarn from the ball through the Rear yarn guide as shown in fig. 35.

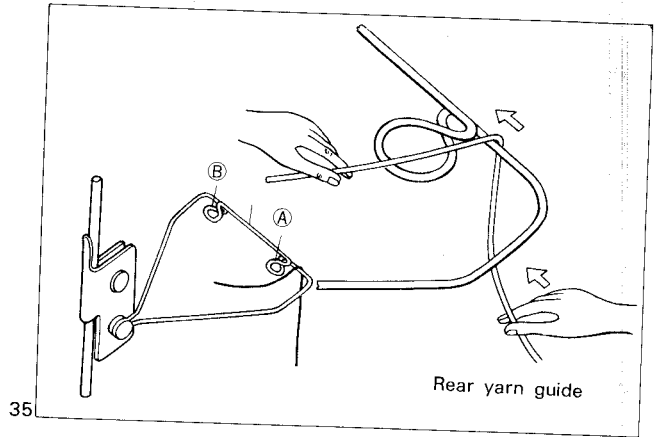

- (2) Pass the yarn under the pin and through between two discs, from behind. (See Fig. 36).
- (3) Thread the front yarn guide. Meet the arrow mark for medium thickness yarn. (See Fig. 36).

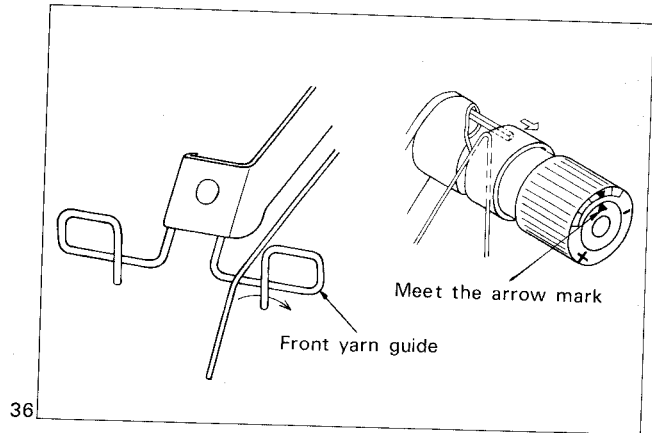

- (4) Thread the yarn into the eyelet of the Take-up spring and clip the yarn under the Yarn clip.

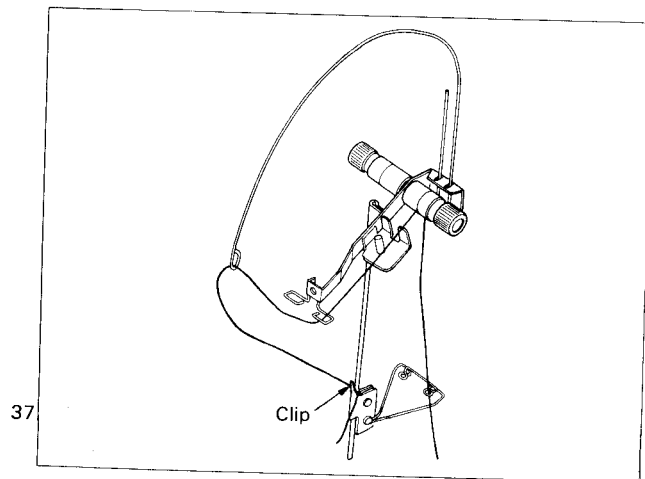

STEP FOUR— CASTING ON.

(1) Hold the cast-on comb, with the wire hooks facing you, and turn securing levers at both ends to face you. Place hooks between the pegs of needle bed as far up as possible, then turn the two securing levers on comb outwards and the cast-on comb will hang correctly on the knitter.

Use the small cast-on comb and centre it between the 50th needle on the right and left. SET THE TENSION DIAL TO No. 5 (for 3-PLY YARN) See Figs. 38 to 41.

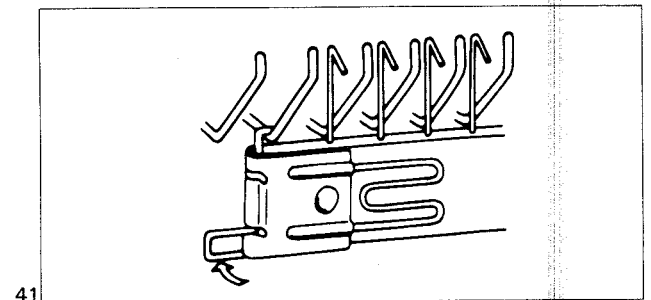
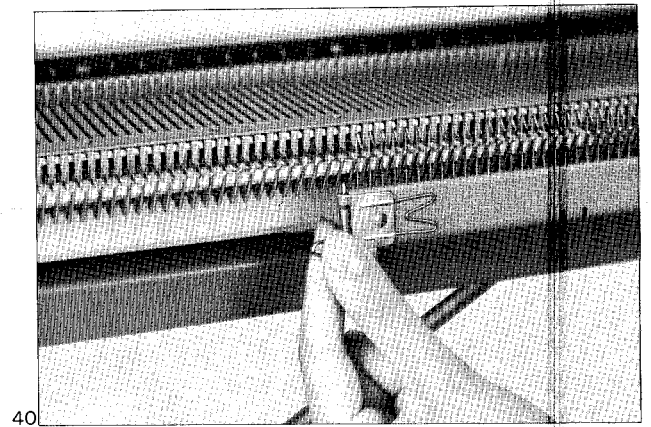
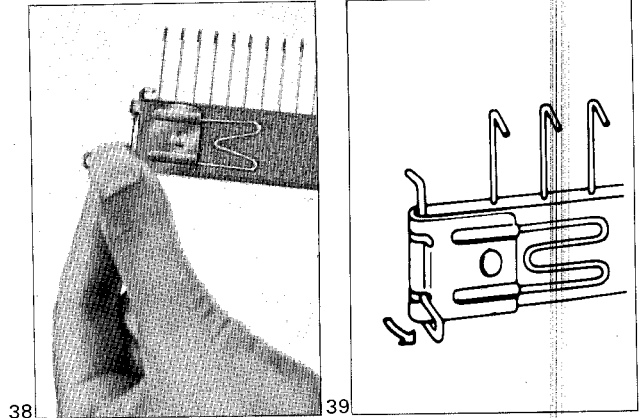

(2) Turn the Yarn feeder lever to left and take the end of the yarn (which was clipped onto the yarn tension rod) and thread it into the yarn feeder "A" for main yarn. Then close the yarn feeder lever. (Fig. 42)

Hold the yarn from below with your left hand and from above with your right.

*The Yarn feeder "B" is used only for Fair-isle pattern knitting which is explained further on.

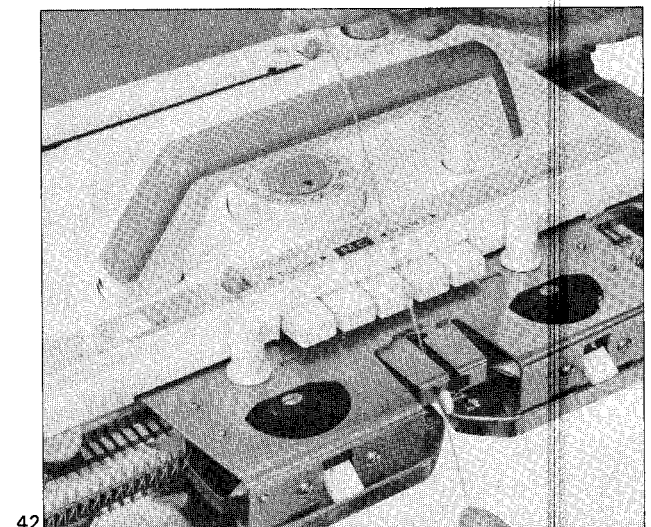

(3) Continue to hold the yarn below with your left hand, and take back any slack yarn through the yarn tension unit (i.e., the take up spring should be bent forward).

(4) Still holding the yarn below the Carriage with your left hand, slide the Carriage across the needles with your right hand until you hear a "click".

N.B. Always move the Carriage across until you hear the click at the end of a row.

You will now have a loop around each needle and under each peg of the comb.

If a few end needles have been pulled forward from position B then simply push them back by hand before continuing.

(5) You can now lower the cast on comb by turning the end pegs (at the same time) towards you. This will release the comb from the gate pegs and you can allow it to drop slowly.

Note: The cast-on loops are still loose so take care not to turn the comb out of a vertical position or the loops may fall off.

(6) Raise the yarn from the comb to the Carriage, so that it goes under the last comb peg, adjacent to the end needle and above the rest. (Fig. 46)

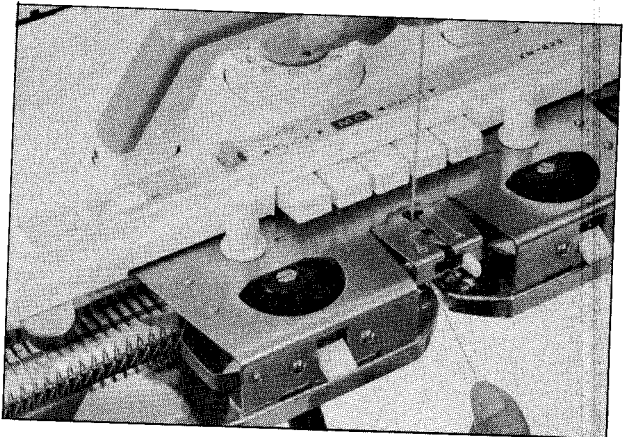

43

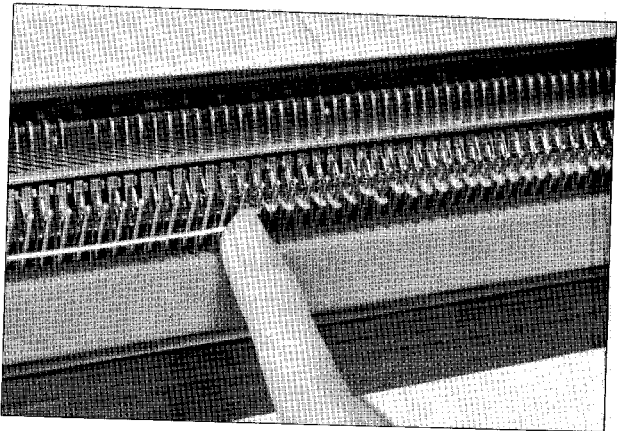

44

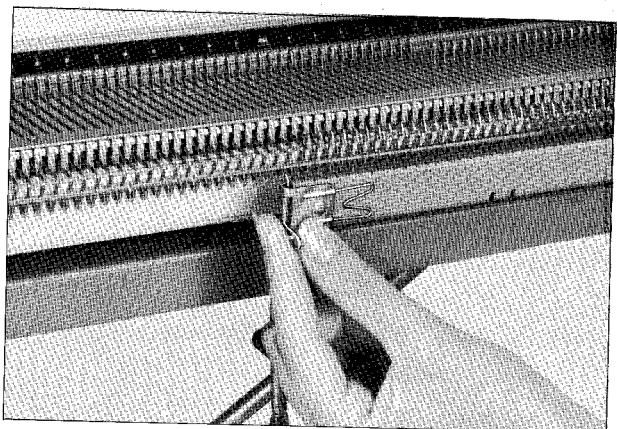

45

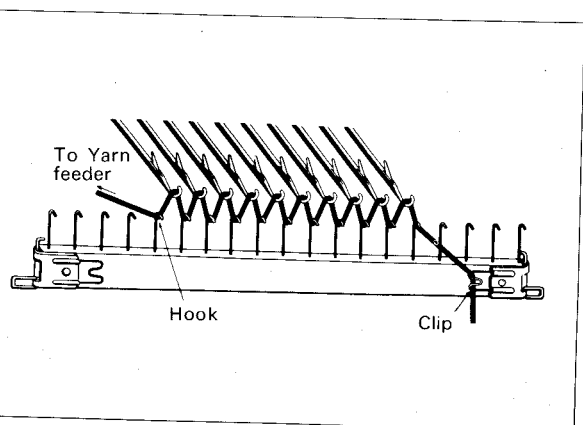

46

(7) Knit the next row slowly and continue knitting. The cast-on comb can be removed after the first 6 or 8 rows by tilting it backwards. After a few rows, remove the knitting from the machine (i.e., taking the yarn out of the Yarn feeder and move the Carriage across the needles). Practice this cast-on two or three times.

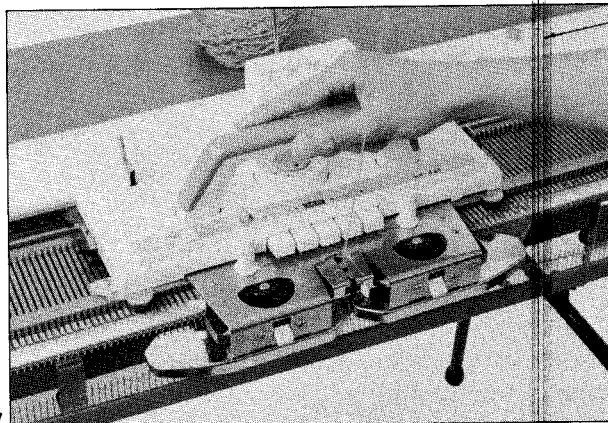

47

YOU ARE NOW ABLE TO DO A QUICK OPEN END CAST-ON. THIS METHOD IS NOT USED WHEN PRODUCING GARMENTS, BUT IS USEFUL FOR KNITTING SWATCH SAMPLES AND EXPERIMENTING.

ALTERNATE METHODS OF CASTING ON ARE GIVEN FURTHER ON.

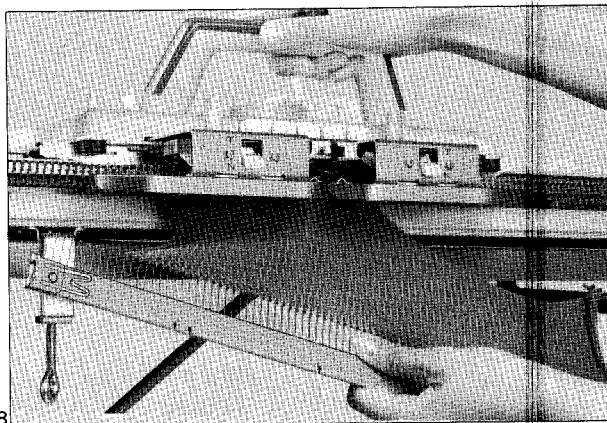

48

The purl side (or wrong side) of the knitted fabric (facing you) looks like right picture. (Fig. 49)

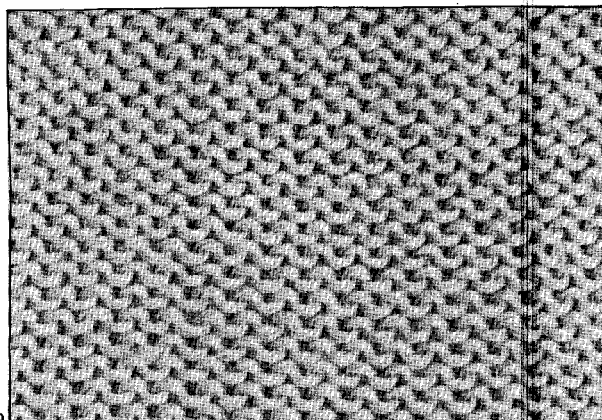

49

The plain side (or right side) of the knitted fabric (away from you) will look like right picture. (Fig. 50)

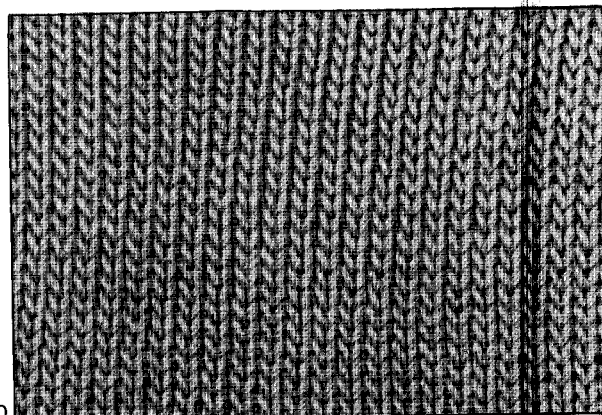

50

IF THE CARRIAGE SHOULD JAM AND HOW TO UNRAVEL A ROW

- (1) Loosen the thumb screws of the sinker plate and remove the sinker plate from the Carriage.
- (2) Turn the Carriage release levers as far as they will go, and holding the handle, lift the Carriage up. Then, place it back to the side from where that row commenced.
- (3) With the yarn still in the yarn feeder, return the sinker plate to the carriage and tighten the thumb nuts securely.
- (4) Unravel the last row of knitting. (See below)

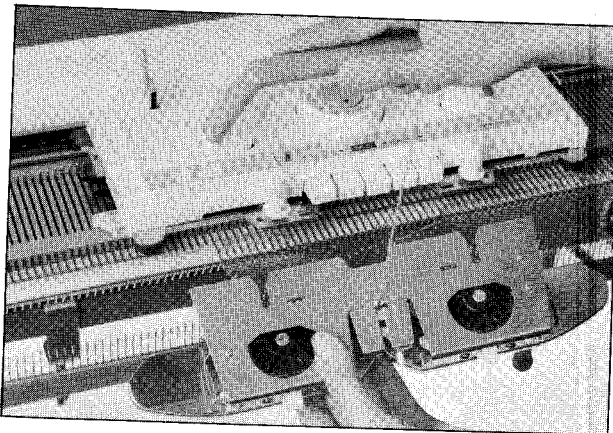

51

UNRAVELLING A ROW OF KNITTING

- (1) Pull the yarn slightly sideways and up. (See Fig. 52). The stitches will come off the needles and the stitches from the row below will slip onto the needles.
- (2) Continue to pull the yarn sideways and up removing 4 or 5 stitches at a time until you reach the spot where the carriage was jammed.
- (3) Pull the yarn down from the rear (above ball) to take up the slack and to bring the take up spring back into action.
- (4) Ensure that there is no slack from the carriage to the needles by sliding the carriage left and right a few inches (NOT ACROSS NEEDLES IN ACTION). (See Fig. 54).
- (5) ADJUST THE NUMBERS ON YOUR ROW COUNTER.

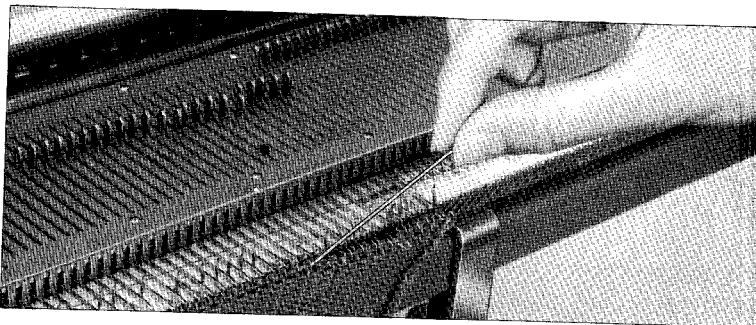

52

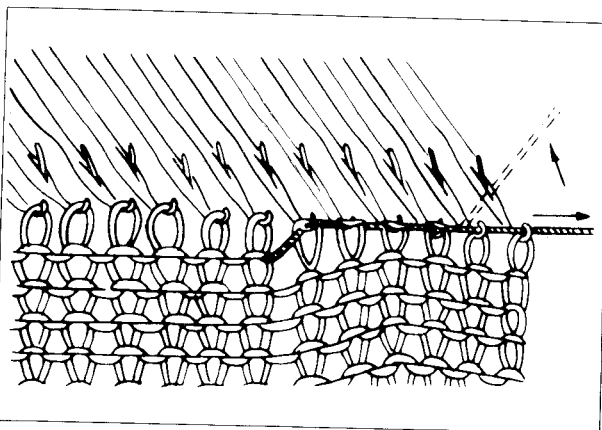

53

IF YOU FIND IT NECESSARY TO MOVE THE CARRIAGE ACROSS THE NEEDLES IN ACTION WITHOUT KNITTING A ROW Then press both PART buttons in at the same time and set the H.C.L. to H. If any needles have been selected then put them back to B position before going across with the carriage.

IF YOU ARE KNITTING USING THE PUNCH CARD, PLEASE REFER TO "HOW TO CORRECT THE MISTAKES" ON PAGE 62.

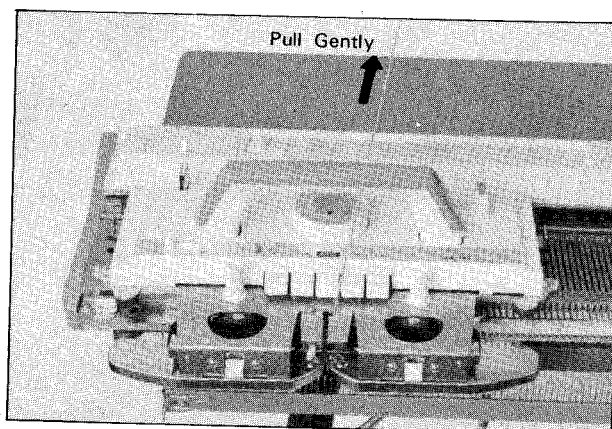

54

Now let's knit a plain hem

BEFORE CONTINUING: LET'S LOOK HOW A STITCH IS FORMED.

- (1) The stitch is on the needle which is behind the gate pegs.
- (2) The carriage brings the needle forward by pushing the needle butt.
- (3) The stitch pushes the latch back and falls behind it.
- (4) The new thread (from the yarn feeder on the carriage) is laid into the needle hook.
- (5) The carriage brings the needle back and so doing the previous stitch gets pushed forward again—this time right over the latch (by-passing the hook).
- (6) The newly laid thread gets pulled in to form another stitch.

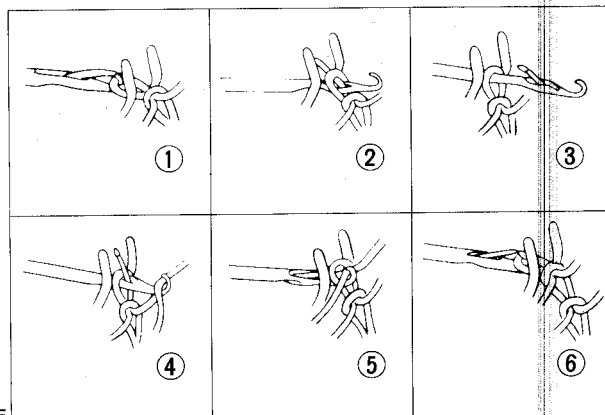

55

LETS KNIT A PLAIN HEM.

Bring forward the required number of needles (evenly divided on either side of the centre 'O') to working position B. Slide the carriage across these needles to straighten the needle butts.

CARRIAGE SETTING

Cam Button—PLAIN.

H.C.L.—N.

Change knob N.L.

Tension Dial—7 (3-ply wool). Carriage on the right.

MACHINE SETTING

Thread the yarn tension unit using waste wool (or any contrast colour yarn). Cast on (as previously shown using the cast on comb) and knit 8 or 10 rows plain. Remove the cast on comb from the knitting.

- (1) Tighten the tension by two numbers (i.e., 5)
- (2) Thread the waste wool below the yarn feeder and re-thread the machine with the wool to be used.
- (3) Set row counter back to '0'.
- (4) When the yarn is threaded into the carriage hold it below with one hand and knit across with the other.

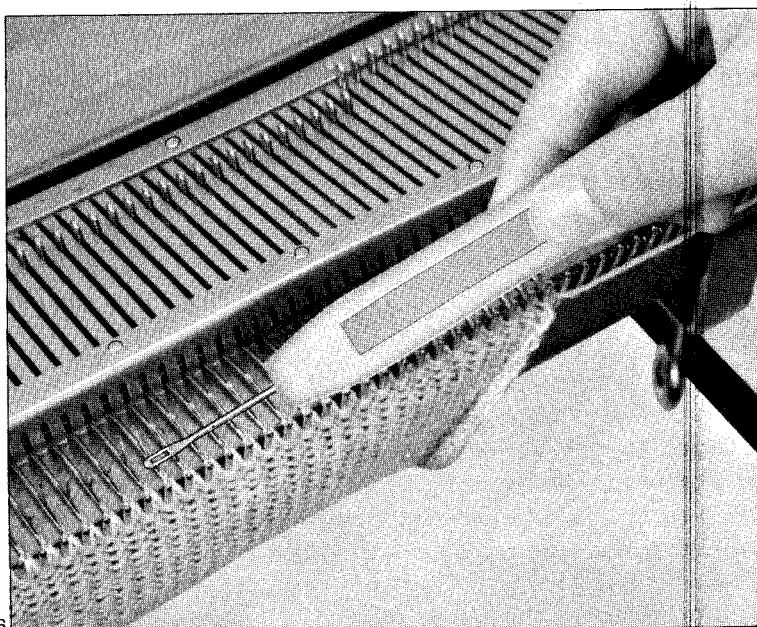

56

- (5) Knit approx. 20 or 30 rows or as required for double the depth of hem.
- (6) Using the single eyed transfer tool open the latches of the needles as shown (refers to Fig. 56).

TURNING THE HEM

Pick up the first stitch (away from carriage) of the first row where it meets the contrast colour row. (N.B. DO NOT PICK UP THE CONTRAST COLOUR STITCH). Insert the transfer tool into this stitch and lay the tool over the hook of the needle.

(2) Hold the work forward with your left hand and pull the transfer tool back and up with your right. This brings the needle forward to E Position and slips the stitch from the tool onto the needle. (N.B. If you intend to do the next row in a pattern stitch that required the needles to be in B Position —then do not pull the transfer tool back, but simply raise it upwards so that the stitch falls onto the needle.

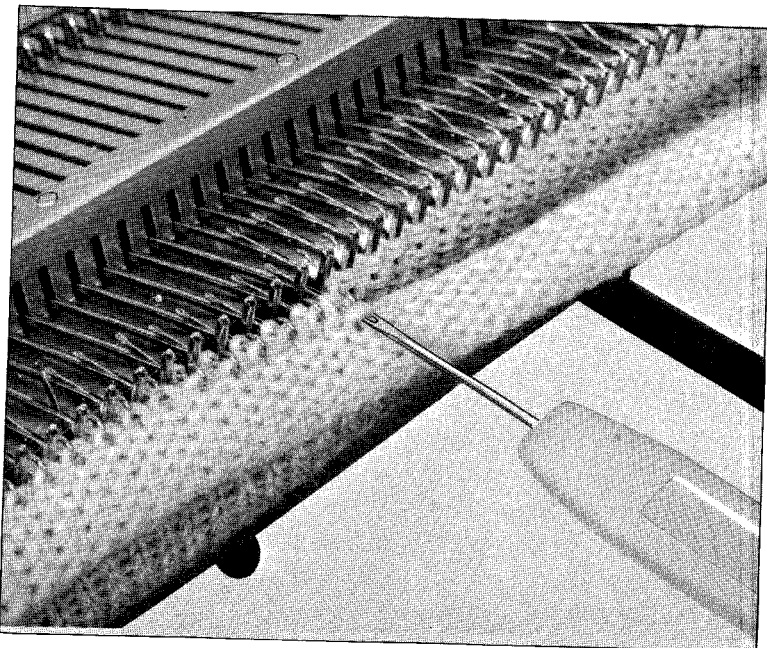

Make sure that the needle does not come forward enough for the two stitches to fall behind the latch).

(3) Continue raising the first row of stitches in this manner until all the needles have two stitches on them.

(4) Reset the tension dial to 7 and take up any slack in the wool from the knitting to the carriage.

(5) Knit 1 row (closing Hem), reset to main tension and continue knitting garment.

REMOVING THE WASTE WOOL

Once the garment has progressed few inches you can remove the waste wool by breaking the end stitch of the row joining the knitting and pulling the loose thread at the other end of this row.

Now lets try an elastic hem (i.e. continental or double 'rib')

Using the 1/1 needle pusher, bring forward the required number of needles to B position. (Bring every alternate needles forward to B position). The other needles must be in A position. And move the carriage across and back to align all the alternate needles in position B.

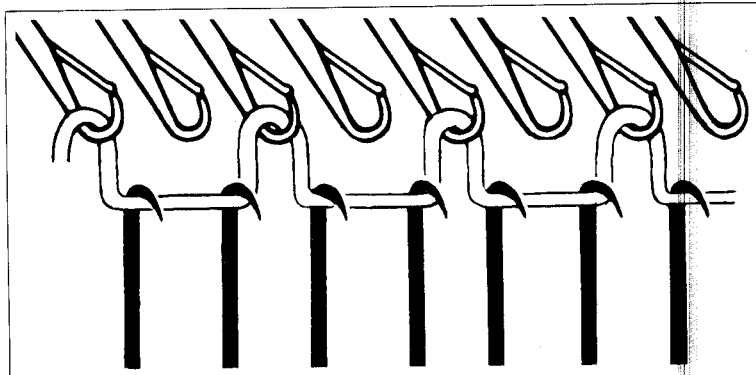

58

- (1) Thread up and cast on with waste wool as before. (When the comb is dropped it should catch the first row as illustrated in No. 58).
- (2) After knitting 8 or 10 rows of waste wool break the wool and re-thread with the wool to be used. Lower the tension by 2.
- (3) Knit approx. 40 or 50 rows. (See Figs. 59 and 60).
- (4) Bring forward all the empty needles from Position A to Position B, by hand and make sure that all the latches are open.

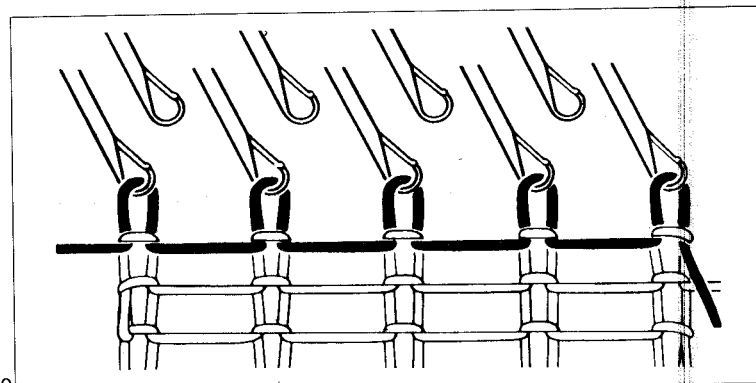

59

- (5) Using the one eyed transfer tool and starting from the end opposite the carriage pick up each stitch from the first row (where it joins the waste wool) and raise these onto the empty needles. (See Fig. 61).

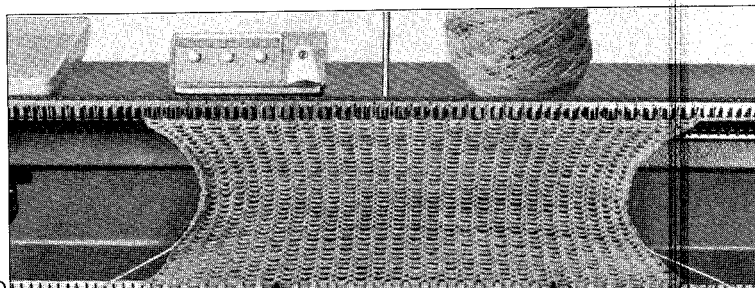

60

(NOTE: As explained under 'plain hem' when raising these stitches the needles can be brought forward to E Position to ensure that the stitches do not drop off—or they can be left in B Position).

- (6) Return the Tension dial to main tension and after knitting a few inches the waste wool can be removed.

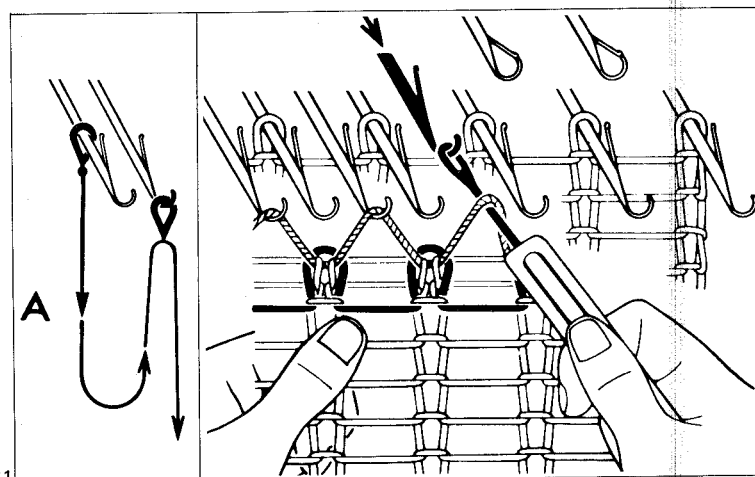

61

**THE FINISHED
"DOUBLE RIB"
SHOULD LOOK LIKE
THIS**

(See Fig. 62).

MANY variations of this elastic rib can be made for cuffs and hems. One of the more popular is the 2×1 Double Hem—the instructions of which are given here.

(1) Bring forward the required number of needles to B Position and push back every third needle to Position A (out of action). (See Fig. 63).

(2) Follow the previous instructions for the 'continental rib', but when raising the first row of stitches (adjoining the waste wool)—put them onto the adjacent two needles to the left (See Fig. 64).

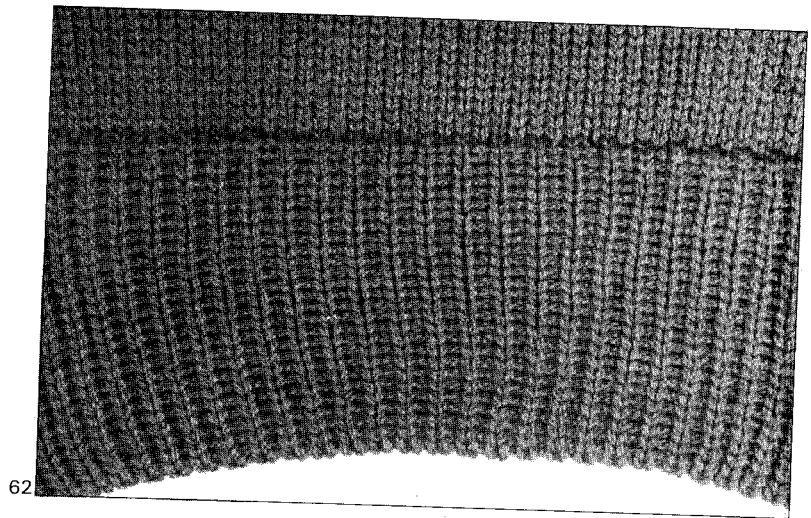

62

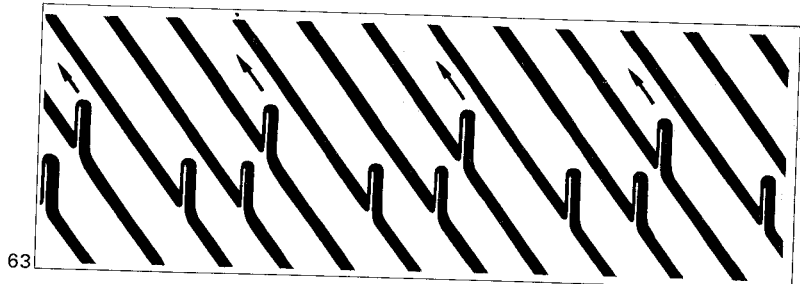

63

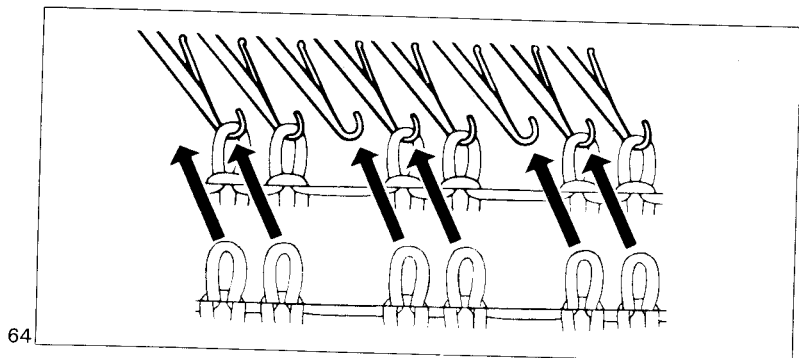

64

**THE COMPLETED
2×1 RIB WILL LOOK
LIKE THIS**

(refers to 65)

So far you have learned to cast on with a double hem—now let's see some other methods of casting-on.

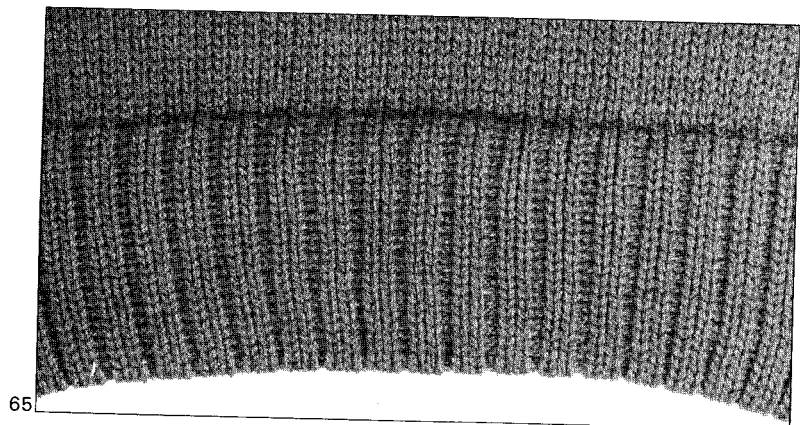

65

Automatic casting-on without using the Cast-on comb(Finished edge)

*Use the Weaving lever and 1/1 needle pusher.

- (1) Bring forward the required needles to B position.
- (2) Set the Carriage as shown in the picture and place it at the right hand side of the Needle bed.
- (3) Using the 1/1 needle pusher, bring forward the needles to D position, and open the latch of these needles.

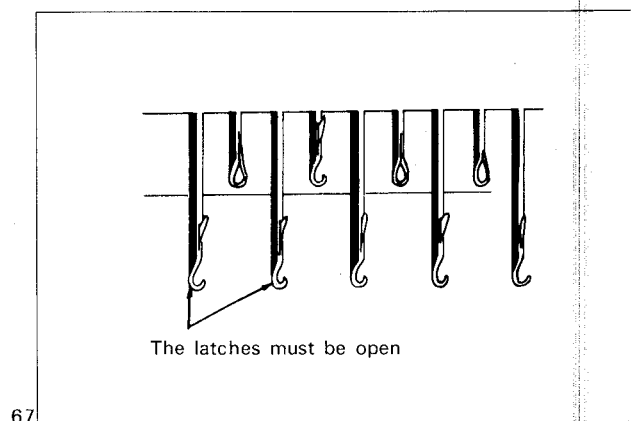
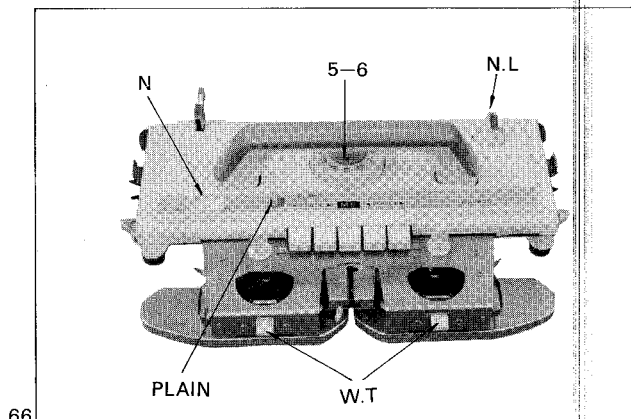

- (4) Thread the yarn into the Yarn feeder "A", and lay the yarn over the selected needles by hand. Hold both ends of the yarn as shown in figure 68.

(5) Pulling down gently with the left hand, and move the Carriage to knit slowly with the right hand.

(6) Continue to hold the end of yarn with the left hand for next few rows.

(7) Return the Weaving lever to N, and release the end of yarn after knitting a few rows.

(8) Now you have a closed edge Cast-on.

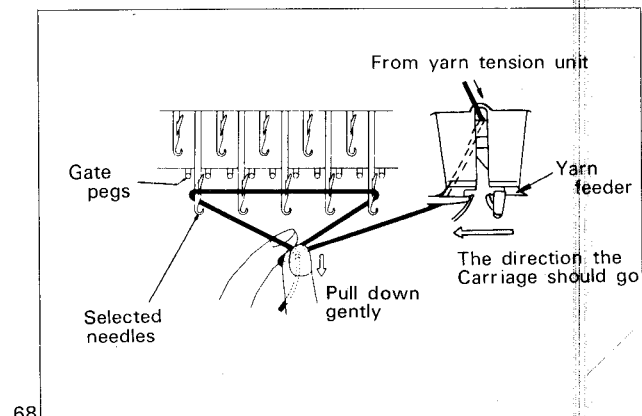

Finished edge cast-on(hand method)

24

Finished Edge Cast on Hand Method

Place the carriage on the right and set the Tension Dial to 5. Hang the cast on comb onto the pegs of the needle gate.

- (1) Bring forward to Position E, all the needles required.
- (2) Fasten the end of the yarn (threaded only through the yarn tension unit) onto the end needle on the left, using a slip knot.
- (3) Loop the yarn around each needle from left to right, counter clockwise. The loops must be pushed back on the stems of the needles. To control these loops as you wind, hold your thumb under the last one before making another. Do not make the loops too tight. (See Fig. 69–70).
- (4) Now thread the yarn into the feeder, and pull the strand (coming from the ball) down, to take up any slack.
- (5) Gently move the carriage to the left to knit the first row.
- (6) Lower the comb onto the stitches and see that the yarn goes above the comb pegs that are not opposite needles in action. Leave the comb suspended until about 10 rows have been completed.

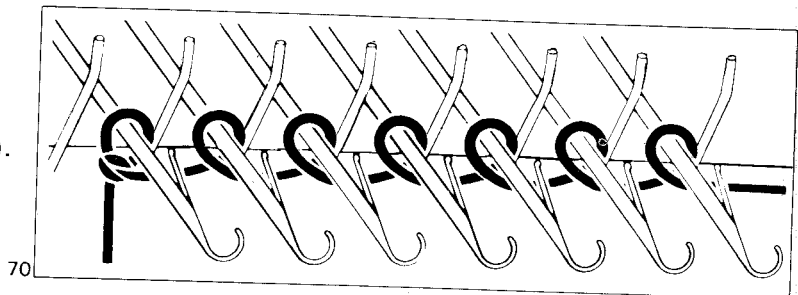
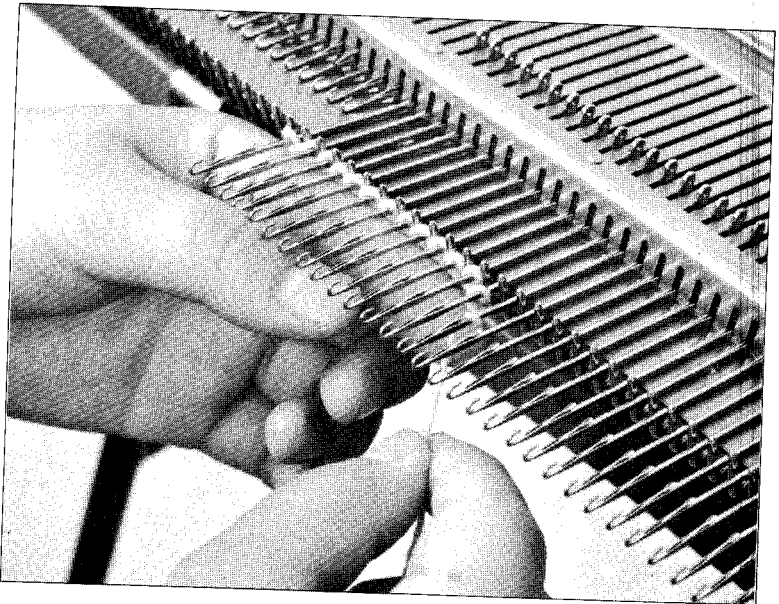

Tube knitting

- (1) Cast-on 3 or 4 needles.
- (2) To get fine finish, use a slightly tight tension.
- (3) Depress right PART button.
- (4) Pull down the fabric by left hand, and move the carriage by right hand.

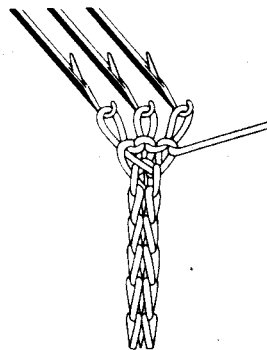

Knitting a picot hem

Picking up dropped stitches

Picot Hem

Set the machine as for the 'PLAIN HEM' and knit up to half the depth of the hem with the Tension Dial two numbers lower than required for that wool (i.e., If the hem is to be 50 rows then knit up to the end of the 25th row, starting from where the main wool joins the contrast colour). Place the Lace Carriage (See section on Lacy knitting) onto the needle bed. Bring forward every alternate needle to D position, using the 1/1 needle pusher. Don't set the Punch card.

If an end needle (away from carriage) is set then push it back to Position B by hand. Slide the Lace carriage across the needles in one movement. (This will transfer every second stitch to the adjacent needle—automatically).

Reset the Tension Dial to normal setting for that wool and take up any slack in the yarn from the carriage to the knitting.

Bring all the empty needles into a straight line together with the others in position B. knit the other half of the hem (i.e.; 25 rows) and raise the first row of stitches as for the 'PLAIN HEM'.

Dropped Stitches

A. IF THE STITCH HAS DROPPED ONE ROW,

then with the single transfer tool pick up the stitch and the unknitted thread and put them both on the empty needle. Push the needle forward, until the stitch falls just behind the latch of the needle; catch the thread of the unknitted stitch into the hook of the needle, and push the needle back. The stitch will slide over the closed hook of the needle and be re-knitted.

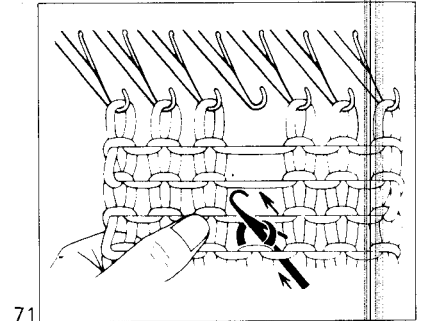

71

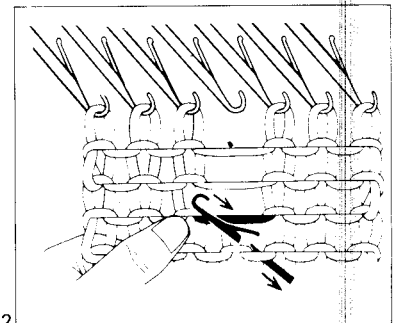

72

B. IF THE STITCH HAS DROPPED A NUMBER OF ROWS,

then insert the latch hook into the last stitch that has not dropped, from behind the fabric (i.e., the side that is not facing you).

(1) Hold the latch hook at right angles to the knitting, and pull the knitting down slightly.

(2) Push the tool towards you. The stitch will fall behind the latch. (See Fig. 71).

(3) Now pull the tool back, at the same time catching the thread across in the hook. Make sure to position the hook in the centre of the horizontal thread, and to pull, the tool all the way back until the stitch is formed. (See Fig. 72).

(4) In the same way knit the stitches all the way to the top stitch.

(5) Place the transfer tool (or a crochet hook) into the hook of the latch tool, and transfer the last stitch onto the transfer tool.

Now place the stitch onto the empty needle. (See Fig. 74).

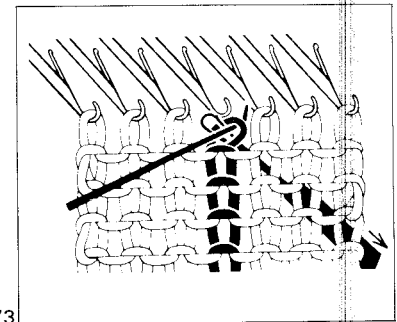

73

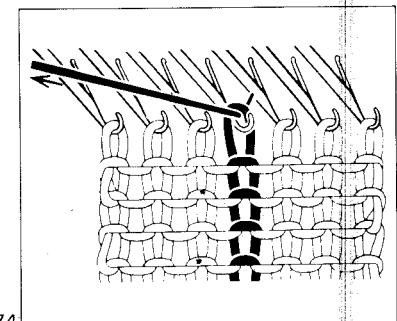

74

How to use the transfer tool

26

The transfer tools are used to move stitches onto different needles to effect the shaping of the garment, and also to form lacy patterns. Before transferring the stitches you should open the latches of the needles to be used.

(1) Hold the one eyed transfer tool parallel with the needles. Place the eye into the hook of the needle. (See Fig. 75).

(2) With the transfer tool, bring the needle forward. The stitch in the hook of the needle will slide behind the latch and onto the stem of the needle. (See Fig. 76).

(3) Without releasing the transfer tool, push the needle all the way back until the stitch is transferred onto the transfer tool (See Fig. 77).

(4) Raise the transfer tool with the stitch on it and transfer it to the adjacent needle, right or left as desired. (See Fig. 78).

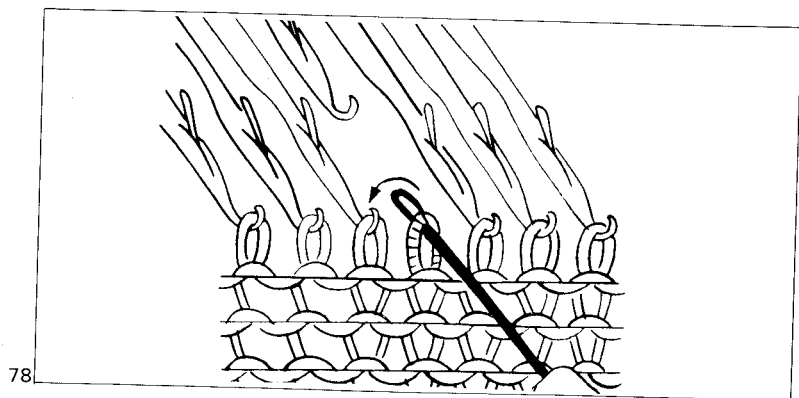
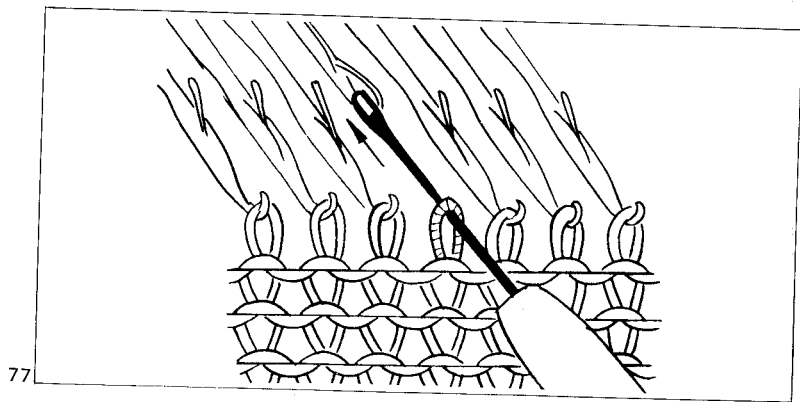
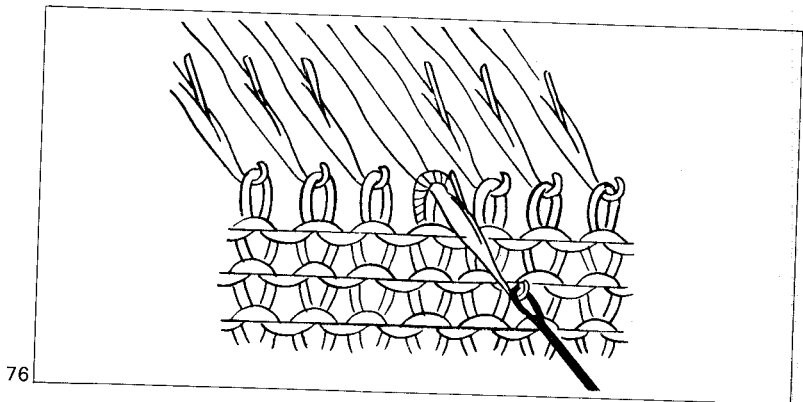
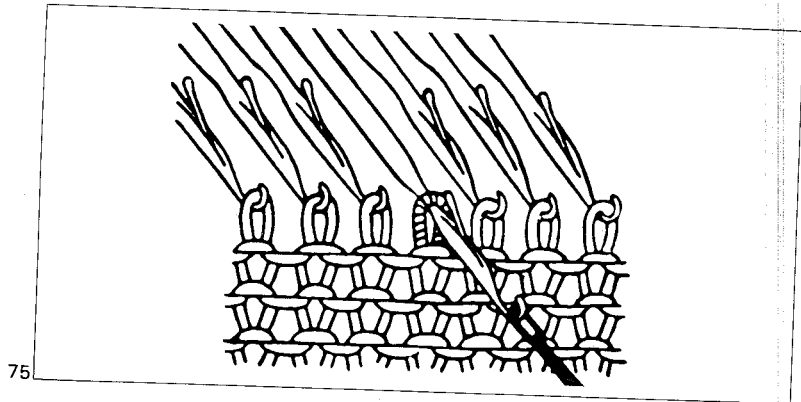

ONE STITCH AT EITHER EDGE

A. SIMPLE METHOD.

Simply bring into working position B one needle from position A, on the side nearest the carriage.

The empty needle will pick up the yarn on the next row.

B. FULLY FASHIONED METHOD. (1) Using the two needle transfer tool, move the stitches out by one needle so that the third needle from the end becomes empty.

(See Fig. 79).

(2) To fill in the empty needle pick up the purl side of either adjacent stitch on the lower row.

(See Fig. 80).

SEVERAL STITCHES AT EITHER EDGE

(1) Push the needles to be increased, to Position E on the same side as the carriage.

(2) Loosely wind the yarn around the stems of each needle, going around the needles from below.

(See Fig. 81).

(3) Set the H.C.L. to Position N.

(4) Knit across one row. To ensure perfect knitting on the increased stitches, raise these needles to Position E before knitting across for the next 2 or 3 rows.

INCREASING ONE STITCH IN THE CENTRE ROW

(1) Determine the position where you want to increase one stitch.

(2) Use the 3 needle transfer tool, starting from either end, transfer all the stitches outward in either direction until the required needle is free.

(See Fig. 82).

(3) Pick up the adjacent lower half stitch onto the empty needle.

(See Fig. 83).

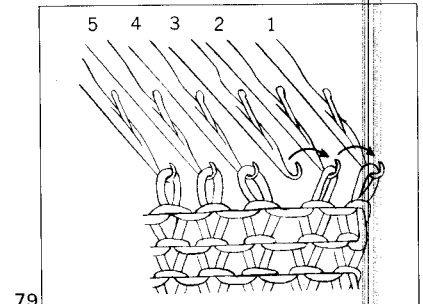

79

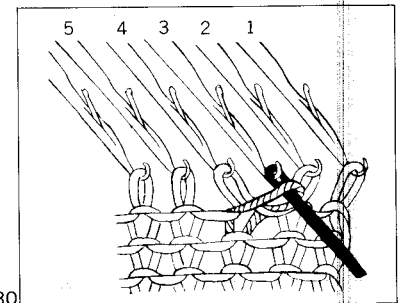

80

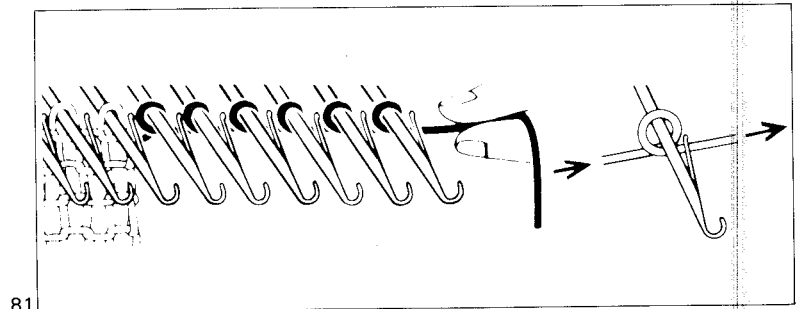

81

INCREASING SEVERAL STITCHES IN THE ROW

The afore mentioned method can be used working from the centre outwards, or you can transfer the knitting from the knitter to a knitting needle and then return the stitches. Before the knitting is transferred back from the knitting needles to the knitter, determine the number of stitches to be increased and space the replaced stitches so that there will be an equal number of stitches transferred between each extra needle (leaving empty needles where extra stitches are required). Raise the neighbouring lower half stitches to the empty needles. (See Fig. 83).

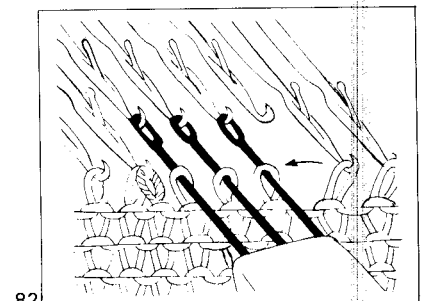

82

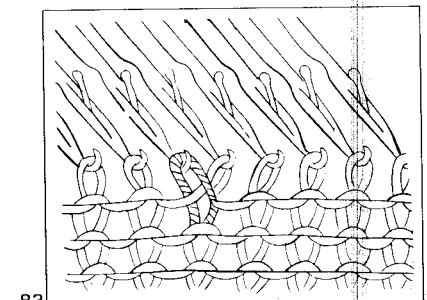

83

Transferring to hand knitting needles

28

(1) Slide a hand knitting needle into the first stitch from behind the knitting. With your left hand hold the knitting close to the knitter. With your finger, bring the needle forward so that the stitch in the hook of the needle slide onto the stem of the needle, behind the latch.

(2) Push the needle all the way back so that the stitch slips all over the closed hook of the needle onto the knitting needle.

(3) Slide the knitting needle into the next stitch and repeat until all the stitches are off the needles on the needle bed.

TRANSFERRING OFF THE HAND KNITTING NEEDLE ONTO THE KNITTER

A. USING THE TRANSFER TOOL.

(1) Open the needle latches.

(2) Hold the fabric in your left hand with the desired side facing you, the hand knitting needle being in line with the needles.

(3) Pass the transfer tool through the stitch on the knitting needle from the front. (See Fig. 85).

(4) Transfer the stitch from the transfer tool onto the hook of machine needles. Push the needle with the transferred stitches back as far as they will go.

B. ALTERNATE METHOD

(1) Bring the needles forward to Position 'D', and open the latches.

(2) Begin from the left side.

(3) Transfer the stitches from the hand knitting needle onto the open hooks of the machine needles. (See Fig. 86).

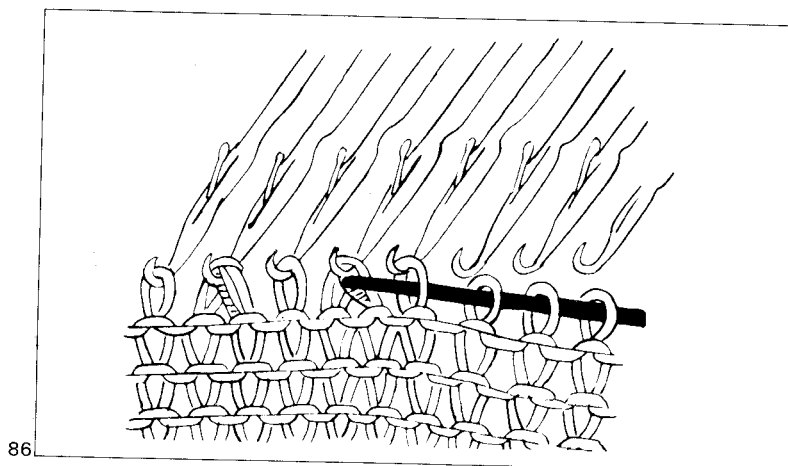
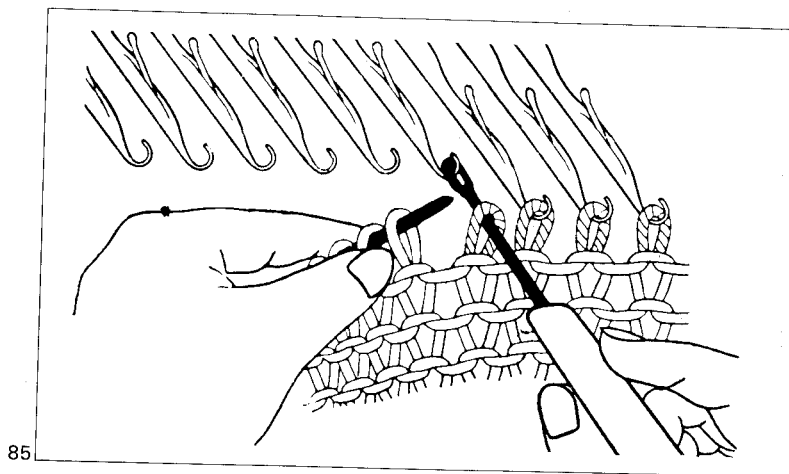
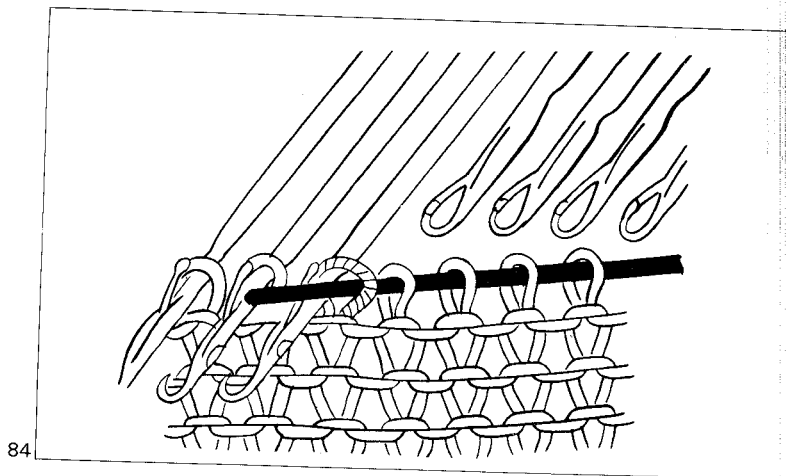

Decreasing stitches

ONE STITCH AT EITHER EDGE

A. SIMPLE METHOD.

Using the single transfer tool, transfer the end stitch onto the second needle (See Fig. 87) and push empty needle back to Position 'A'.

B. FULLY FASHIONED DECREASING.

With the single transfer tool, transfer 2nd stitch onto 1st stitch, then bring both back onto 2nd needle and knit. For decreasing at NECK, ARMHOLES AND SLEEVES, it is advisable to use the 2 prong transfer tool and move 2 stitches in (towards knitting) 1 stitch. (K1, K2 tog.).

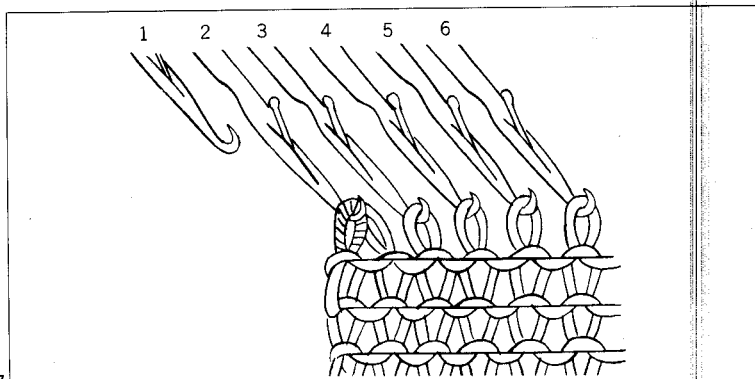

DECREASING ONE STITCH IN THE CENTRE OF ROW

- (1) Use the single transfer tool and transfer a center stitch to adjacent needle. (See Fig. 88).
- (2) Using the 3 needle transfer tool, shift all stitches in until all needles 'in action' have stitches on them, and place the outer empty needles out of action. (See Fig. 89).

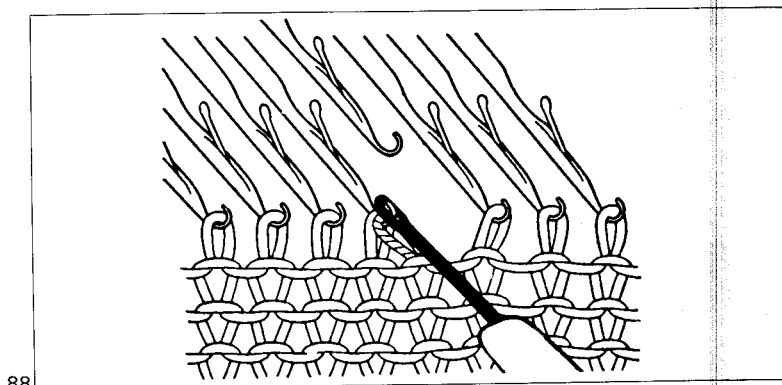

DECREASING SEVERAL STITCHES IN A ROW

- (1) Transfer the knitting to a hand knitting needle: (See Fig. 84).
- (2) Before returning the knitting from the knitting needle back to the knitter, calculate the proportional reduction in the number of stitches. For example, to decrease one stitch in every three, hang the 2nd and 3rd stitches both onto one needle. (See Fig. 90).
- (3) The number of needles with double stitches represents the number of stitches

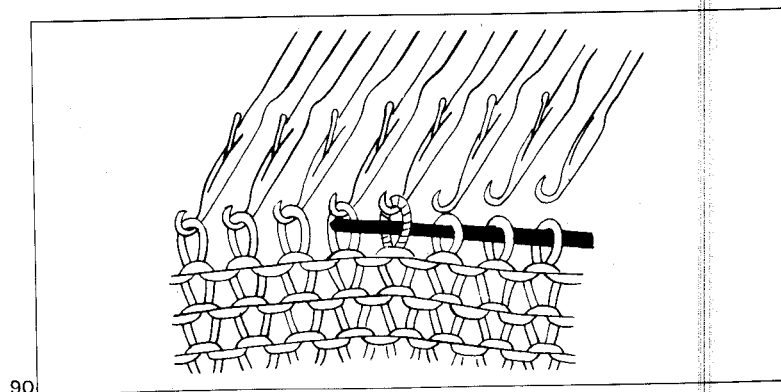
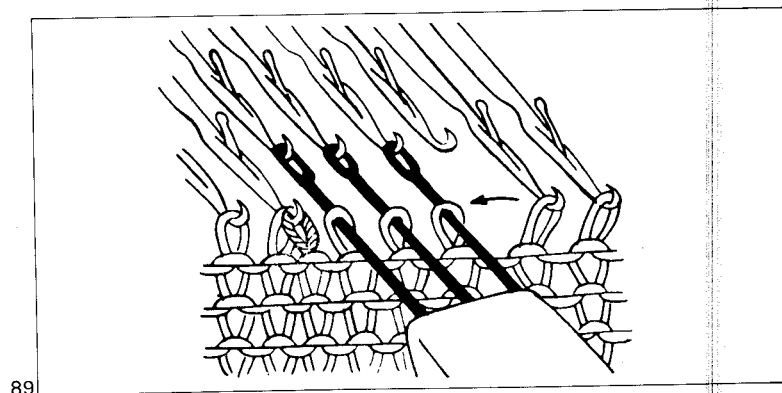

METHOD A

- (1) On the same side as the carriage, transfer the end stitch to the 2nd needle. (See Fig. 91).
- (2) Bring forward the needle with the two stitches so that the stitches fall behind the needle latch. (See Fig. 92).
- (3) Place the yarn in the needle hook, in front of the latch and push the needle back manually to form a single stitch. (See Fig. 93).
- (4) Repeat this process for each stitch. Take care not to make the stitches too tight.

After practicing this, you may find it easier to transfer the stitch you have formed by hand, without using the transfer tool.

METHOD B

- This method can be used for binding off any number of stitches at neck, armhole, shoulder or pocket edges.
- (1) Knit the last row on a much looser tension than the rest of the garment.
 - (2) Start on the side opposite the carriage.
 - (3) Hold the latch tool upright, so latch remains open.
 - (4) Insert the latch hook into the first 2 stitches and remove them from the needles. Let the first stitch slide past the latch.
 - (5) Pull the second stitch through the first—this leaves one loop in the hook of your latch tool. Continue to bind off one stitch at a time, and seal the last stitch with a slip knot. (See Figs. 95 and 96).
- No mention is made in these instructions of decreasing at the center of the neck or of shaping at the armholes. Whilst following the steps below, the decreasing and shaping must

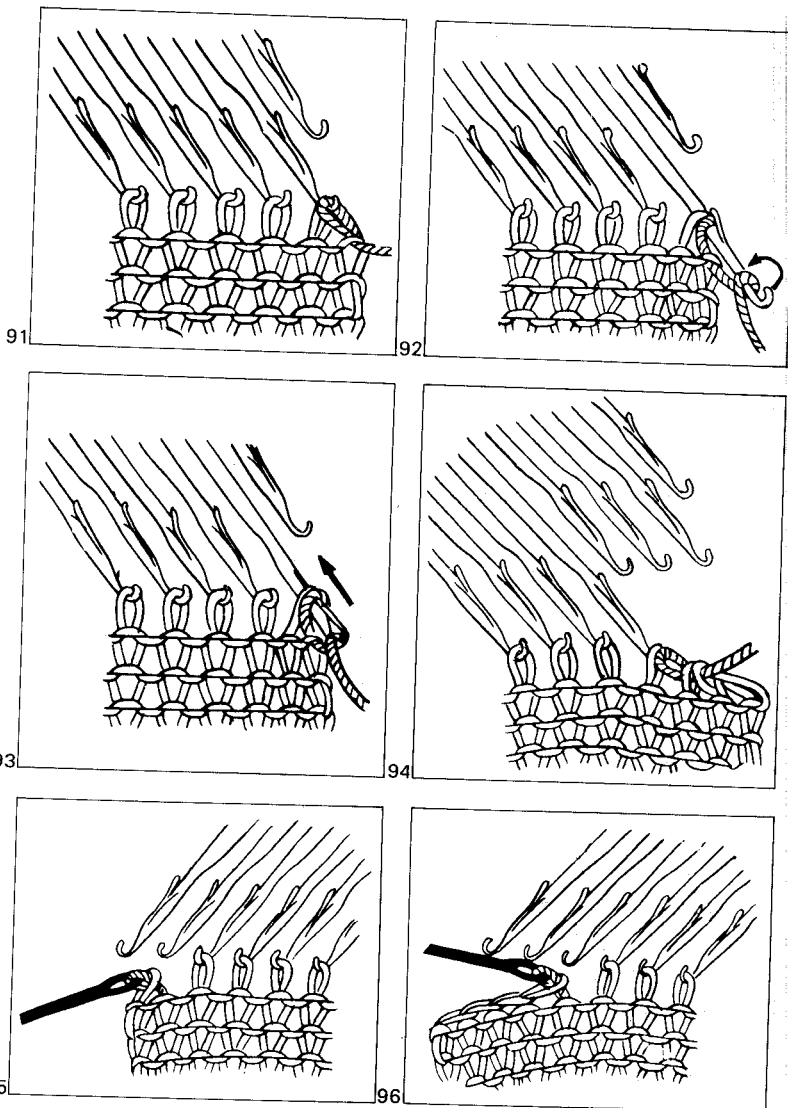

be carried out according to the instructions in the knitting pattern, or according to the measurements of the garment. Remember to put all empty needles back to Position 'A' after transferring and before continuing to knit.

TO REMOVE THE KNITTING FROM THE KNITTER

Unbound (unfinished) method.

- (1) Take the yarn out of the yarn feeder on the carriage, and rethread with any contrast colour yarn (waste yarn).
- (2) Knit 5 rows using the waste yarn, then remove the yarn from the yarn feeder.
- (3) Press the work against the needle bed and slide the carriage twice across the needles in action. The work will be released.

Pattern knitting

There are 25 Punch cards provided. From these 25 basic cards, it is possible to knit 68 different fancy stitch patterns. The following pictures are knitted by using these cards, and instructions of each pattern are explained on page 41 to 53.

It is recommended to use the Punch card marked ○ for each pattern knitting.

Pattern	Recommended Punch Card No.																									
	1	2	3	4	5	6	7	8	9	10	11	12	13	14	15	16	17	18	19A	20A	21A	22A	23A	24A	25A	
Tuck stitch pattern	○	○		○	○		○	○	○	○	○	○	○	○												
Two colours "		○	○		○					○					○											
Skip stitch pattern				○			○	○		○				○	○	○										
Two colours "						○		○	○					○												
Fair- isle pattern	○	○	○	○	○	○	○	○	○	○	○	○	○	○	○	○	○	○	○	○	○					
Weaving pattern	○	○	○	○	○	○	○	○		○	○	○	○	○		○										
Lace pattern																						○	○	○	○	○

*The Punch cards No. 21A to 25A are special lace knitting cards.

NOTE: The tension number which is indicated under the picture is the tension on the Carriage dial that this pattern was knitted in. The tension differs for each type of yarn, and therefore this number can only be used as a guide.

Tuck stitch patterns

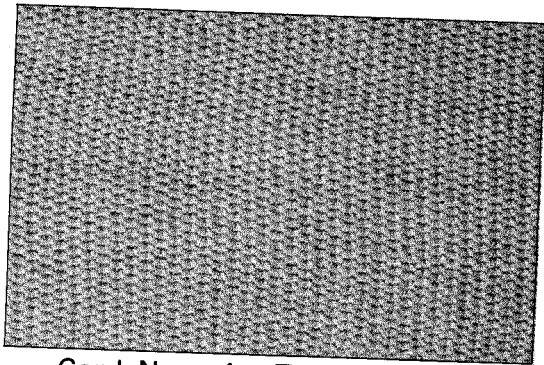

Card No. 1, Tension No. 5

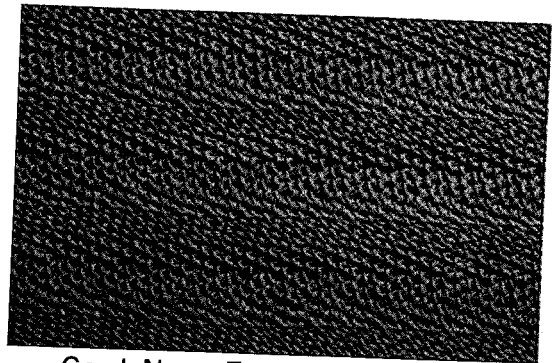

Card No. 7, Tension No. 4

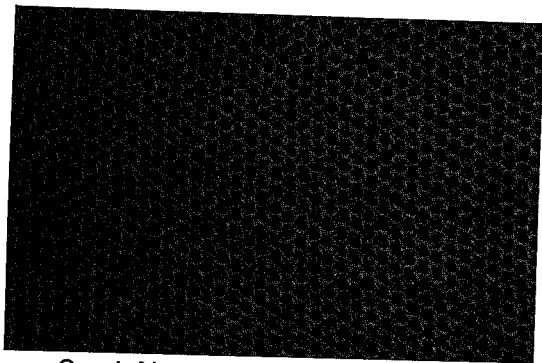

Card No. 2, Tension No. 5

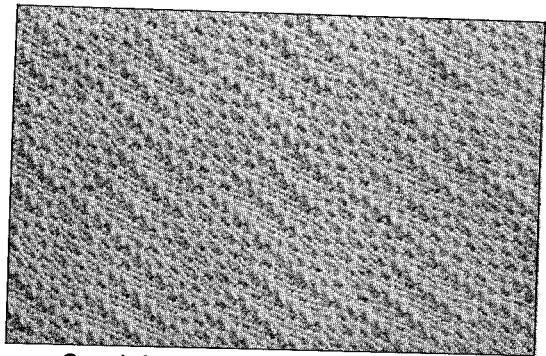

Card No. 8, Tension No. 5

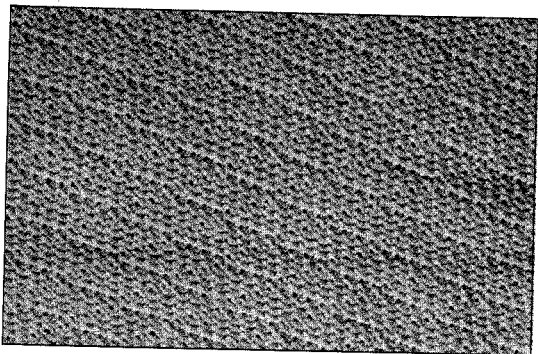

Card No. 4, Tension No. 5

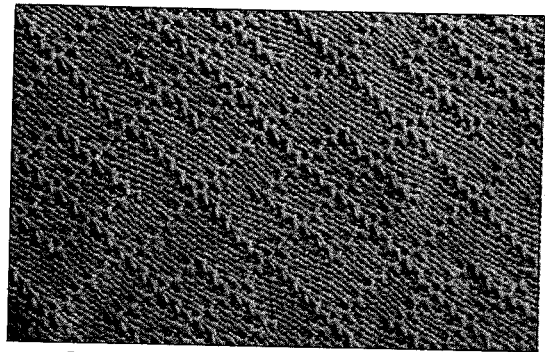

Card No. 9, Tension No. 5

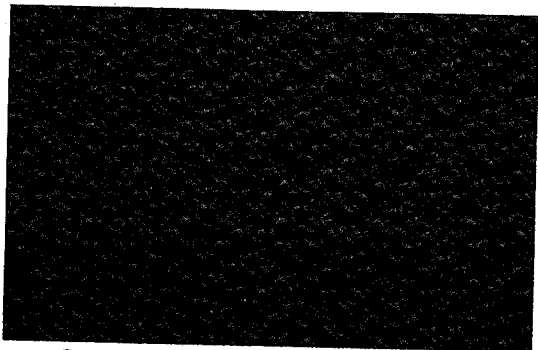

Card No. 5, Tension No. 5

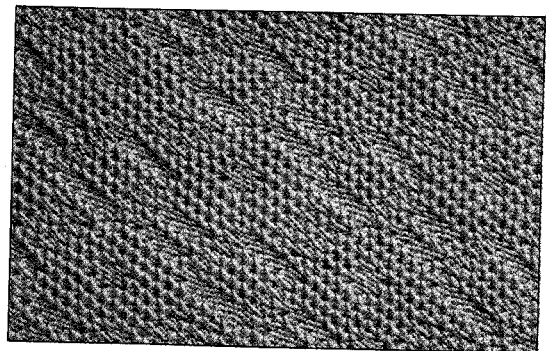

Card No. 10, Tension No. 5

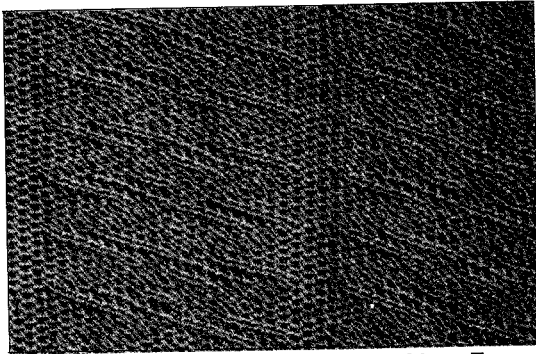

Card No. 11, Tension No. 5

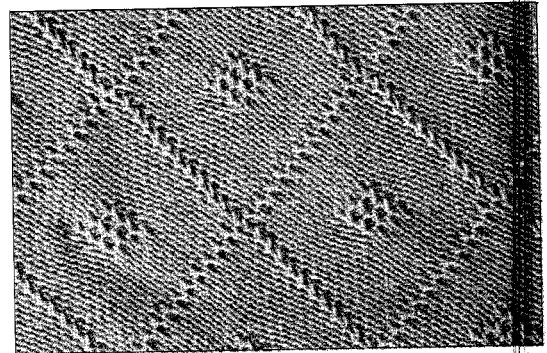

Card No. 15, Tension No. 5

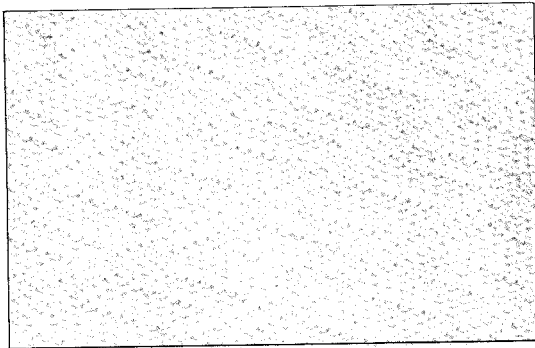

Card No. 12, Tension No. 5

Two colours Tuck stitch patterns

*Change the yarn in the Yarn feeder "A" every third row.

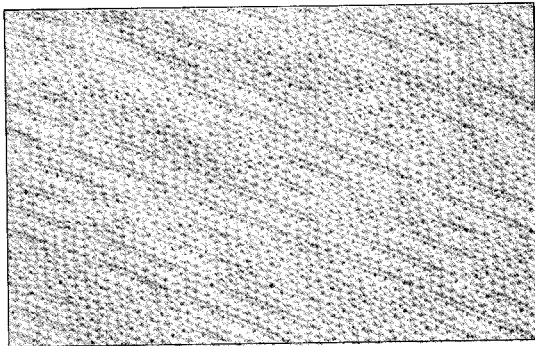

Card No. 13, Tension No. 5

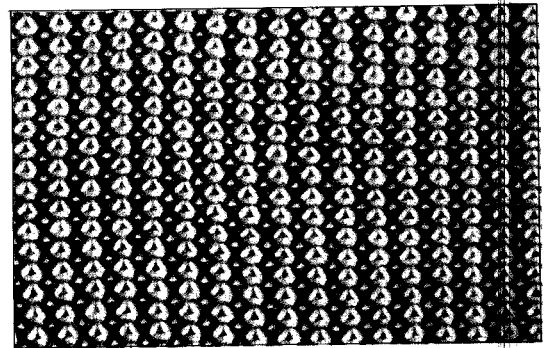

Card No. 2, Tension No. 5

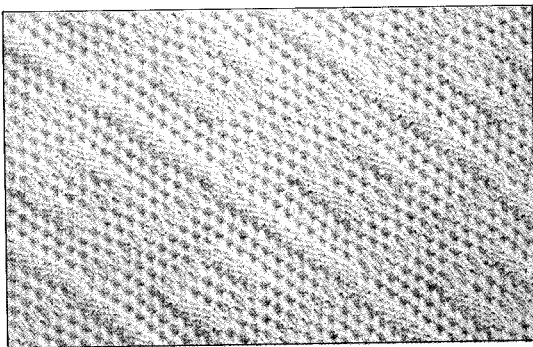

Card No. 14, Tension No. 5

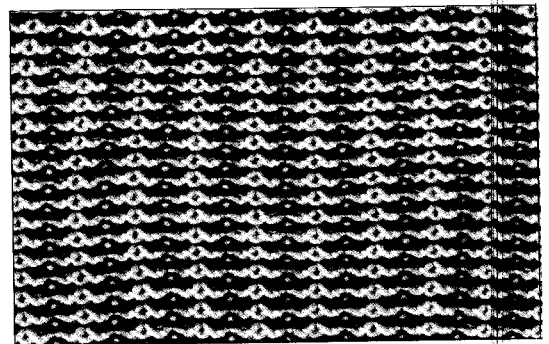

Card No. 3, Tension No. 5

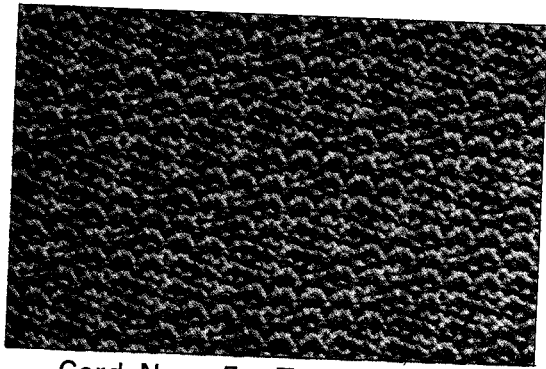

Card No. 5, Tension No. 5

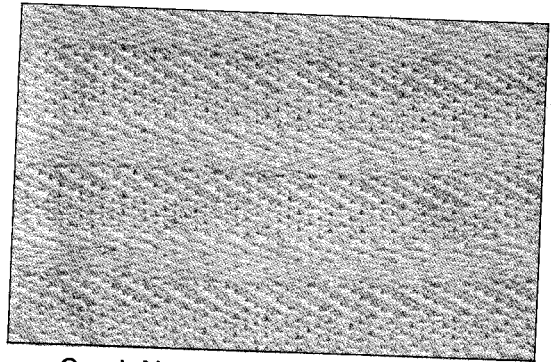

Card No. 7, Tension No. 6

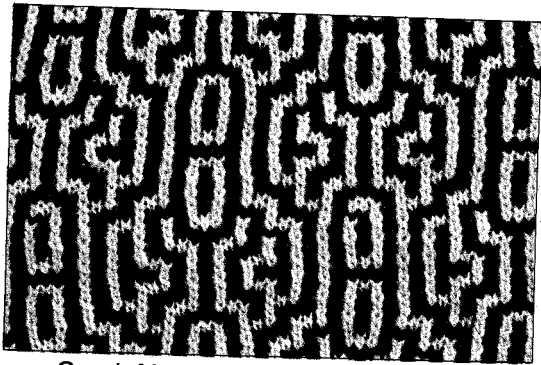

Card No. 10, Tension No. 5

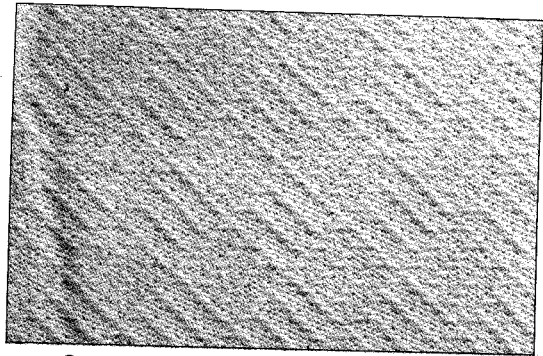

Card No. 8, Tension No. 6

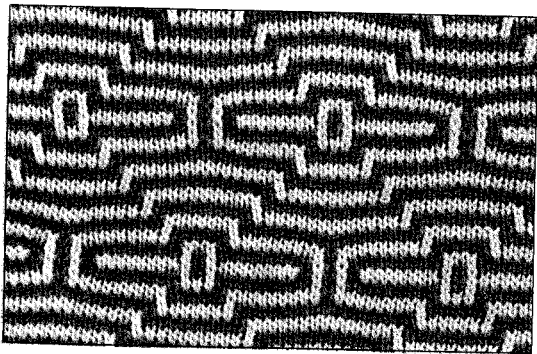

Card No. 15, Tension No. 5

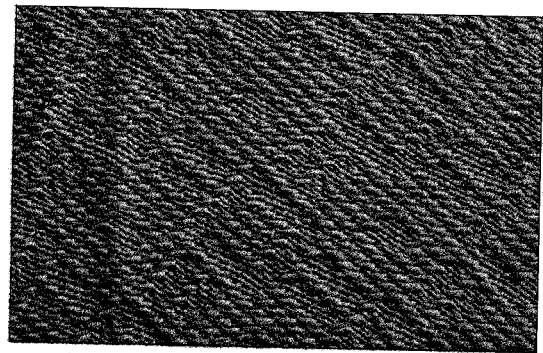

Card No. 10, Tension No. 6

Skip stitch patterns

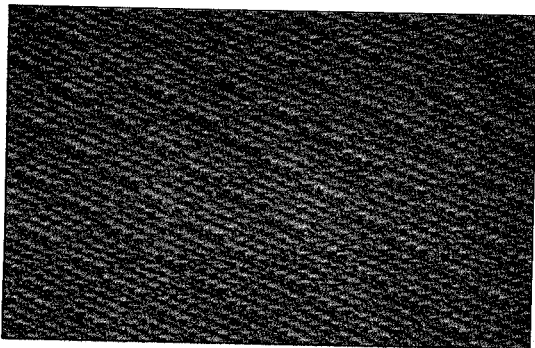

Card No. 4, Tension No. 6

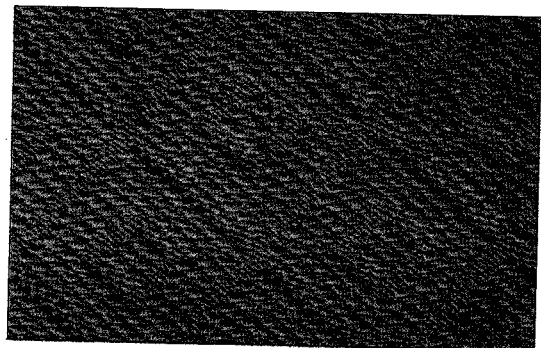

Card No. 14, Tension No. 6

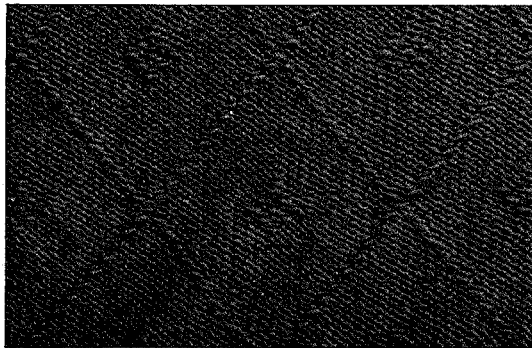

Card No. 15, Tension No. 6

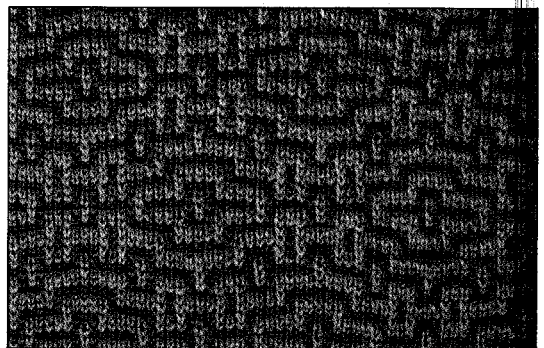

Card No. 9, Tension No. 9

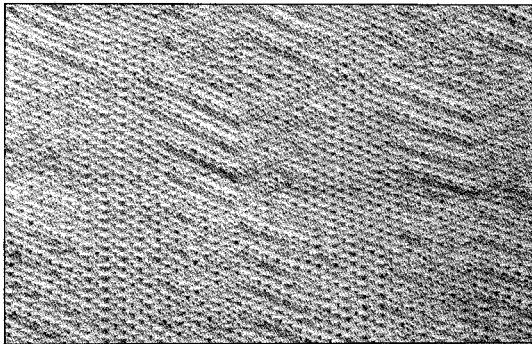

Card No. 16, Tension No. 6

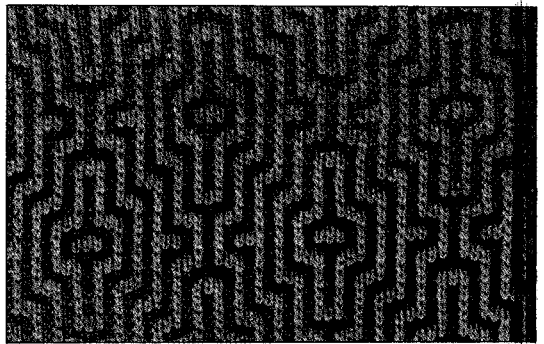

Card No. 14, Tension No. 6

Two colours Skip stitch patterns

*Change the yarn every third row.

Fair-isle patterns

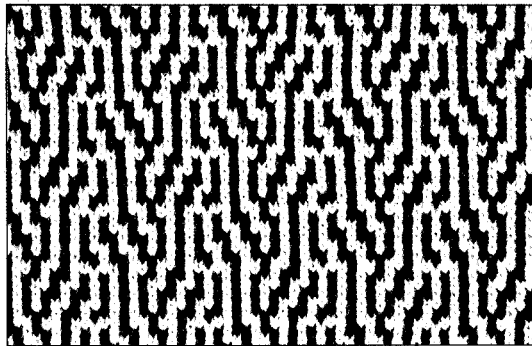

Card No. 6, Tension No. 6

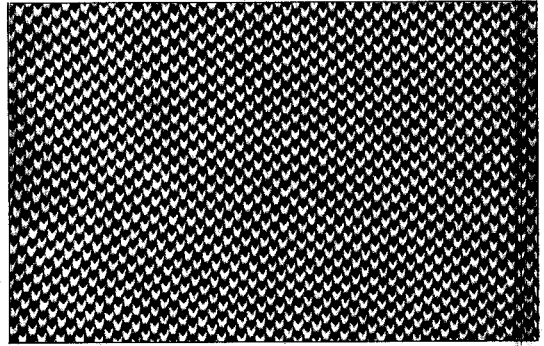

Card No. 1, Tension No. 6

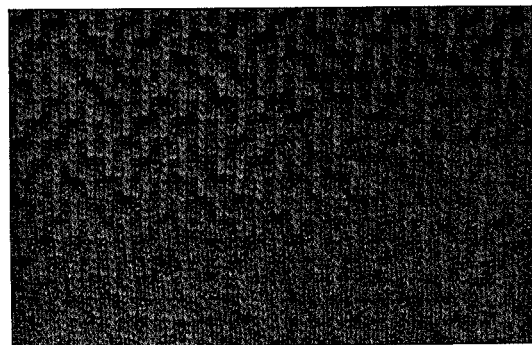

Card No. 8, Tension No. 6

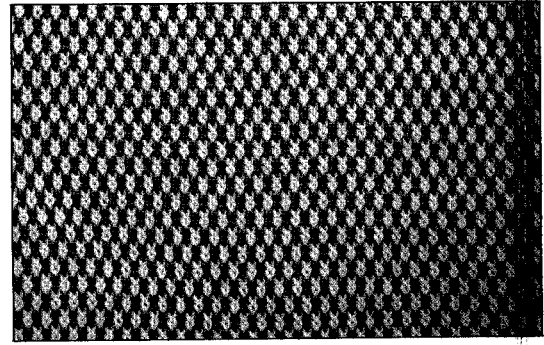

Card No. 2, Tension No. 6

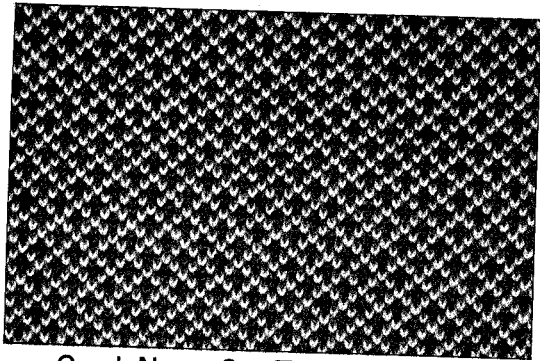

Card No. 3, Tension No. 6

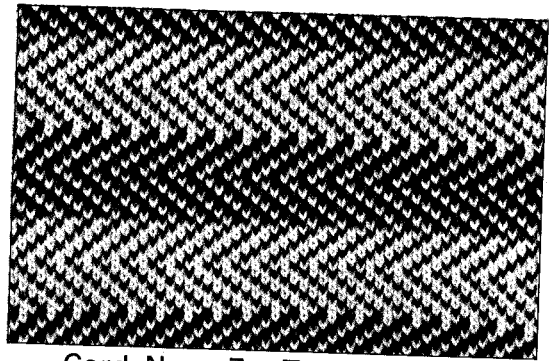

Card No. 7, Tension No. 6

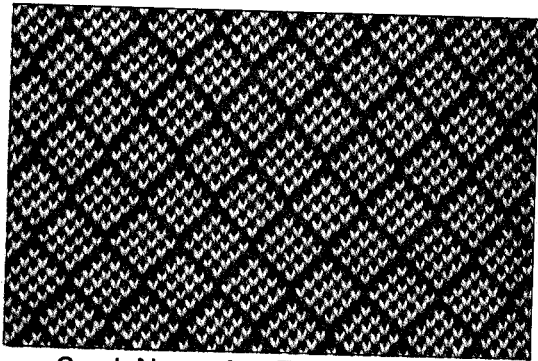

Card No. 4, Tension No. 6

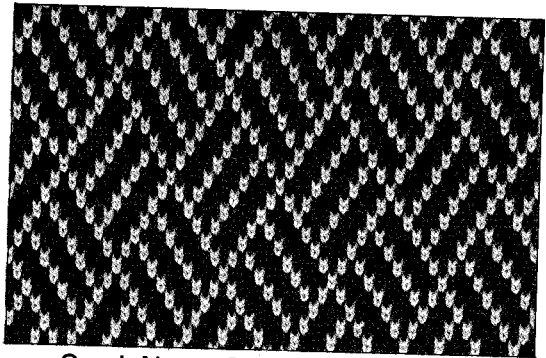

Card No. 8, Tension No. 6

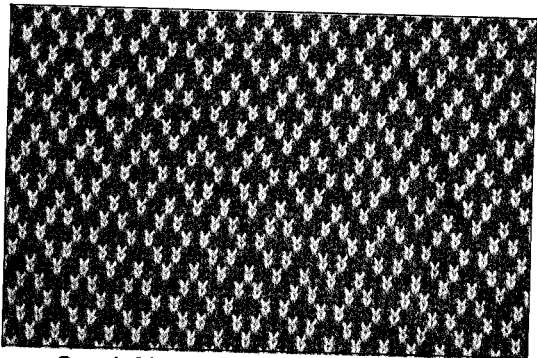

Card No. 5, Tension No. 6

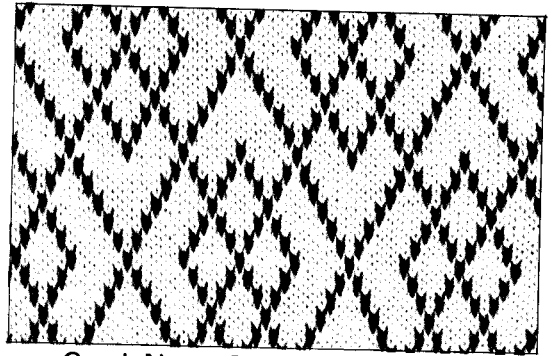

Card No. 9, Tension No. 6

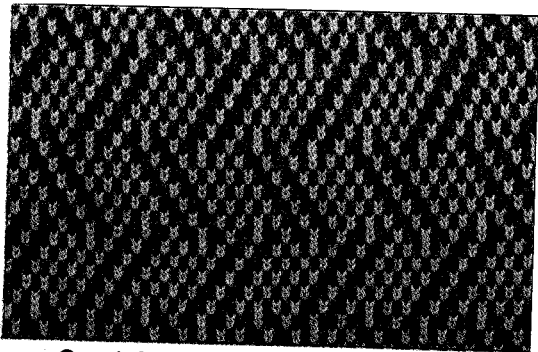

Card No. 6, Tension No. 6

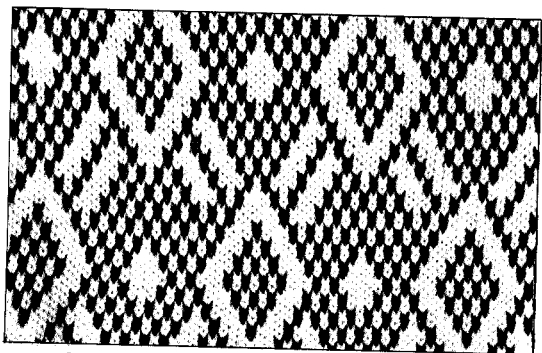

Card No. 10, Tension No. 6

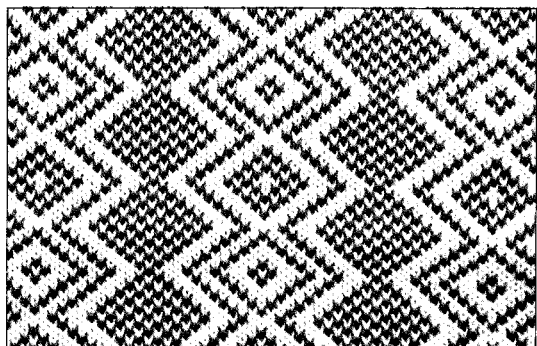

Card No. 11, Tension No. 6



Card No. 15, Tension No. 6

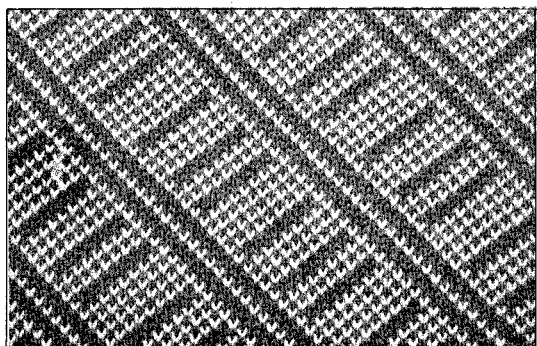

Card No. 12, Tension No. 6

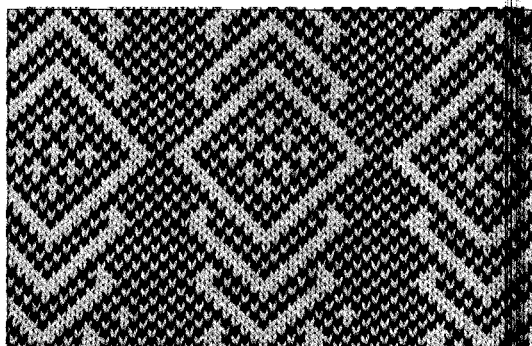

Card No. 16, Tension No. 6

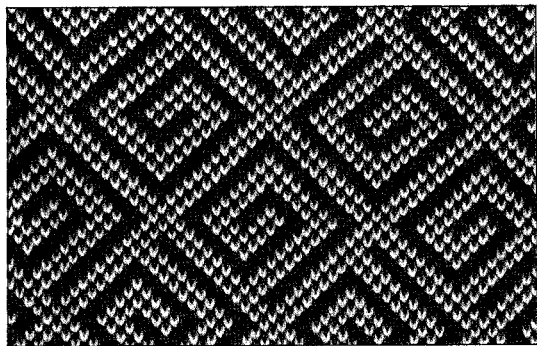

Card No. 13, Tension No. 6

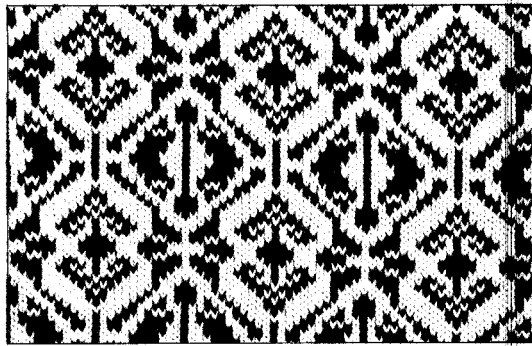

Card No. 17, Tension No. 6

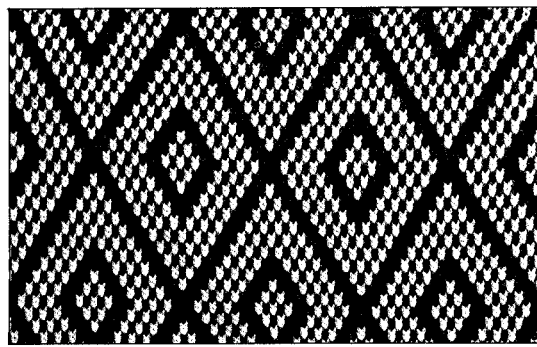

Card No. 14, Tension No. 6



Card No. 18, Tension No. 6

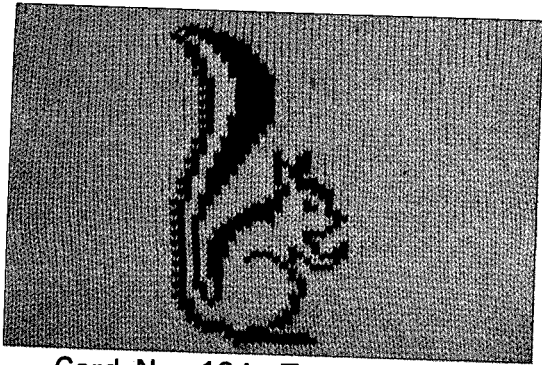

Card No. 19A, Tension No. 6

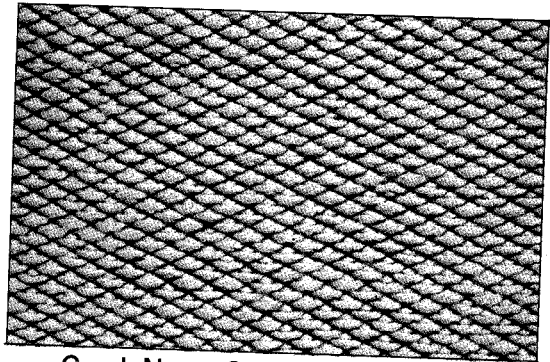

Card No. 3, Tension No. 6

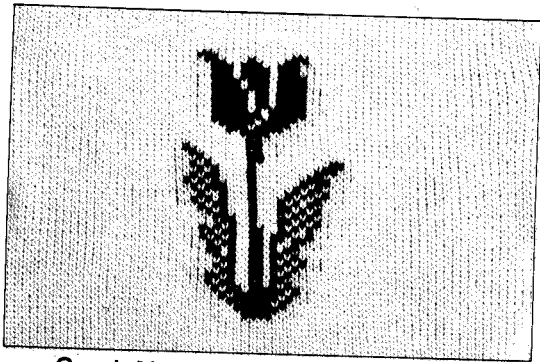

Card No. 20A, Tension No. 6

Weaving patterns

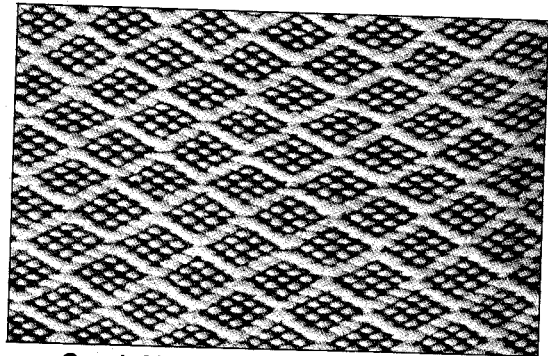

Card No. 4, Tension No. 6

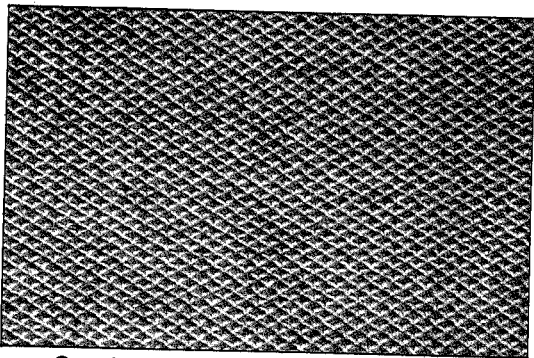

Card No. 1, Tension No. 6

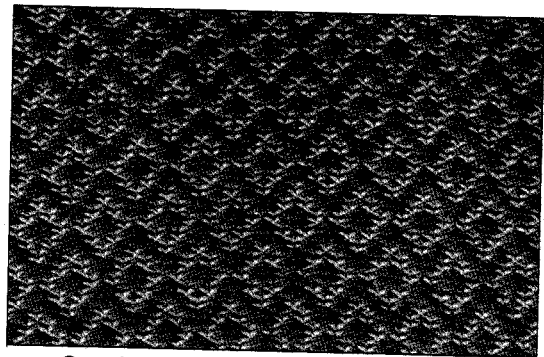

Card No. 5, Tension No. 6

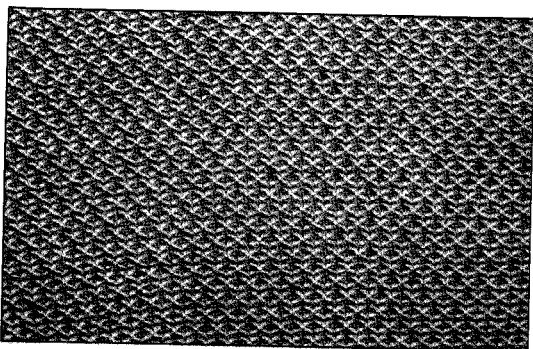

Card No. 2, Tension No. 6

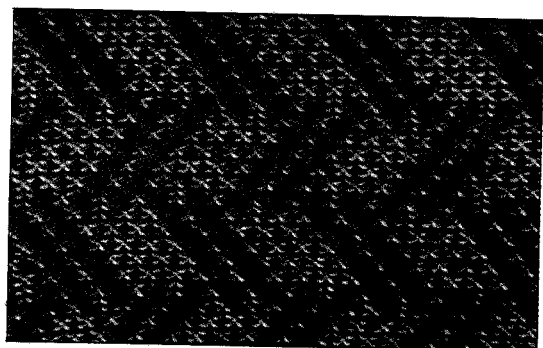

Card No. 6, Tension No. 7

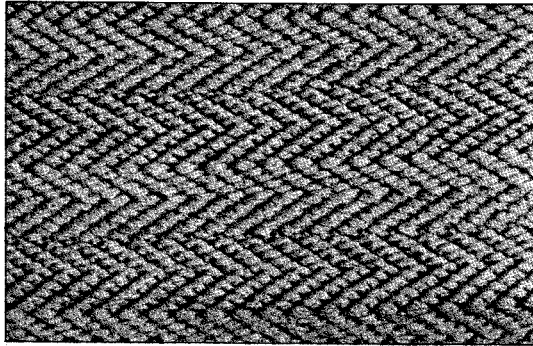

Card No. 7, Tension No. 7

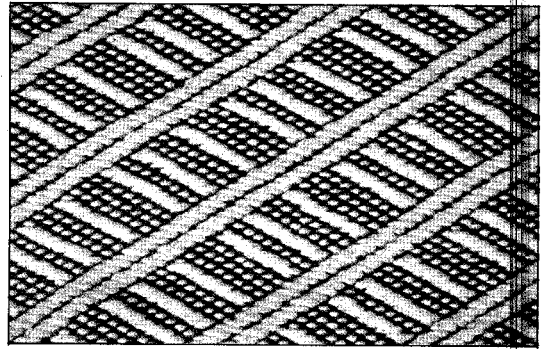

Card No. 12, Tension No. 6

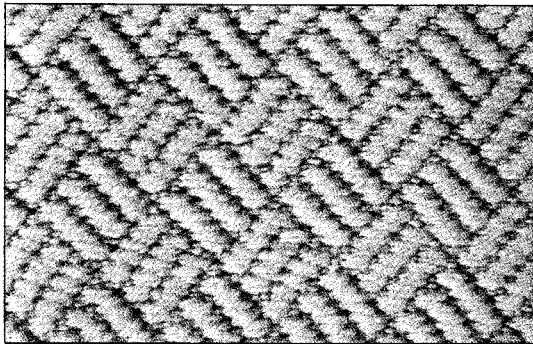

Card No. 8, Tension No. 7

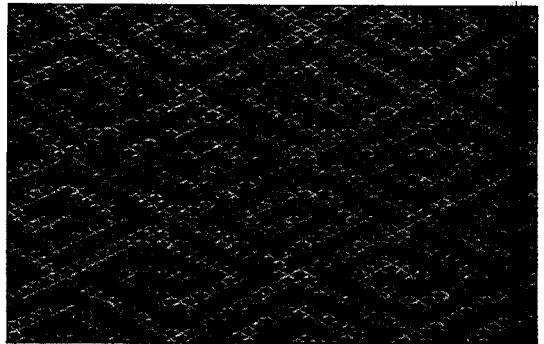

Card No. 13, Tension No. 6

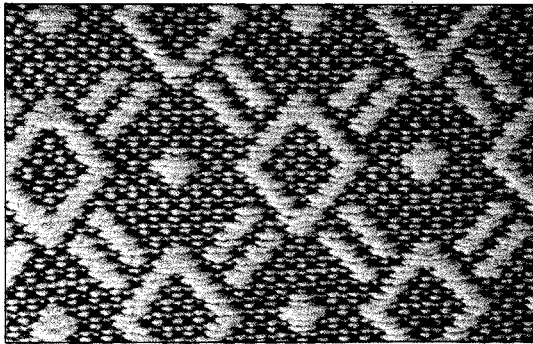

Card No. 10, Tension No. 7

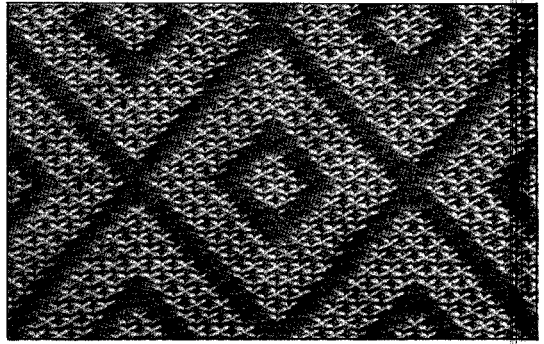

Card No. 14, Tension No. 6



Card No. 11, Tension No. 7

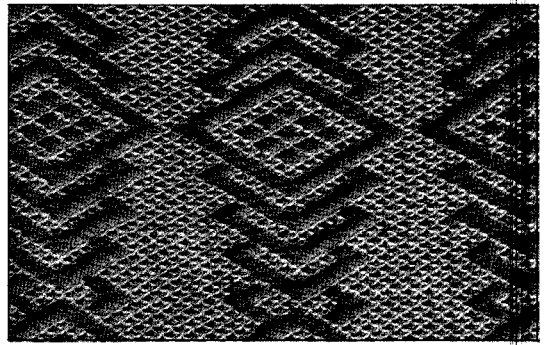

Card No. 16, Tension No. 6

Lace patterns

※ Carefully check the direction of
L carriage and K carriage.

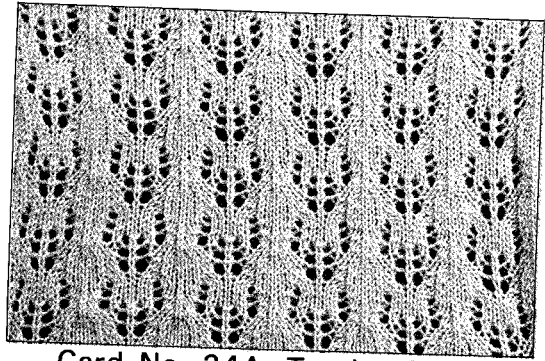

Card No. 24A, Tension No. 5

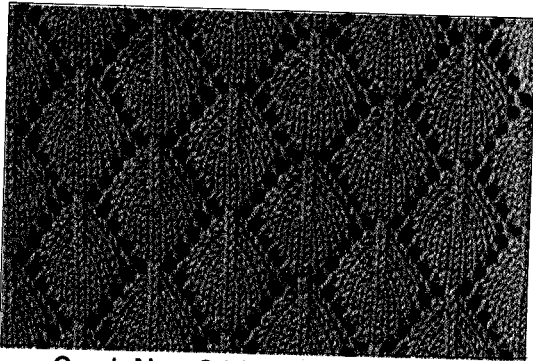

Card No. 21A, Tension No. 5

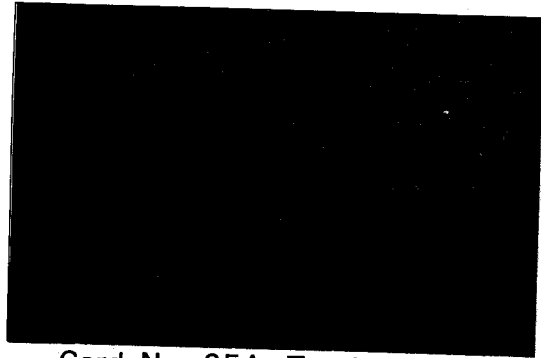

Card No. 25A, Tension No. 5

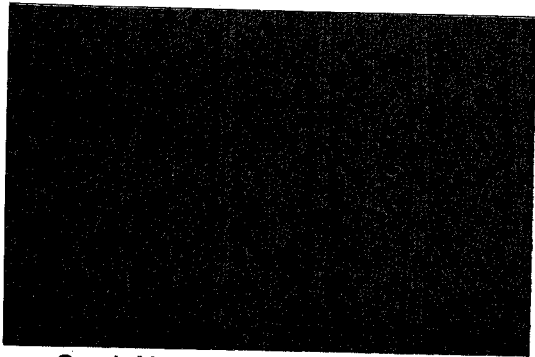

Card No. 22A, Tension No. 5

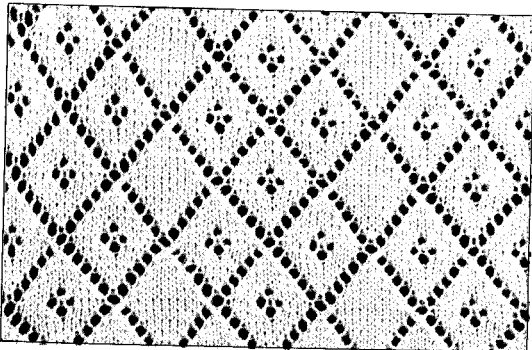

Card No. 23A, Tension No. 5

How to use the Punch cards

WHICH NEEDLE IS SELECTED BY THE PUNCH CARD?

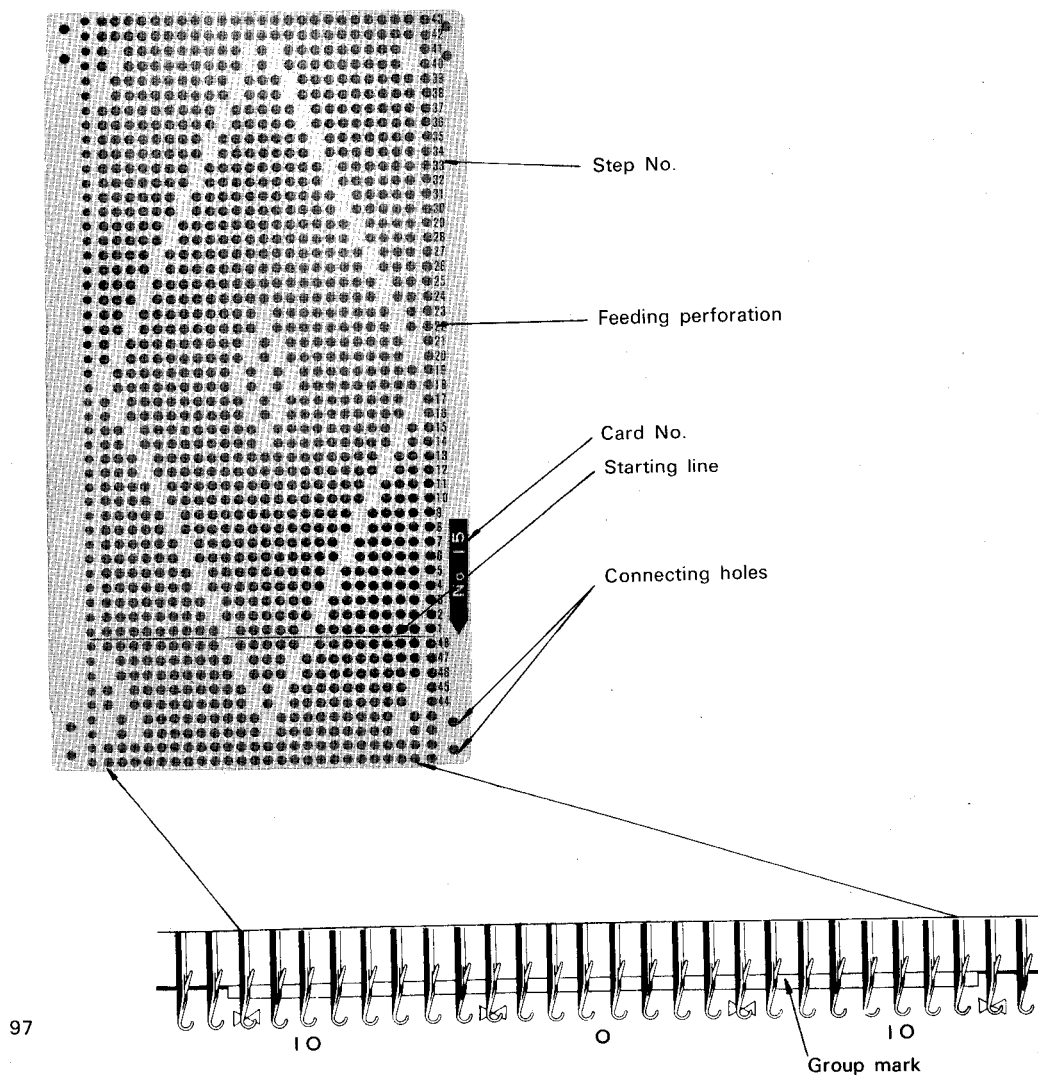

* Each perforated line of the Punch card controls a needle group, namely 24 needles, and the combination of perforations made on the Punch card will control the corresponding combination of selected needles for that step. The needles corresponding to the perforations made on the Punch card can be selected by moving the Carriage across the needles in working position.

SETTING THE PUNCH CARD

1. Insert the Punch card holder pin in the hole at the back of the knitter.

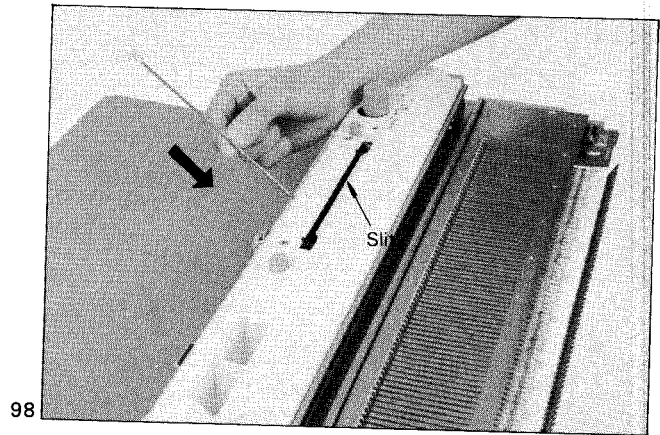

2. Insert the Punch card into the slit with the number facing you. Please be careful when inserting the Punch card, it should be straight.

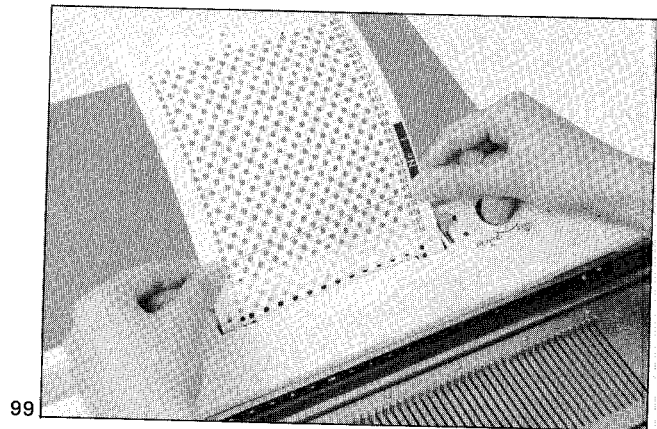

3. Make sure the Starting line is parallel to the Panel. Press down the Feeding knob and turn to left (to FEED) to feed the Punch card.

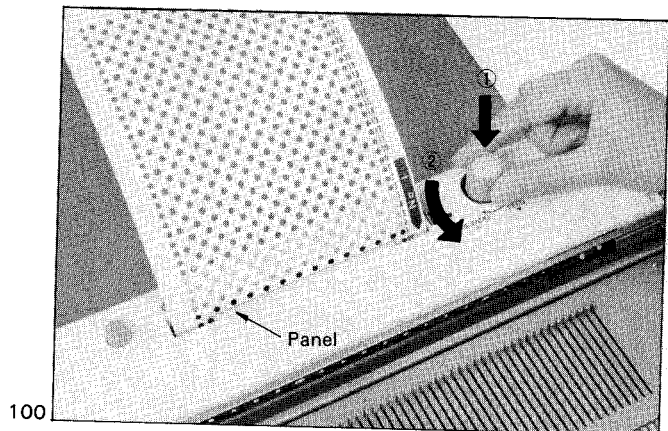

4. It is easier to turn the Feeding knob by pressing down the Push button at the same time.

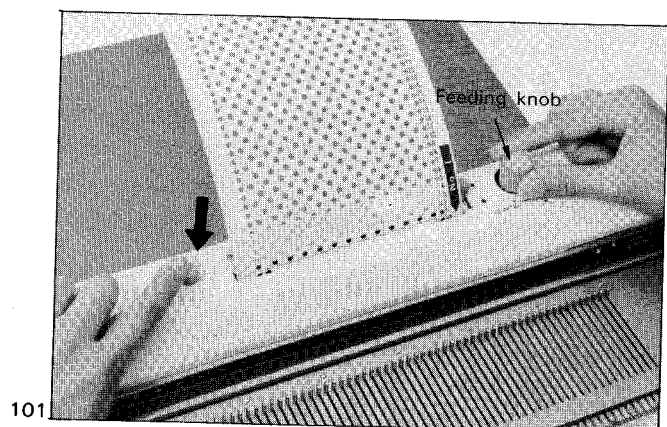

5. When the Punch card has been inserted, the two ends must be overlapped and clipped together with the special plastic Snaps provided. This enables the card to rotate continuously.

It is important to overlap the card ends correctly as illustrated. When clipped together the numbers on the card must continue in the right sequence without any break.

6. Turn the Feeding dial and set to the starting position.

Set the Card lock lever to the "●" mark, in which the card is locked. (Even if the Carriage is moved across the Needle bed, the Punch card will not rotate.)

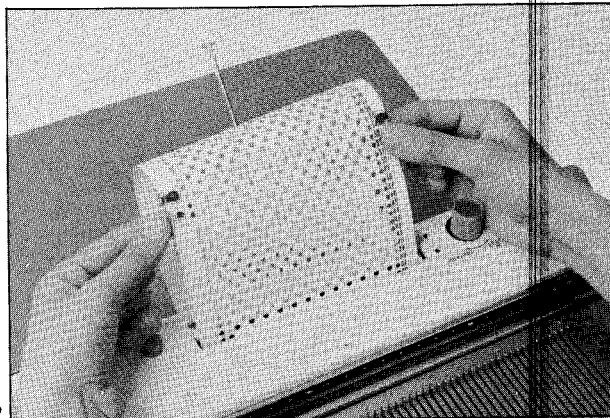

102

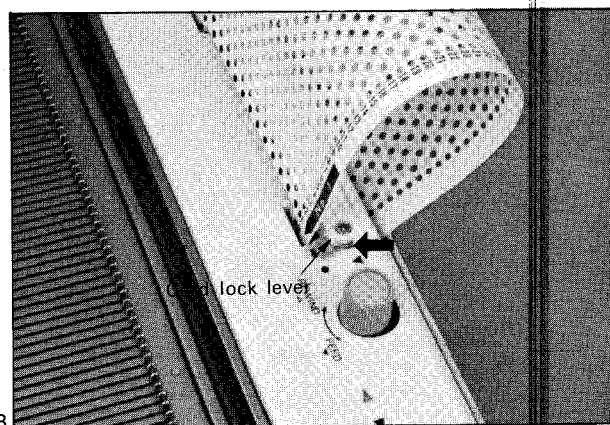

103

PREPARATION OF PATTERN KNITTING

1. Knit several rows with PLAIN and place the Carriage on the left side of the needle bed.
2. Set the desired Punch card to the starting position.
3. Set the Card lock lever to the "●" mark.
4. Set the Change knob to position KC for K carriage card selection.

SPECIAL NOTE

For Lace knitting, set the Change knob to position N.L.

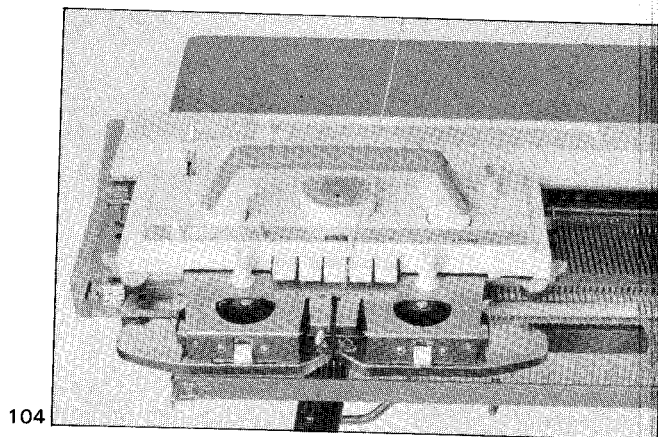

104

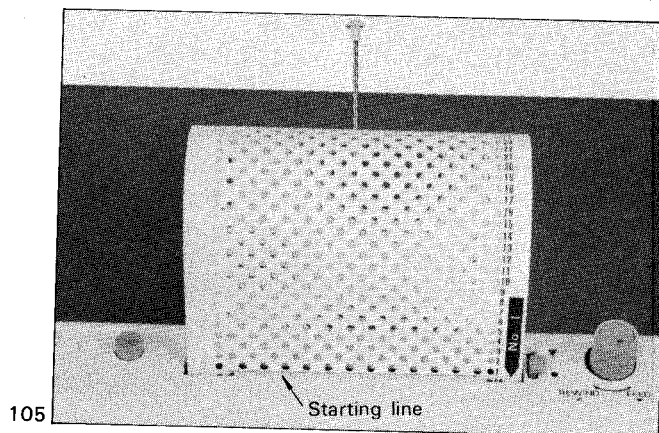

105

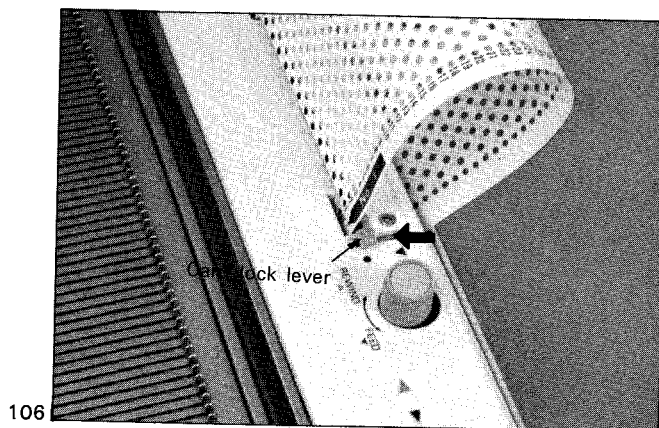

106

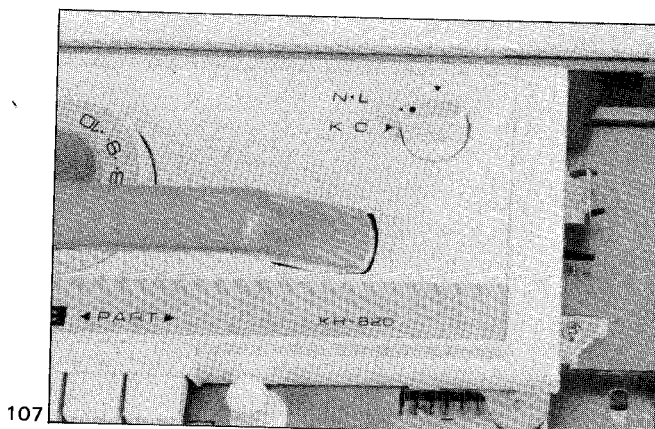

107

5. Set the Weaving pattern lever to position N.

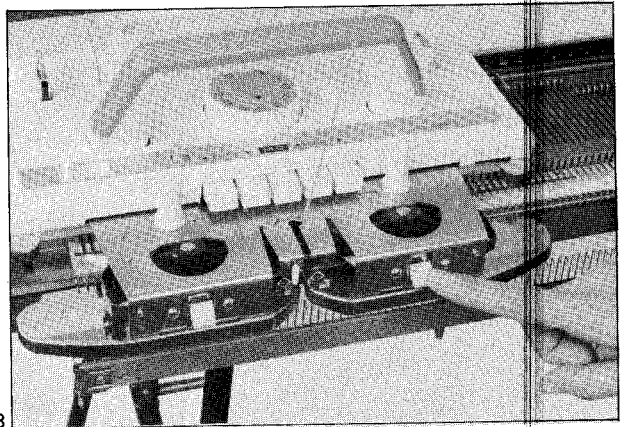

108

6. Choose the suitable tension number for the yarn you are going to knit. Number 5 or 6 is usual for medium thickness yarn.

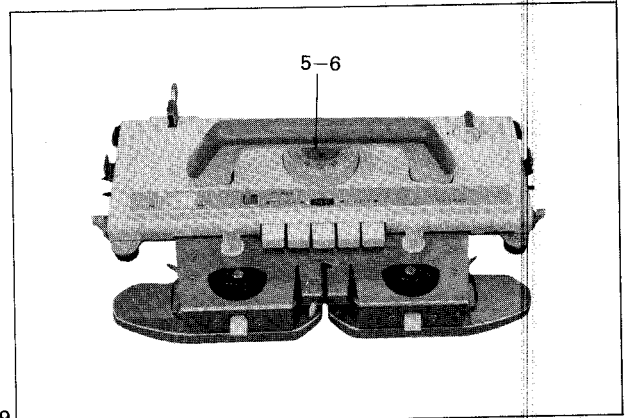

109

7. By moving the Carriage across the needles to right, the needles are selected automatically. After moving the Carriage, you will notice the arrow mark on the right end of the machine. This mark indicates the direction in which the K carriage has been moved and that the Punch card has been fed one step.

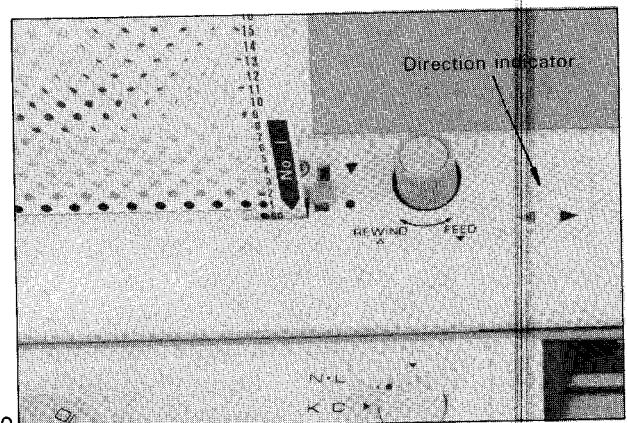

110

8. Set the Card lock lever to the "▼" mark.

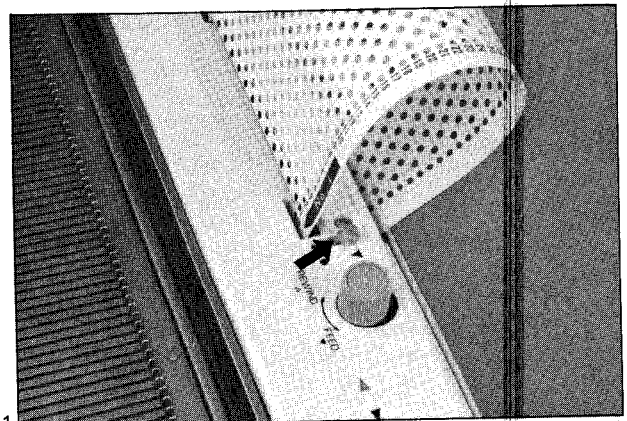

111

Tuck stitch patterns

*See the chart on page 31 which indicates which Punch cards are suitable for Tuck stitch patterns.

1. After setting the Punch card, push both TUCK buttons and proceed to knit as in plain knitting for 4 rows.
2. Hang the Claw weights on to each end of the knitting as illustrated and continue knitting. It is essential that the Claw weights are used in Tuck stitch patterning to prevent drop stitches occurring on the end needles. The Claw weights should be repositioned at the top of the knitting at regular intervals.
3. Should a drop stitch occur at the edge, simply bring forward the end needle into the D position by hand. If an end needle is not brought to D position by the Punch card and Carriage movement.

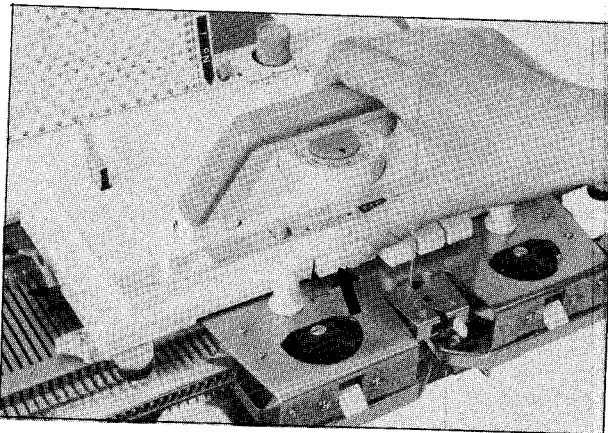

112

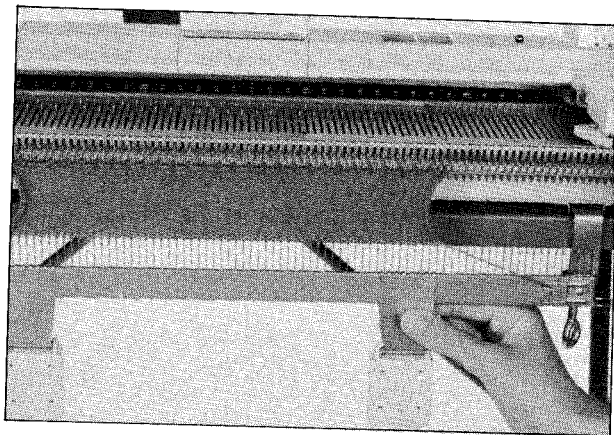

113

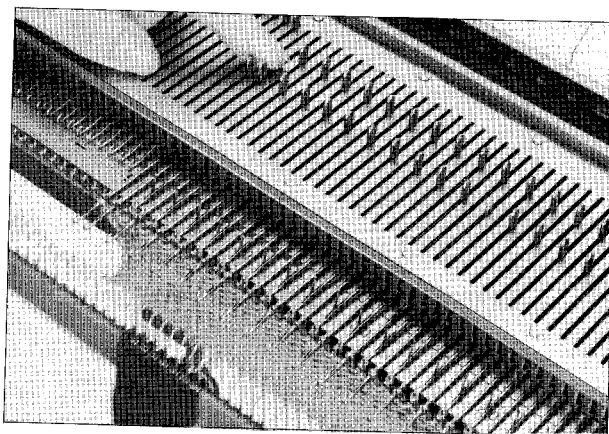

114

Two colours Tuck stitch patterns

*Using two different colour yarns, knit the Tuck stitch patterns.

1. After setting the Punch card, push both TUCK buttons.
2. Change the yarn in the Yarn feeder every third row.

*HOW TO CHANGE THE YARN

- a. Thread both yarns into the yarn tension as shown in the figure.
- b. One is placed in the Yarn feeder "A" and the other is hung on the Yarn clip of the Yarn tension unit.
- c. When changing the yarn, take the yarn from the Yarn feeder "A" and hook on the end of the Needle bed to rest. Then, thread the other colour yarn into the Yarn feeder "A".

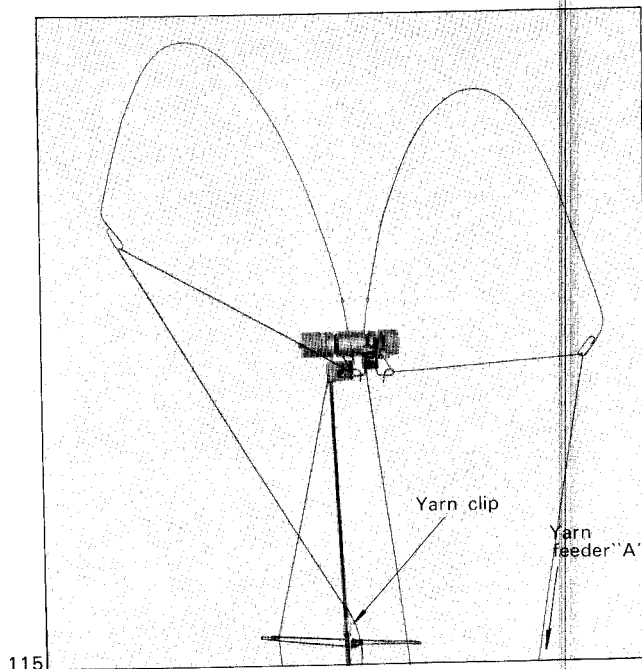

115

Skip stitch patterns

*After setting the desired Punch card, push both PART buttons.

- *In the event, an end needle is not forwarded to D position, please bring it to D position by finger before moving the Carriage.

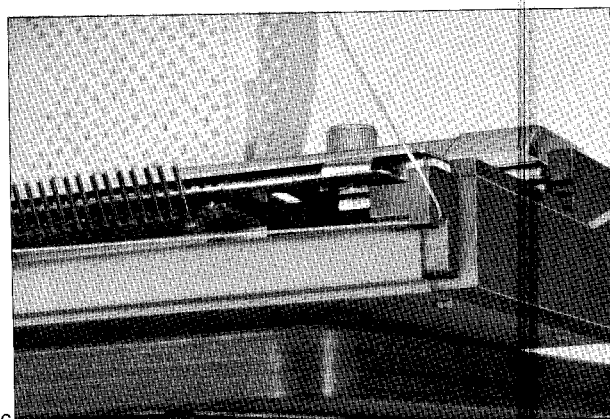

116

Two colours Skip stitch patterns

*Change the yarn in the Yarn feeder every third row the same as Two colour Tuck stitch patterns.

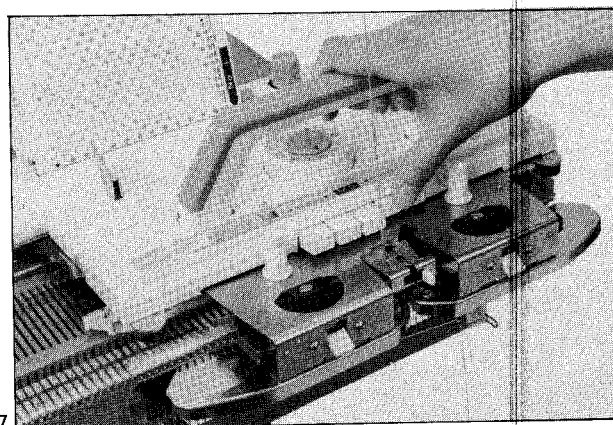

117

Fair-isle patterns

1. After setting the Punch card, push the MC button.

* Thread the yarn into the Yarn tension unit as shown in the figure.

* Be sure to thread the second colour yarn (B) into the Sub take-up spring.

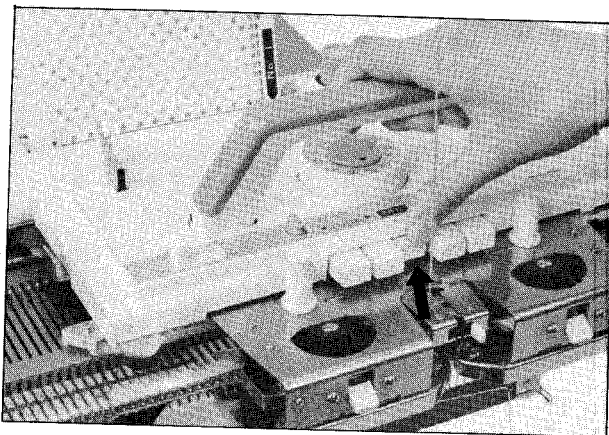

118

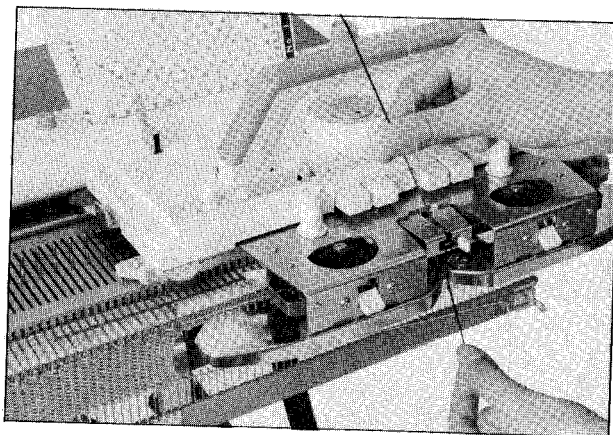

119

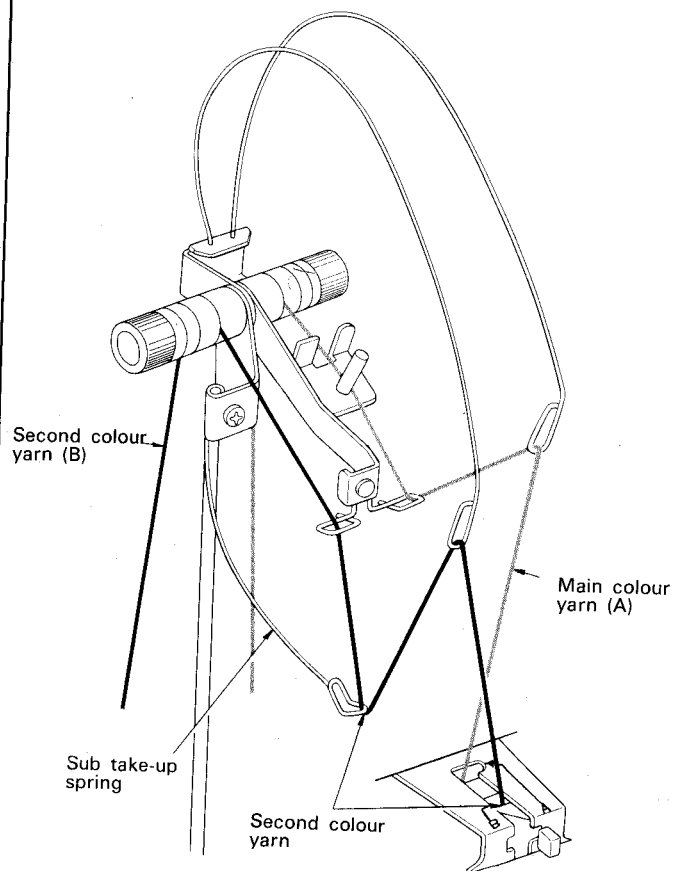

120

2. Thread the second colour yarn into the Yarn feeder "B".

* If an end needle is not forward to D position, please bring it to D position by hand before moving the Carriage.

* For Punch card No. 20 (Tulip); Change the colour of yarn in the Yarn feeder "B" to the other colour after finishing the step No. 32.

FAIR ISLE MOTIF:

Use single strand of yarn weighted with a paper clip is put into hook of B pos. needle alongside 1st raised pattern needle either side of motif.

How to weave on your machine

Weaving stitch patterns

*The best woven material effect is obtained when the yarn you are using to knit is very thin (2 or 3ply) and the weaving yarn is thick (Double or triple knit). You can also use fancy yarns for the weaving yarn.

1. Set the tension one or two sizes larger than plain knitting.
2. Cam button setting is the same as Plain knitting, and set the Punch card.
3. Set the Weaving pattern levers to "W.T."
4. Thread the weaving yarn into the Yarn tension unit.
5. You can control the tension of weaving yarn separately from the main yarn.
A tight tension (towards the +) is used for thin yarns and loose tension (towards the -) for thick yarns.

HOW TO CHANGE THE WEAVING YARN

Commencing with the Carriage on the right hand side.

1. Place the weaving yarn into the left hand weaving yarn guide and knit one row.
2. In knitting the second row, it is necessary to remove the weaving yarn from the left hand weaving yarn guide and place it in the right hand weaving yarn guide. This must be repeated every row when weaving.

*When using more than 2 colours, the additional colours should be kept in a bowl on the floor beside the machine. An extra colour can then be woven by laying the yarn by hand over the needles.
Making sure that all the latches are open.

- *A slight tension should be put on the yarn as it slides between the fingers.
- *This should be practiced on a test sample of knitting before commencing the garment.

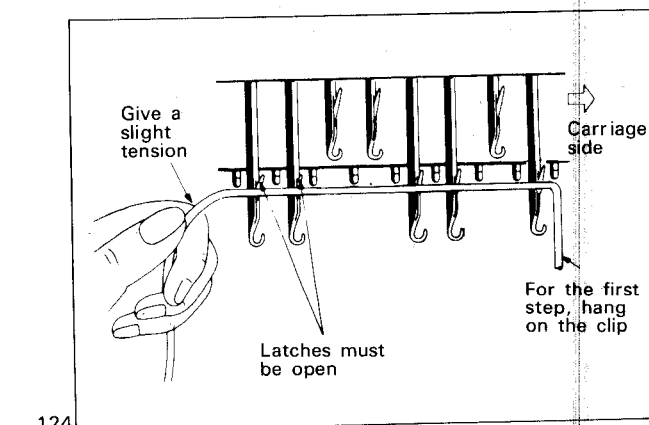
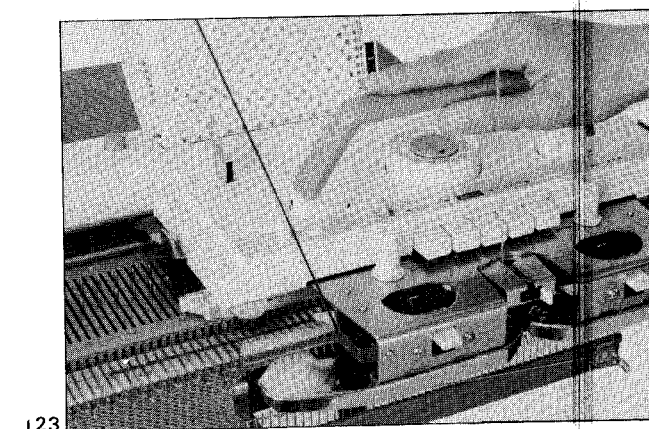
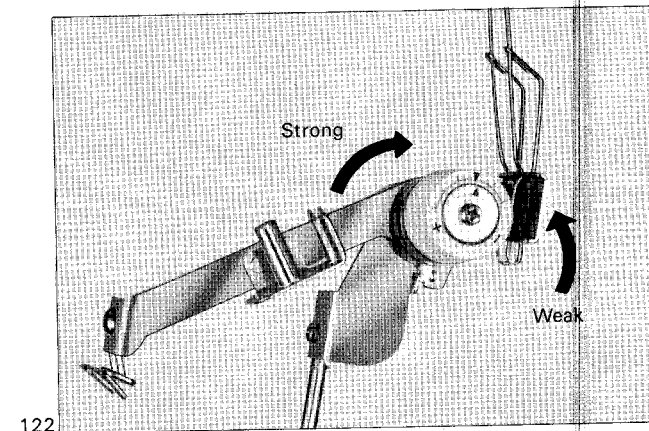
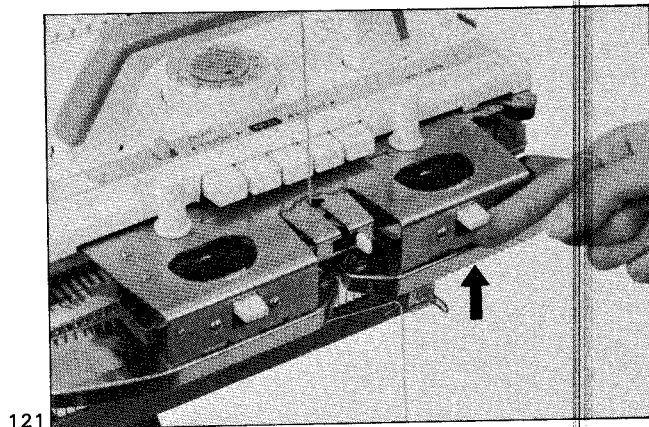

How to use the L Carriage

50

1. Remove the L Carriage from the Carrying case and set up the Handle.

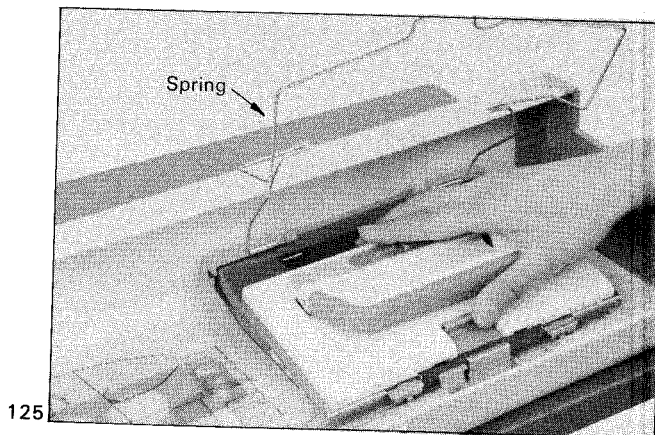

2. Remove the Extension rails from the Carrying case.

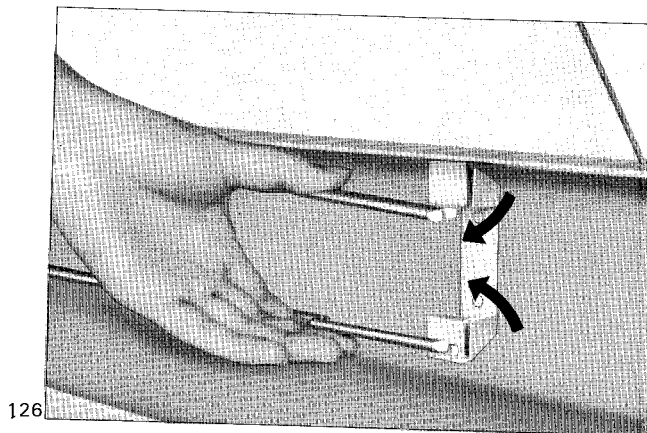

3. Insert the Extension rail into the holes (A) and (B) at the edge of the machine.

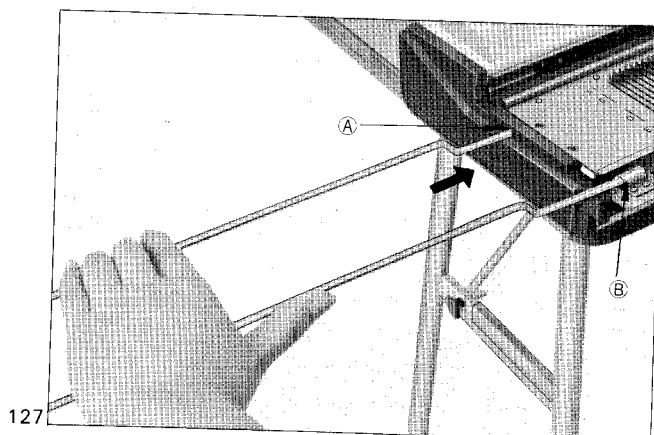

4. It is recommended that the wax block is used when knitting any synthetic yarn or cotton with the L Carriage.

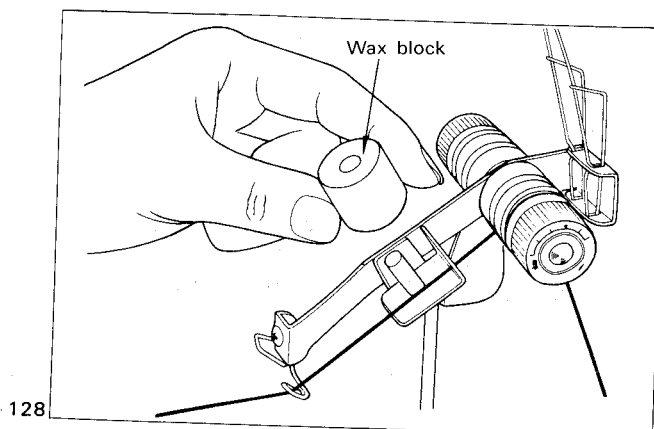

5. Knit several rows in plain stitch, and hang the claw weights onto the Cast-on comb.

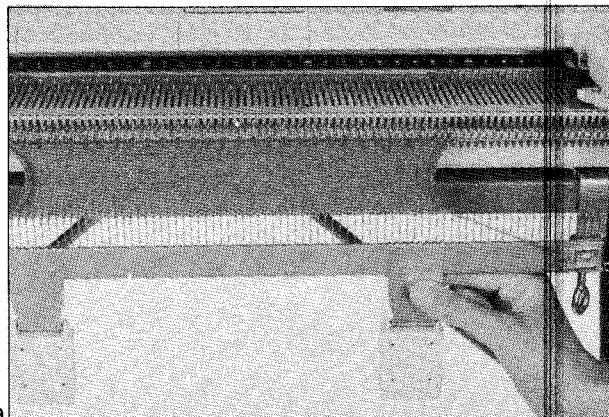

129

6. It is important therefore that no two (or more) adjacent needles are brought forward together.

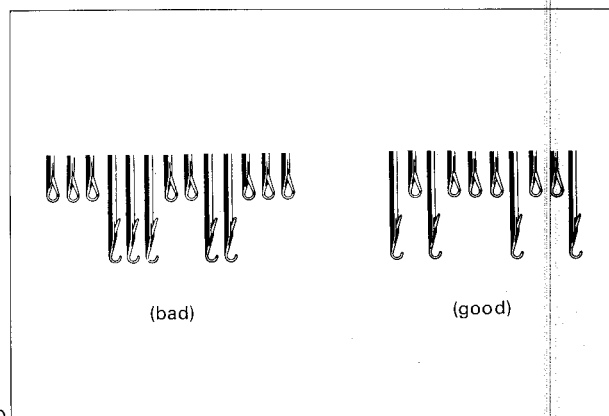

130

7. In the event that an end needle is brought forward it should be pushed back by hand to position B. You can do this without fear of the stitch dropping.



131

8. **FITTING THE L CARRIAGE**
The needles at the side of those you are using must all be in position A.
Put the L carriage on the Extension rail correctly, and slide into the rail of needle bed.

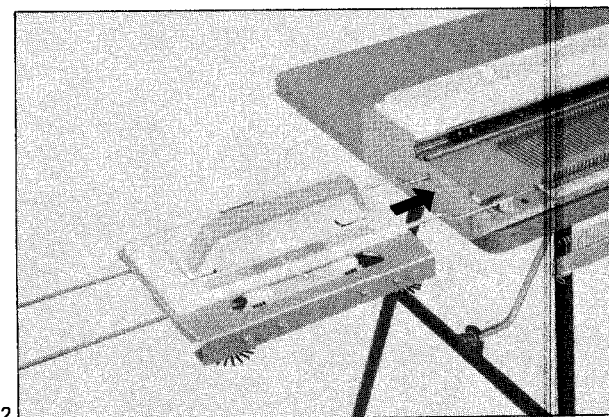

132

9. Please move the L Carriage slowly. IF THE L CARRIAGE SHOULD JAM DURING KNITTING REFER TO PAGE 61 TO RELEASE IT.

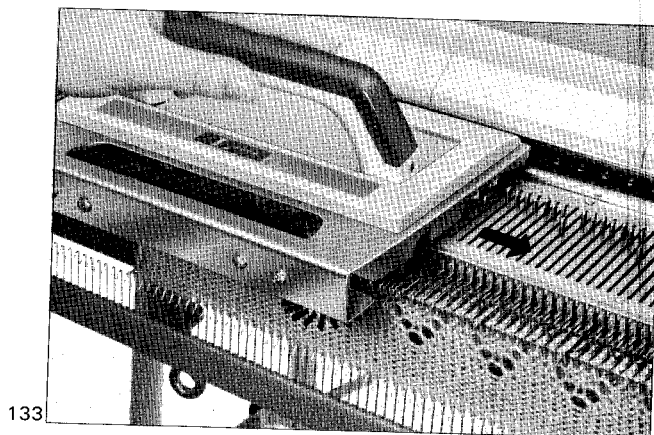

133

10. To unlock the L carriage, press the Release button at the back and release it from under the rail.

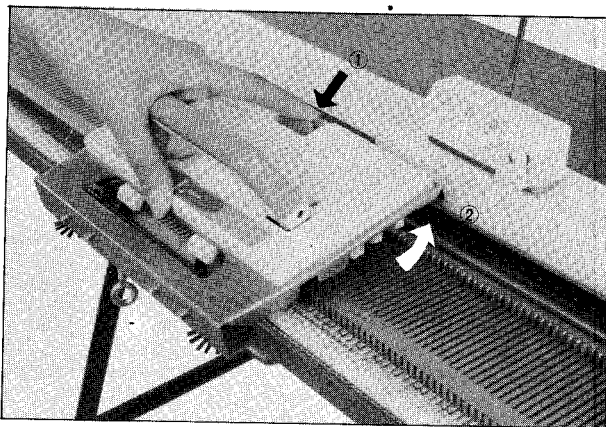

134

11. To rest the L carriage on the Extension rail, place it firmly in position as shown.

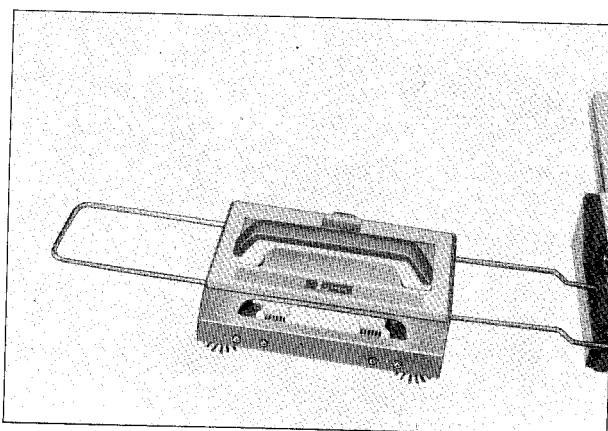

135

- * Don't move both Carriages simultaneously.
- * Carefully check the direction of L carriage and K carriage.
- * If an end needle is brought forward, push it back to position B.

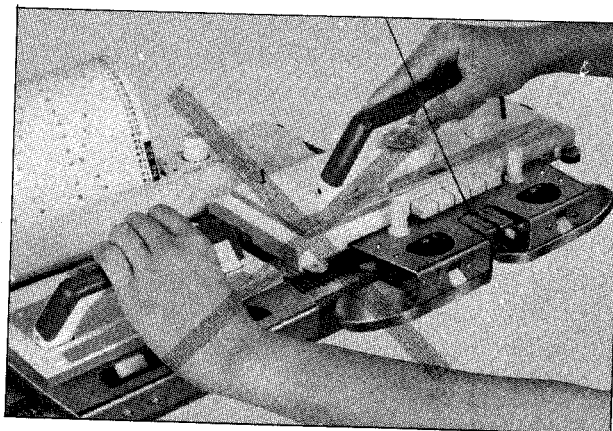

136

LACE KNITTING CARDS

There are 5 punch cards for lace knitting, and you will find the following symbols on the left side of these cards.

(1) The left red arrow means direction of L carriage.

→ Move the L carriage from left to right.

← Move the L carriage from right to left.

(2) The right blue arrow means direction of K carriage.

↻ Move the K carriage from right to left and come back to right side of needle bed. (Namely, knit two rows.)

Note; When the symbols → and ↻ are indicated at the same step, first move the K carriage, then operate the L carriage. (See Fig. 137)

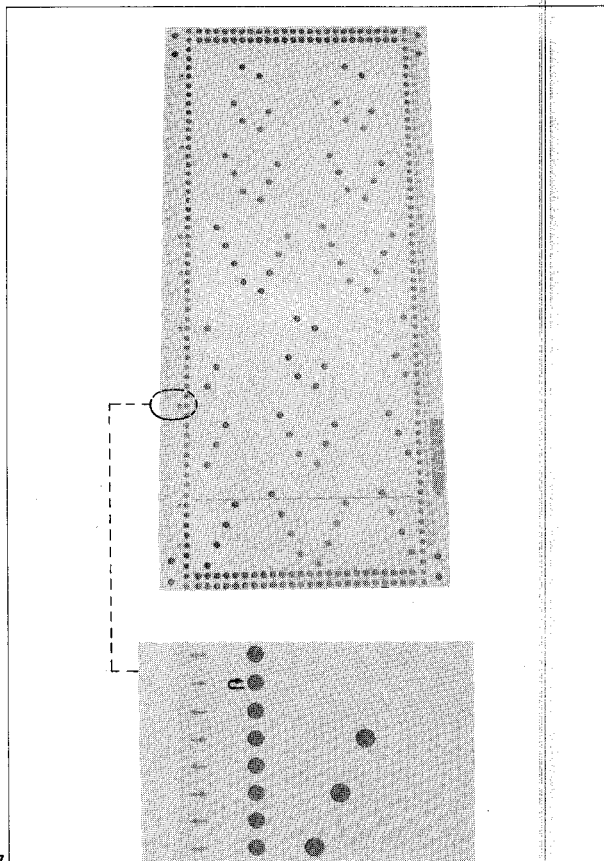

137

PREPARATION OF LACE KNITTING

(1) After knitting several rows with PLAIN, place the K carriage on the right end of the needle bed.

(2) Set the Change knob to position "N.L" (Normal or Lace knitting).

(3) Set the desired Punch card to the starting position, and set the Card lock lever to the "●" mark.

(4) For preparation of the first step, (without concerning the red arrow of the card) move the L carriage from left to right using 2 hands with a side thrust. So, the corresponding needles are brought to position D.

(5) Set the Card lock lever to the "▼" mark.

* Now you can start to knit lace pattern according to the direction of arrows.

* Don't return the L carriage until the L carriage completely passes over the working needles.

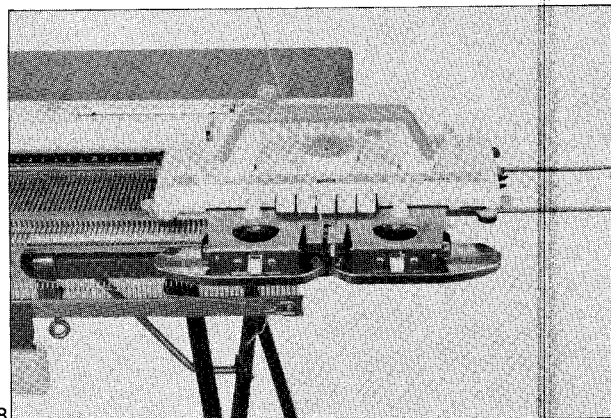

138

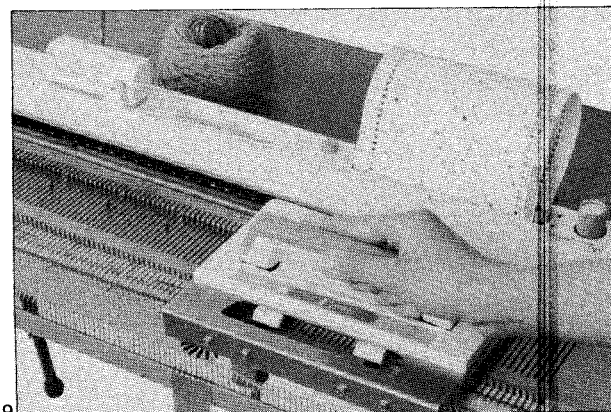

139

Partial knitting of the Lace pattern

54

(1) Set the Holding cam lever to N, and push both PART buttons.

(2) Adjust the tension dial number as shown in the Fig. 140.

140

Knitting tension	Adjusted tension
4	5
5	6
6	7

(3) Move the L carriage to select the needles.

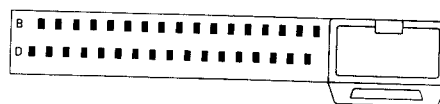

(4) Bring back the nonknitting needles to B position.

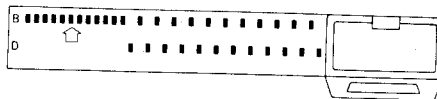

(5) Move the L carriage according to the direction of the arrow to transfer the stitches.

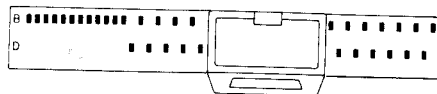

* Repeat the steps (4) and (5) as required.

(6) Bring forward the knitting needles to E position.

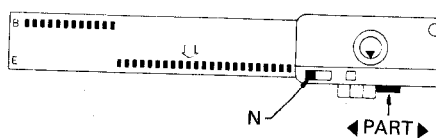

(7) Knit one row with K carriage.

* Repeat the steps (6) and (7) according to the pattern.

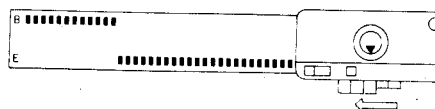

* To avoid a hole in the knitting hook the yarn to the next needle to the knitting before knitting next row.

Button-holes small

Button-holes medium

Small

- (1) Open the latches of two needles where the buttonhole is to be.
- (2) Using the one eyed transfer tool, move the stitches on the right over to the left.
- (3) Bring back the butt of the empty needle to Position B, and continue to knit.

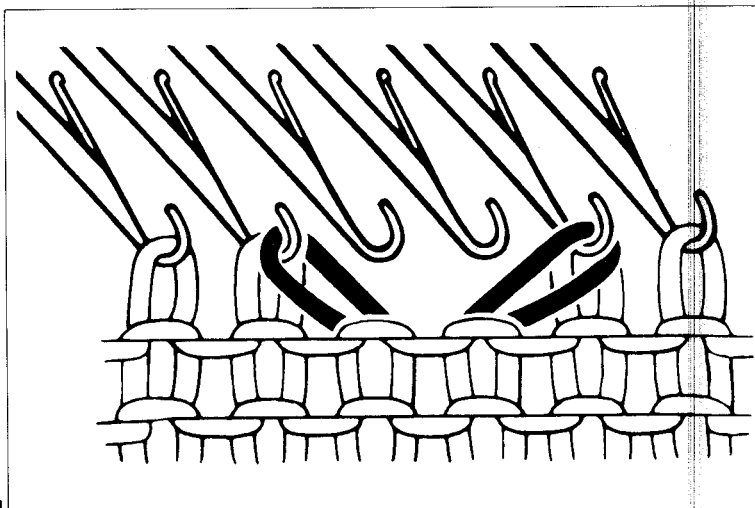

141

Medium

(1) OPEN THE LATCHES OF A GROUP OF FOUR NEEDLES.

- (2) Transfer the inner two stitches to the adjacent outer needles (See Fig. 141).
- (3) Return the two empty needles to Position B and knit one row (See Fig. 142).
- (4) The loops must be twisted by hand to form stitches (See Fig. 143).

To ensure that these needles knit on the next few rows, bring them both forward to Position E (for next 2 rows), making sure that the loops fall behind the latches.

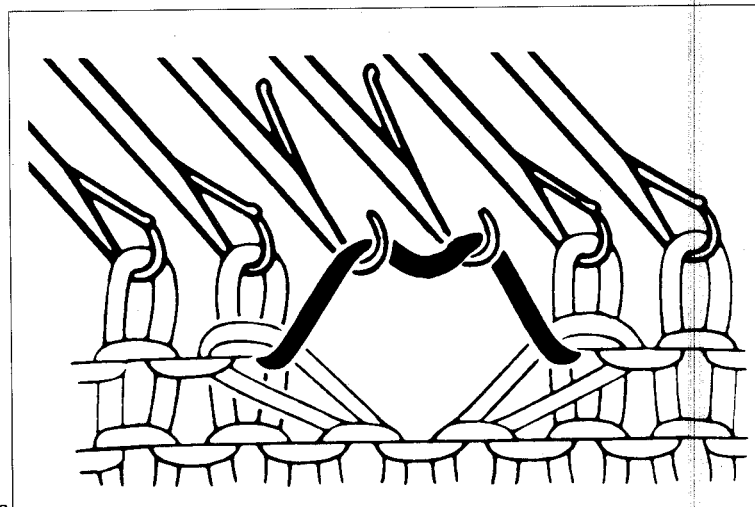

142

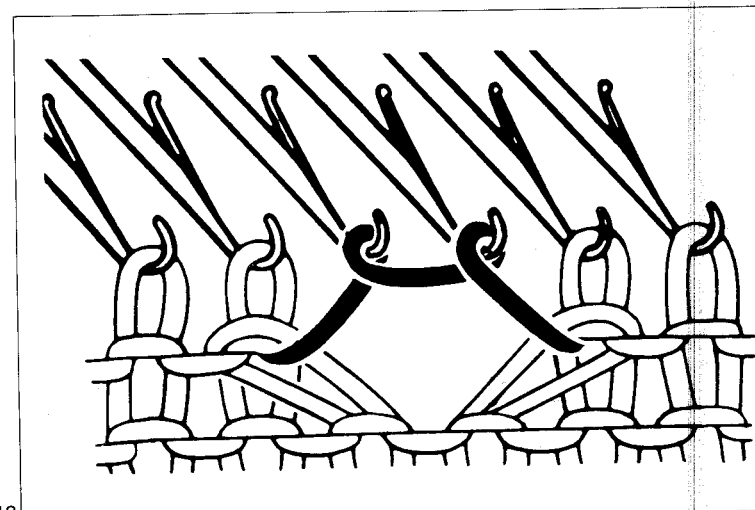

143

Button-holes Large

56

- (1) Determine the position of the buttonhole. Purl the stitch adjacent to where you want the buttonhole to start. (Fig. 144).
- (2) Catch the purl half stitch and bring it forward onto the latch hook (See Fig. 145). With this as your first stitch, crochet through the next adjacent stitches of the buttonhole—thus casting off (See Fig. 146).
- (3) Transfer the stitch off the latch hook, onto the next adjacent needle (See Fig. 146).
- (4) Knit one row (H.C.L. on N). The wool will loop over the empty needles (See Fig. 147).
- (5) Starting from the end where the bottom part was sealed off—wind the wool around each needle individually. If there is any left over (this will depend on the tension you are using) then wind an extra loop around each adjacent needle (See Fig. 147). Do not wind too tightly.
- (6) Raise the needles with the wound loops and a few adjacent needles on either side to Position E. Make sure the loops fall behind the latches. Continue to raise these needle (if it does not interfere with the pattern) for the next two or three rows of knitting.

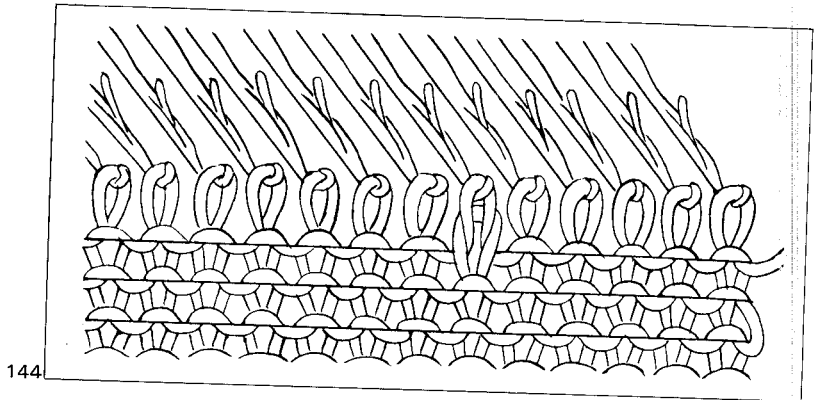

144

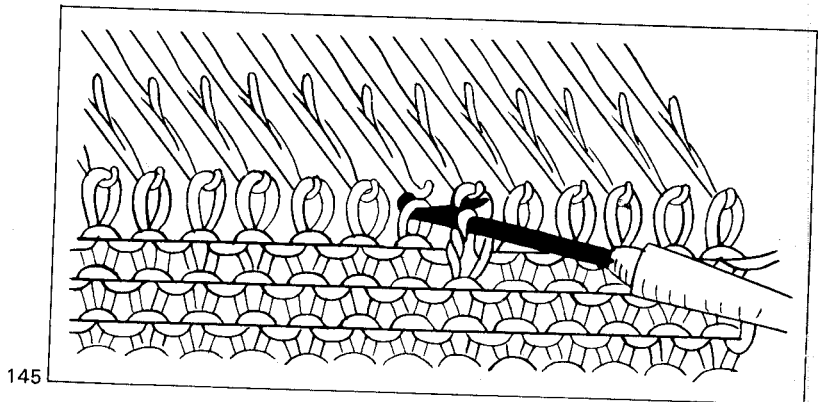

145

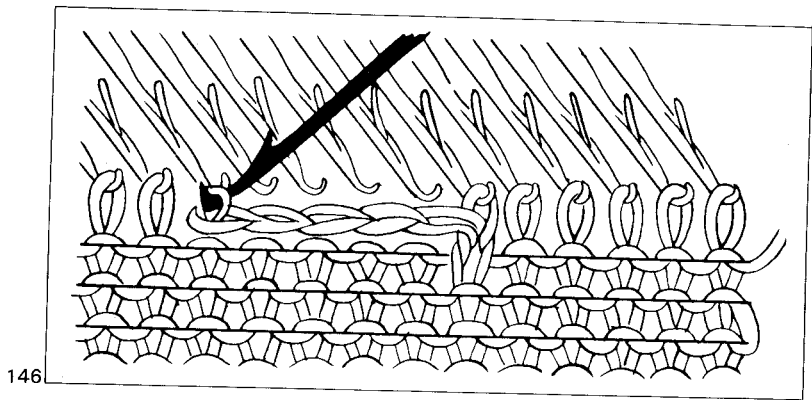

146

ALTERNATIVE METHOD FOR LARGE BUTTON-HOLES

Bring forward the number of needles needed for the button hole to "D" position making sure the stitches pass behind the latch. Place a length of contrast colour yarn in the hooks of these needles and knit the stitches by pulling the needles back to B position. Continue knitting until the garment is completed. The buttonhole can be finished by stitching, and the contrast wool taken out.

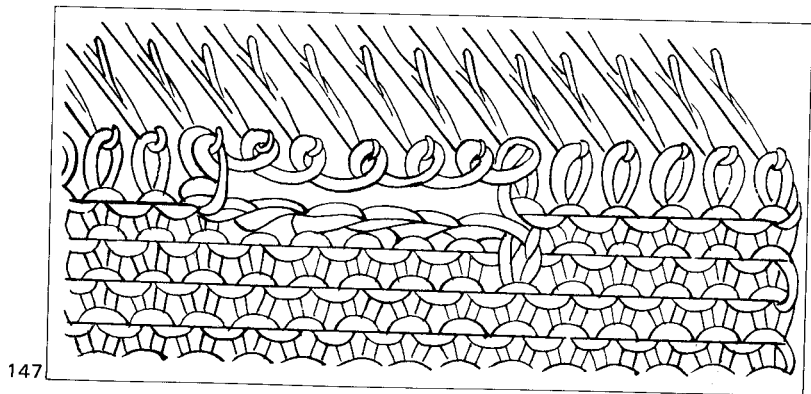

147

Making a vertical buttonhole

How to knit a pocket

57

Making a Vertical Button Hole

Knit up to the row where the buttonhole starts. If the carriage is on the right side of the needle bed, knit the right side of the buttonhole first.

- (1) Set the H.C.L. to Position H.
 - (2) Determine where the buttonhole is to be and bring forward to Position 'E' all the needles on the left of the buttonhole.
 - (3) Knit 6 rows. (If a larger buttonhole is desired, knit as many rows as is necessary.)
 - (4) Break the yarn; take the carriage off the needle bed and replace it on the other side.
 - (5) Return the needles that were in position 'E' to Position 'B' and bring forward the needles on the right to Position 'E'.
 - (6) Knit the left side of the buttonhole, the same number of rows as for the right side. After you have completed the same number of rows, set the H.C.L. to Position N and continue to knit.
- Instructions are given for the carriage on the right side of the bed.

How to knit a Pocket

- (1) Determine the position of the pocket, and bring forward to Position 'E' all the needles on the left of the pocket.
- (2) Set the H.C.L. to Position H.
- (3) Knit one row and bring forward to Position 'E' all the needles on the right of the pocket.
- (4) Knit one row again.
- (5) The carriage is now on the right and you can knit the amount of rows required for the pocket. Move the carriage across slowly with one hand and put the other hand behind the fabric and pull the knitting down slightly. Finish the completed pocket with the carriage on the right.
- (6) Push the needles on the left back to Position 'B' taking care not to let the stitches fall over the latches.
- (7) Knit one row, and set the H.C.L. to Position N.
- (8) Continue knitting the garment. The pocket can now be pulled through to the side of the fabric facing you. To complete the pocket sew up (or weave) the stitches at the sides.

148

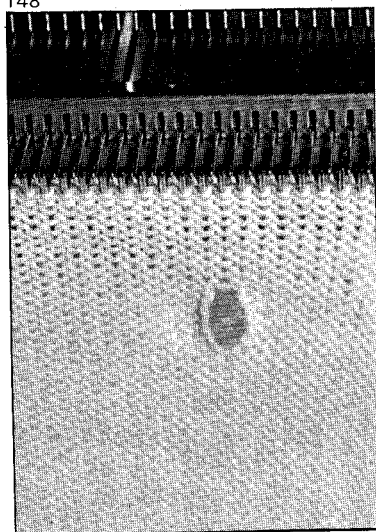

149

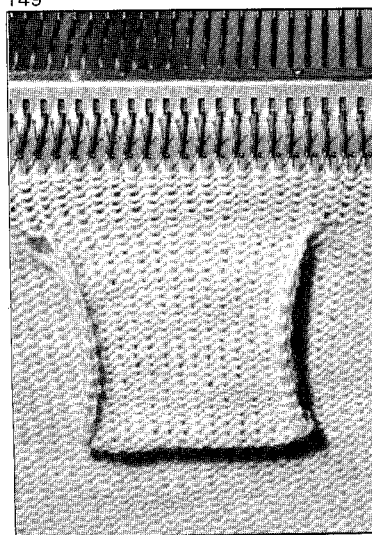

Shaping a 'Vee' neck

58

Knit the fabric to the row where the 'V' neck commences. The instructions are written to start with the carriage on the right side of the bed. If the carriage is on the left then read LEFT for RIGHT and vice versa.

- (1) Place the H.C.L. on H.
- (2) Bring forward to position 'E' all the needles on the left side of the centre 'O'. These needles will not knit until the right side is completed. (If you wish you may take them off onto a knitting needle and replace them later).
- (3) Transfer the first stitch on the right of 'O' to the adjacent needle on the right (in Pos. 'B') Return the empty needle to Pos. 'A'.

N.B. FOR FULLY

FASHIONED—transfer both first and second stitches onto the second and third needles, and continue transferring two at a time.

- (4) Knit two rows.
- (5) Continue decreasing one stitch every two rows until you have the required number of stitches left for the shoulder. Bind off these stitches and break the wool.
- (6) Return all needles at left to Pos. 'B' by putting three at a time onto a transfer tool, and slipping the stitches inside the needle hooks (i.e., not behind the latches). Knit this side identical to the other.

KNITTING THE BAND TO THE 'V' NECK

Bring forward to Position 'B' the number of needles required for HALF the neck and back of garment. Open the latches of all these needles.

Set the carriage and machine dials as for Plain knitting.

With the wrong side of work facing you, and using the one eyed transfer tool, pick up the 1st stitch nearest to the 'V' onto the first needle nearest to the carriage.

Now continue to raise all the stitches from the half 'V' onto the empty needles. (You may prefer to have the band tighter and therefore raise all the stitches onto $\frac{1}{3}$ the corresponding number of needles. To do this, miss out every 4th stitch and raise every 5th stitch onto every 4th needle).

IF YOU WISH TO DO THE NECKBAND IN ONLY TWO PIECES THEN RAISE HALF THE STITCHES FROM THE BACK OF THE GARMENT ONTO THE NEEDLES AFTER RAISING HALF THE NECK STITCHES.

With the same yarn knit one row across (N.B. All needle butts should be in Position 'B').

YOU CAN NOW KNIT THE BAND

The bottom end of the band should be mitred (for the V shape), by decreasing at the 'V' end until the hem is halfway through.

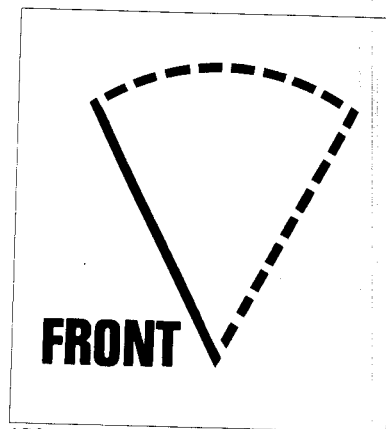

Now increase in reverse order so that when the band is completed you have the same number of stitches on —as when started.

REPEAT THE SAME PROCESS FOR THE OTHER SIDE OF THE NECK STARTING AT THE 'V'.

FAIR ISLE: NECK SHAPING:

Note Row counter number and pattern row on card. Carriage on the right. Knit off manually with waste yarn and push into A position, $\frac{1}{2}$ or required number of stitches furthest from carriage. Knit and finish one side. Bring stitches on waste back into B position. Press in both Part Buttons and have Change Knob on N L. Take carriage from right to left. Change Knob onto K C; turn card onto number noted at the beginning of shaping, lock card. Take carriage from left to right to select pattern needles. Unlock card; set row counter to beg of shaping row and continue as before reversing all shapings.

Shaping a round neck

Shaping a square neck

Round neck

Instruction are given for the carriage on the right side of the needle bed.

- (1) Place the H.C.L. on Position H.
- (2) Bring forward to Position 'E' all the needles on the left side of the centre 'O'.
- (3) The decreasing of the stitches is done by bringing forward to Position 'E', the needles you wish to decrease. Start with the needles in Position 'B' on the right of 'O' and knit two rows each time you bring needles forward.
- (4) Decrease in this manner until you have the required number of stitches left in Pos. 'B' for the shoulder.
- (5) Bind off these stitches and break the yarn.
- (6) Return the needles on the left back to Position 'B' and repeat as above, from 3 to 5. Remember to leave the same amount of needles for the shoulder. Bind off these stitches.
- (7) Place the end stitches of the round neck onto the knitter.
- (8) Place the carriage on the left and thread the yarn feeder. H.C.L. on Position N.

KITTING THE NECK BAND

- (9) Knit the first half of the hem (approx. 5 rows) on a normal tension for that yarn.
- (10) Knit one row on a tension 3 numbers higher. This will ensure that the fold will be flat.
- (11) Knit the other half of the band on the same tension as used in No. 9. (N.B. It must be the same amount of rows as the first half).
- (12) Using the transfer tool, raise the stitches from the end of the round neck onto the needles. Take care to raise each stitch onto the corresponding needle to obtain a perfect round effect.
- (13) When all the stitches have been raised, bind off the double stitches in the normal way.
N.B. Seal the stitches by hand very loosely, to allow for the neck to fall back into place after removing the knitting from the machine.

Square neck

Cast off the needles in the centre, for the width of the neck, using the same wool as that for the garment. Return needles to Position 'A'.
On the opposite side to the carriage bring forward all the needles to Position 'E'. Set the H.C.L. to H. Knit the required number of rows to complete the side nearest the carriage. Cast off and return the needles to Position 'A'. Set H.C.L. to N and knit other half identical to first.

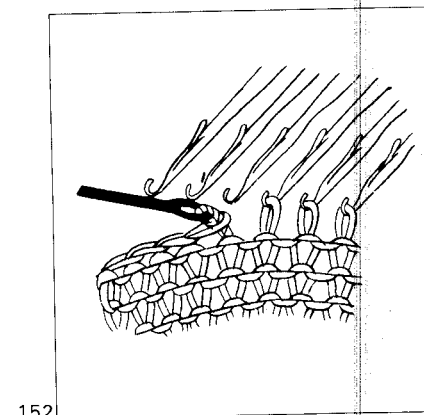
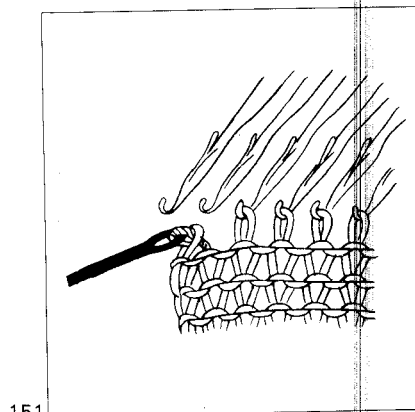

Short row designing

60

SHORT ROW DESIGNING

This method of shaping has endless possibilities and is used most frequently for:

Turning the heel of socks; pockets; horizontal darts; circular piece-yokes, skirts and zig-zag designs.

Set the H.C.L. to Position H, then put one or more needles in Position 'E', so that these needles stop knitting and hold the stitches for further use.

TWO COLOURS DIAGONAL KNIT (USING SHORT ROW METHOD)

- (1) Start with the carriage at the right and the H.C.L. on Position H.
- (2) Raise two needles on the left to Position 'E'.
- (3) Knit one row to left and pass the yarn under the stem of the needle in Position 'E' on the right. Knit one row to the right.
- (4) Continue raising two needles and knitting 2 rows as above, until all needles are in Position 'E'.
- (5) Change the yarn; remove carriage from the right side and place on the left side of knitter. Starting at the left push into Position 'D' two needles at a time, and knit one row to the left and one to the right. (Reversing the previous process until all needles are back in knitting position.)

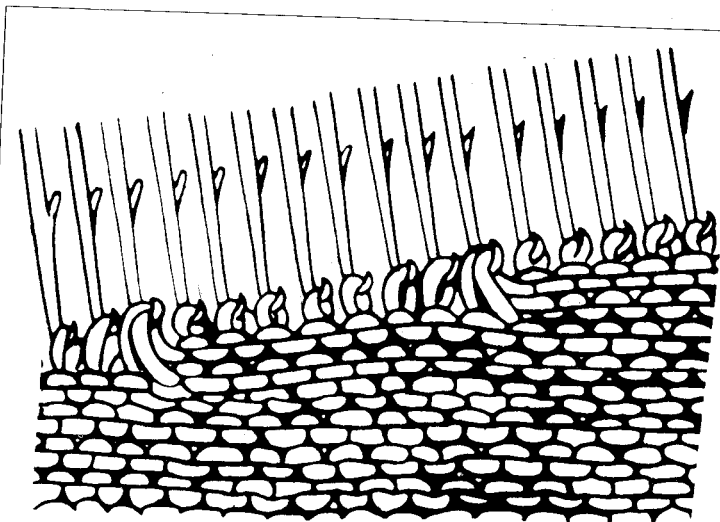

153

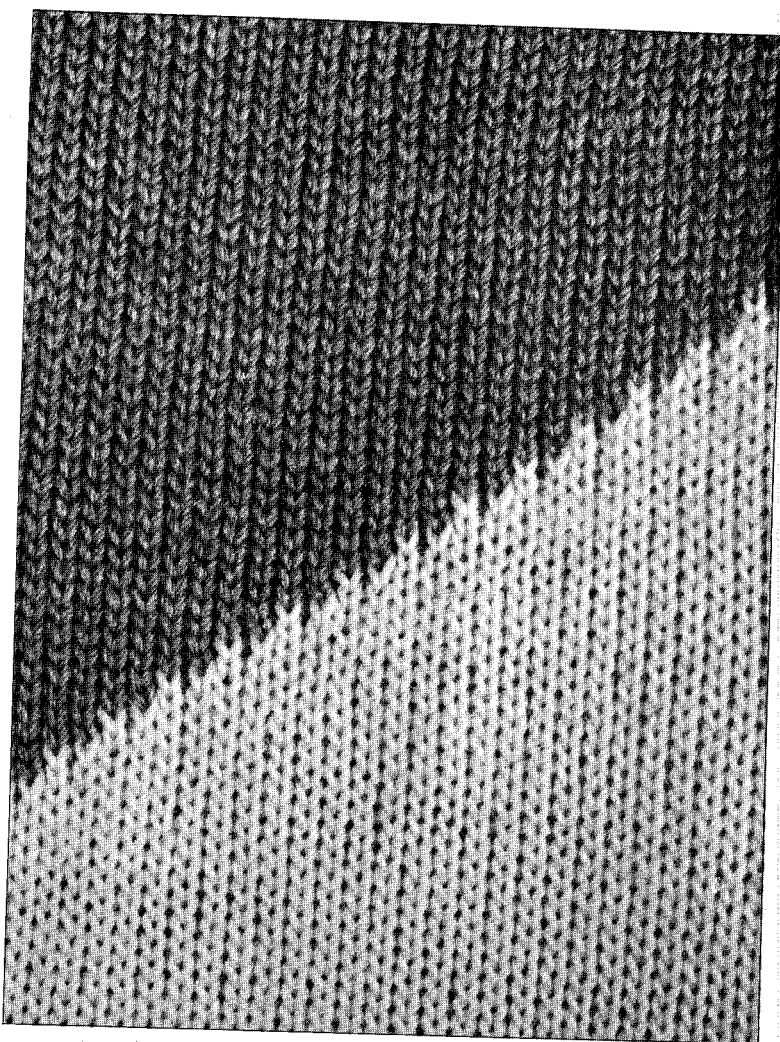

154

How to correct the lace knitting

IF THE 'L' CARRIAGE SHOULD JAM

Push the Release button of the L carriage, and remove the L carriage from its jammed position.

If the 'L' carriage is caught with the needles, take care in removing it.

After removing the 'L' carriage, you can knit according to the following steps.

- (1) If you see needles caught with each other, separate them by lifting their tips.
- (2) If stitches are caught on two needles as shown by (a) in above figure, pull selected needles (b) toward you and push them back together with needles (c) to position 'B' in order to transfer the stitches.
- (3) For other part, transfer the stitch of selected needles (b) with the transfer tool to the adjacent needles. (For use of the transfer tool, see page 26).

HOW TO UNRAVEL THE LACE KNITTING

(1) Operate the L carriage and rest it at the left end of the needle bed.

(2) If there are transferred stitches, return them to original needles by using the transfer tool.
(See Fig. 157A)

(3) Unravel two rows. (The end of yarn will be at right side of the garment.)

(4) Rewind the Punch card to the last ◀ mark.

(5) Repeat the steps (2) to (4) as required.

* When you restart to knit, first move the K carriage, then operate the L carriage.

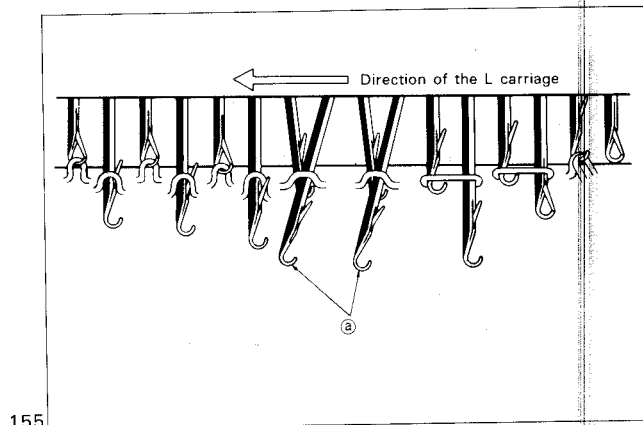

155

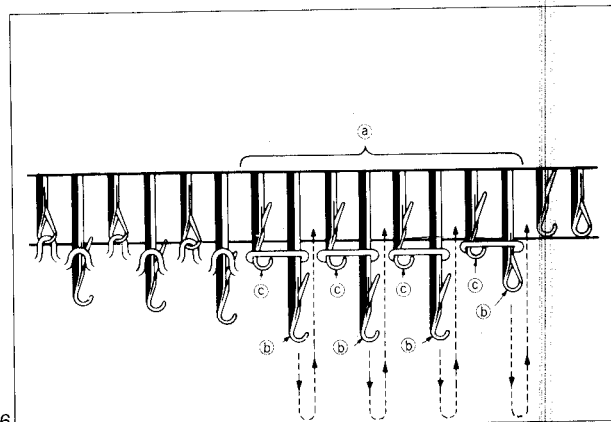

156

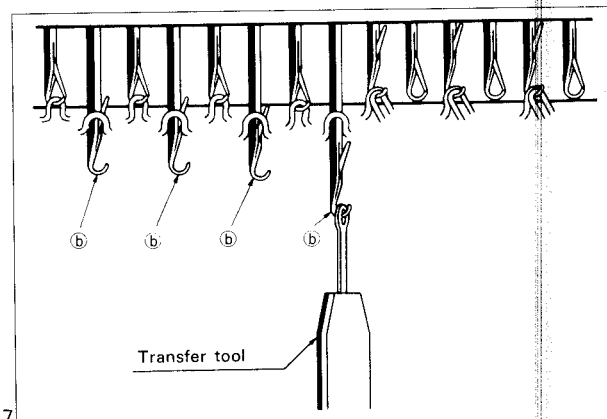

157

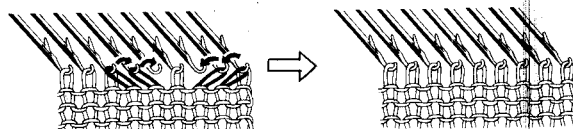

157A

If you make mistakes in pattern knitting using a Punch card.....

How to correct the mistakes

62

*If the Carriage has already started to knit and the Punch card has rotated. (You will notice the arrow mark on the right end of the machine. If this arrow mark indicates the same direction as the K carriage has been moved, the Punch card has been rotated).

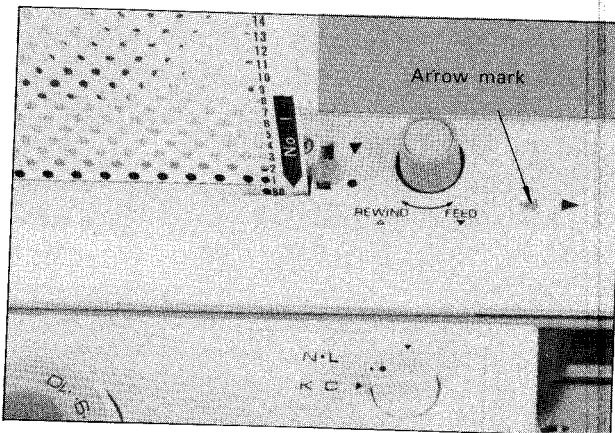

158

(1) Set the Card lock lever to "●", and change knob to N.L.

(2) Remove the Sinker plate and Carriage, and place it back to the side from where that row commenced. (How to remove....., see on page 18.)

(3) The stitches which are behind the latch of the needles must be returned into the hook of the needles.

Then, push back all needles to B position. (Use the Transfer tool.)

(4) Unravel the last half row.

(5) Unravel the incorrect rows.

(After unravelling, set all needles in B position.)

(6) Rewind the Punch card.

A. If the number of unravelled rows is an odd number.....

A-1 Rewind the Punch card and row counter the same number of rows as unravelled.

A-2 Depress both PART buttons and set the Change knob to KC.

A-3 Move the Carriage to opposite side to select the needles.

A-4 Set the Cam button, etc. for the pattern which you are knitting.

A-5 Thread the yarn into the Yarn feeder, and set the Card lock lever to "▼"

A-6 Continue the knitting.

B. The number of unravelled rows is an even number.....

B-1 Rewind the Punch card and row counter the same number of rows as unravelled.

B-2 Depress both PART buttons, and move the Carriage to opposite side. (The Change knob was previously set to N.L position.)

B-3 Set the Change knob to KC, and move the Carriage to starting side to select the needles.

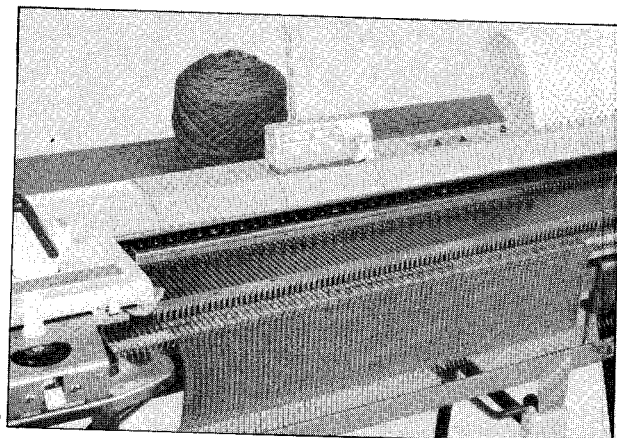

159

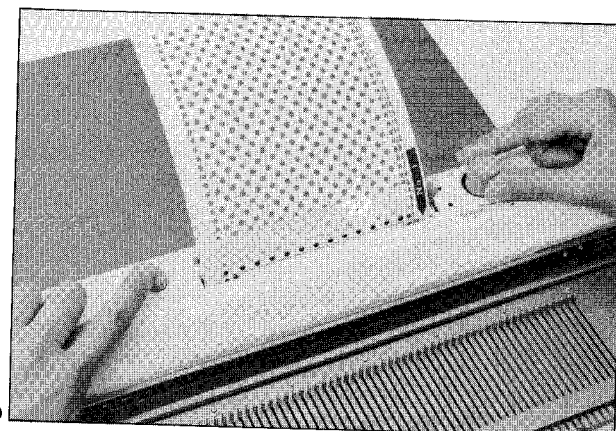

160

B-4 Set the Cam buttons, etc. for the pattern which you are knitting.

B-5 Thread the yarn into the Yarn feeder and set the Card lock lever to "▼".

B-6 Continue the knitting.

*If the Carriage has not started to knit yet, and the Punch card has not rotated.

- (1) Unravel the incorrect rows.
- (2) Rewind the Punch card and row counter the same number of row as unravelled. (Refer to the instructions for rewinding the Punch card.)

*If you want to move the Carriage without knitting, you must set the Change knob to "N.L" and push in both PART buttons.

NB though the Carriage does not knit, the Punch card will be rotated if the setting of the Change knob is "KC".

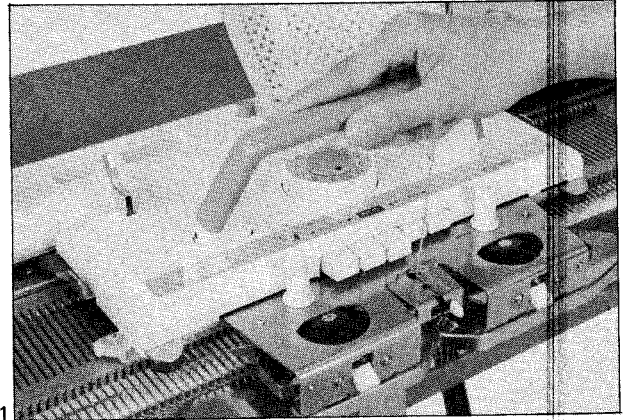

161

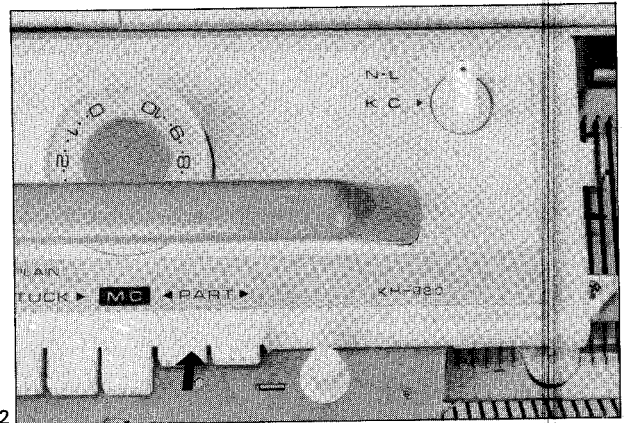

162

* If the yarn is wound around the wheel brush of the Sinker plate, remove the Sinker plate from the Carriage, then take off the yarn. Don't move or remove the Carriage to avoid the Punch card rotating.

REPLACING A BENT OR BROKEN NEEDLE

- (1) Push either side of the felt bar with the end of the latch tool until it comes out.
- (2) Withdraw it by hand from the knitter until the needle you wish to change is free.
- (3) Pull the needle forward as far as it will go. Push down the hook of the needle until shank end of the needle rises clear of the needle bed.
- (4) Grasp the shank end and draw it out backwards.
- (5) Replace it with a new needle by holding it with latch opened. Push the felt bar back into place.

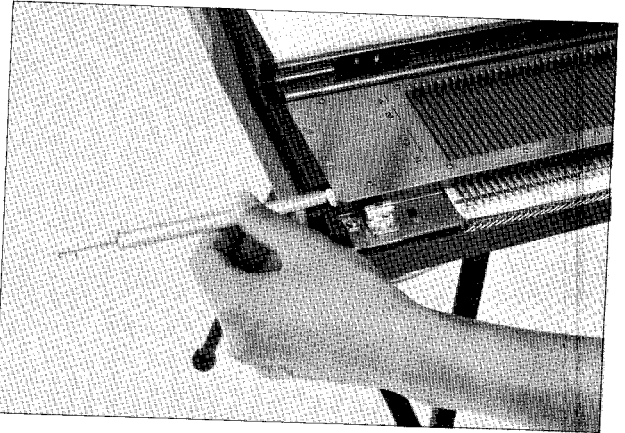

163

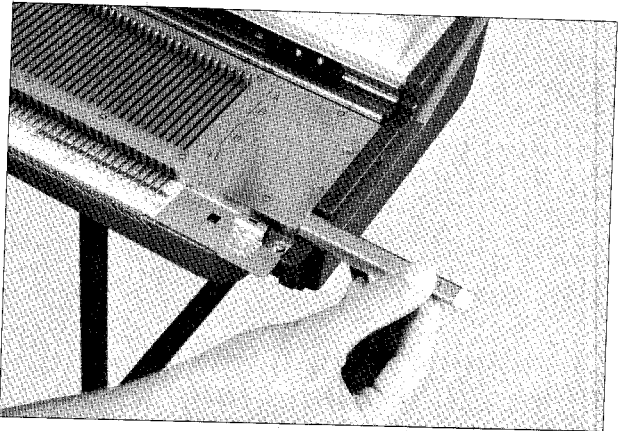

164

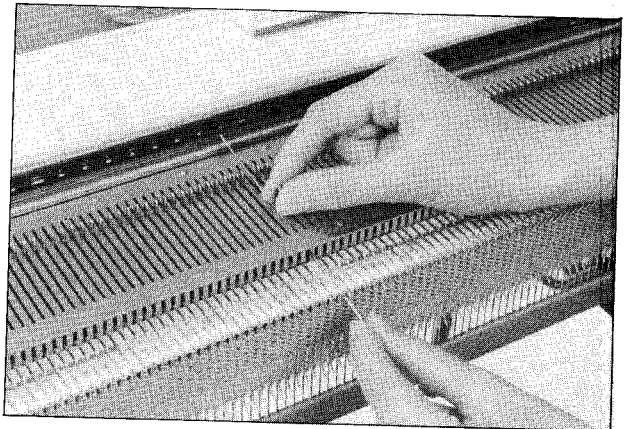

165

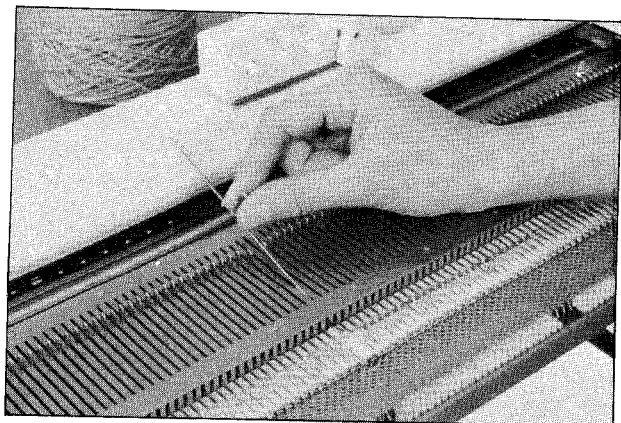

166

ALL THE INSTRUCTION ON THE MACHINE IS NOW FINISHED AND YOU SHOULD GO BACK AND PRACTICE THE THINGS YOU ARE NOT SURE OF.

CLEANING AND OILING.

Before and during use.

For best results your knitter must be kept clean and the carriage regularly oiled.

CARE OF MACHINE

1. Remove carriage from needle bed.
2. Brush off all fluff that has gathered on the working parts underneath the carriage.
3. Oil runners on carriage and sides of all cams. Main cams under carriage should be oiled whenever a drag is felt when using carriage.
4. Clean your knitter of fluff and excess oil each time you have finished knitting. Oil before using.
5. Keep machine covered at all times when not in use to prevent dust.
6. If carriage jams, never force it along, as it will not only bend or even break needles—it can damage the needle grooves.
7. Replace any bent needle or needles with latches that do not sit flat back against the needle shaft.

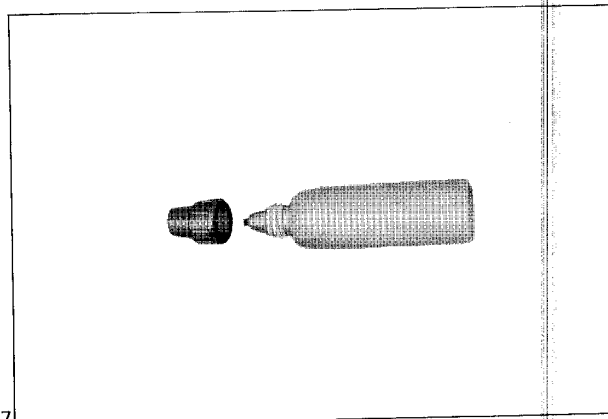
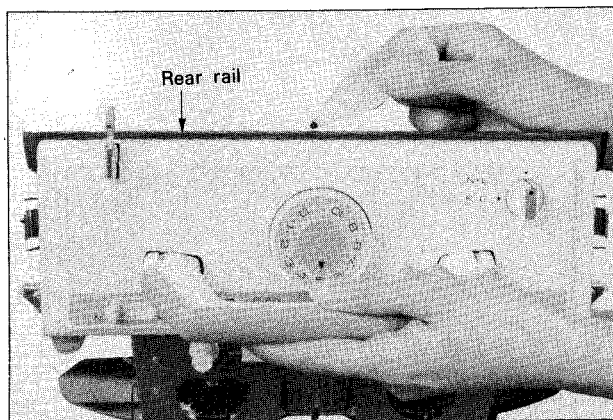

167

YOU SHOULD CLEAN AND OIL YOUR MACHINE BEFORE USING IT EVERY TIME.

Always leave a light film of oil on all parts between the rails under the carriage.

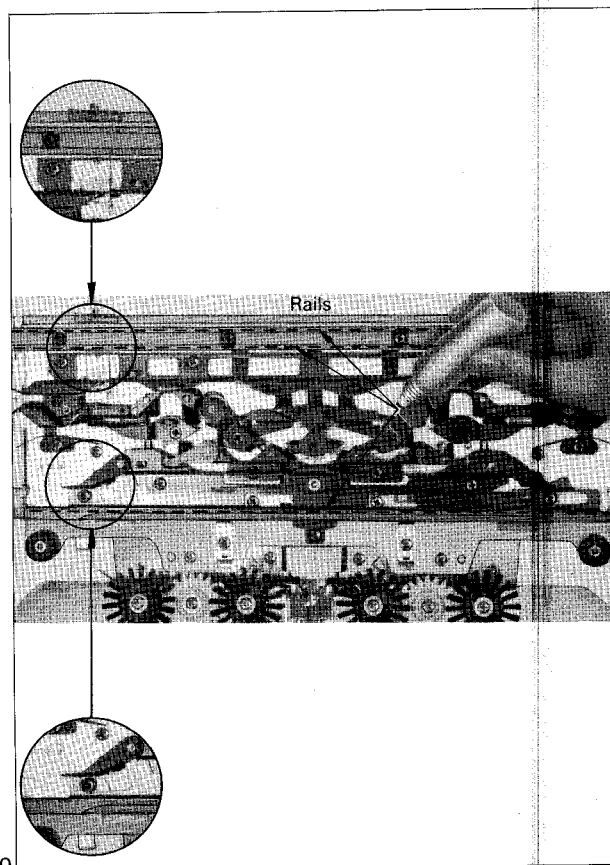

170

Folding up the knitter

66

- (1) Remove the extension rails (lift up and pull it.)
- (2) Replace the extension rails in the upper case as shown in figure.
- (3) Fold up the handle of the L carriage and replace the L carriage as shown in figure. Then, close the spring.
- (4) Replace the cast on comb in the case.
- (5) Fold up the automatic yarn tension unit Remove the automatic yarn tension unit. see Fig. 175 to 178.

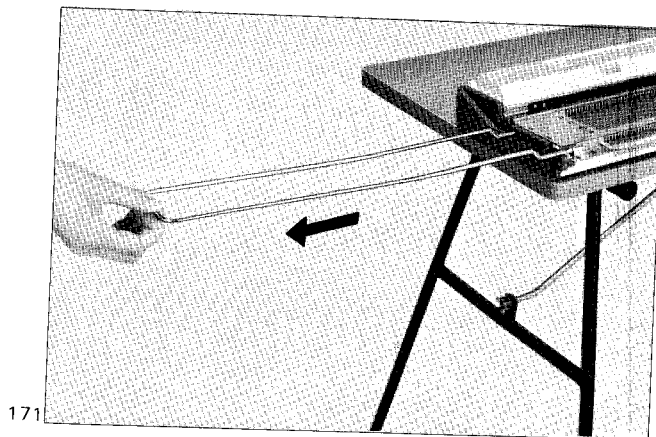

171

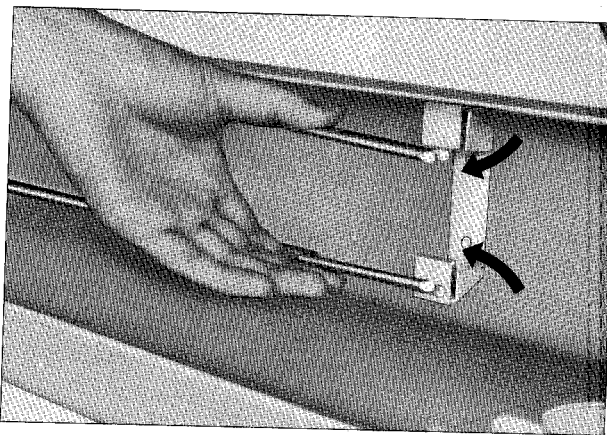

172

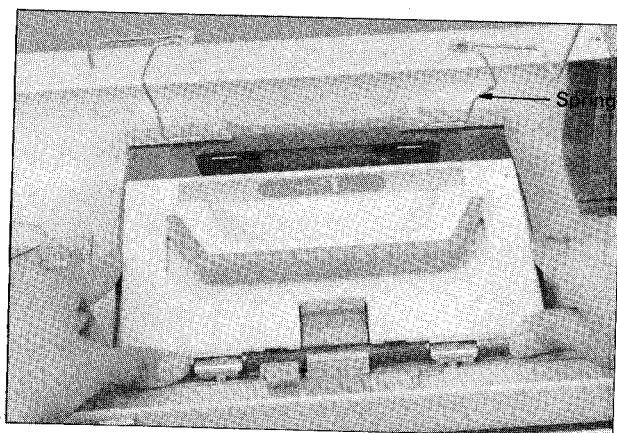

173

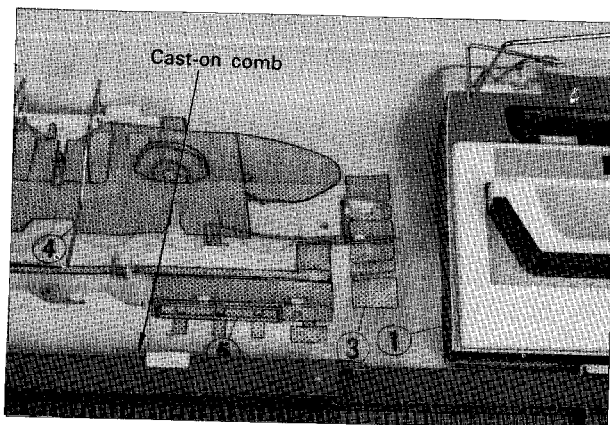

174

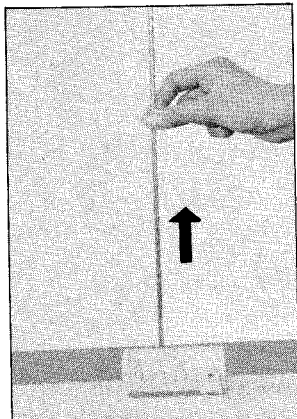

175

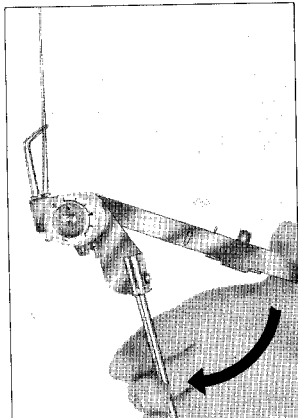

176

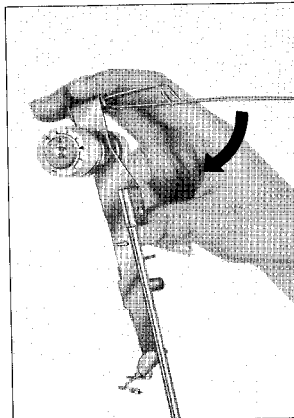

177

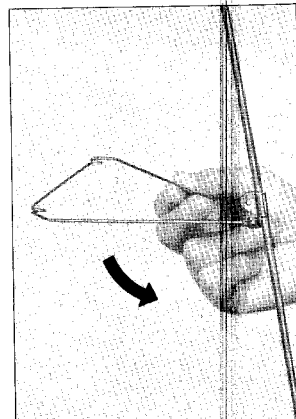

178

(6) Replace the automatic yarn tension unit as shown in figure. (Fit the head A of automatic yarn tension unit under the clasp B of the case.)

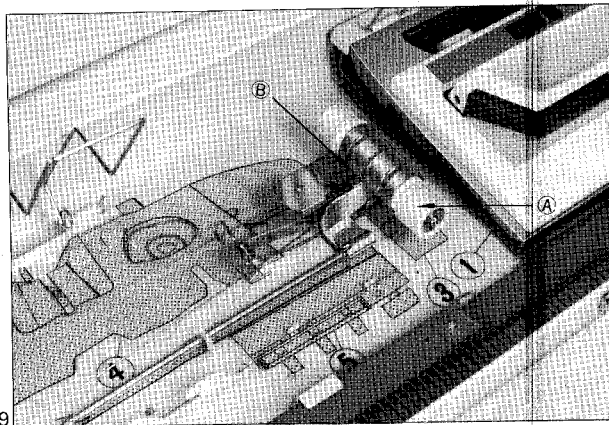

179

(7) Place the yarn tension rod and the take-up spring beside comb and put them inside of hook C.

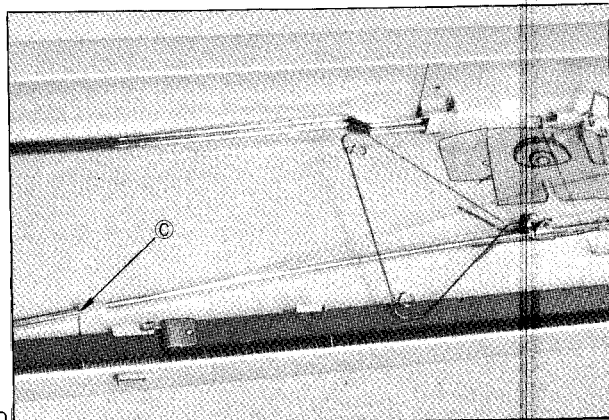

180

(8) Place the sinker plate as shown in figure and close the spring.

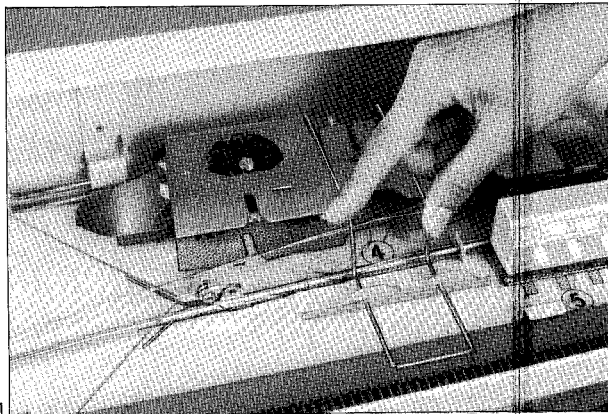

181

(9) Place the row counter as shown in figure.

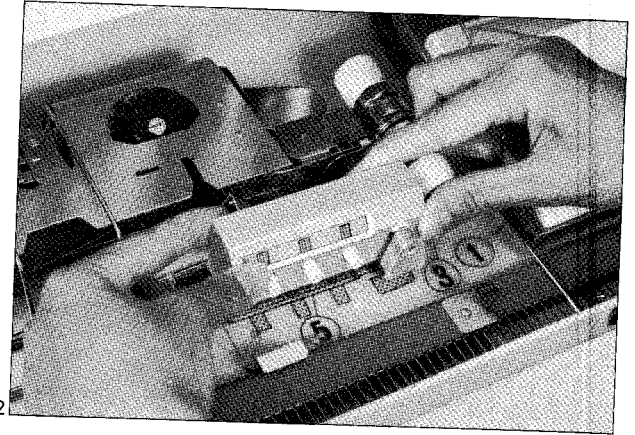

(10) Take out the carriage lock from the accessories box and lock carriage on the left end of the needle bed. Fold up the handle of the carriage.

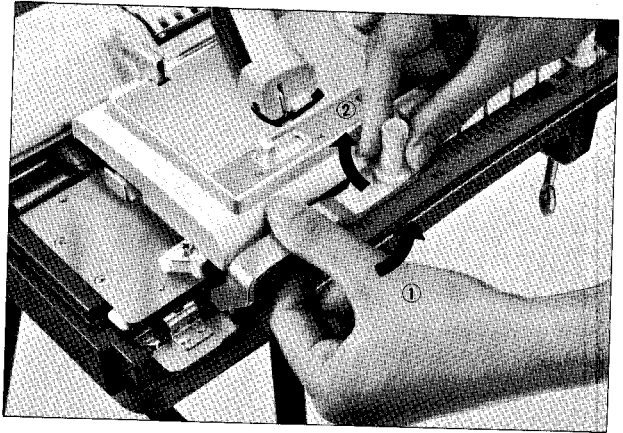

(11) Remove the table clamps and replace them in the accessories box.

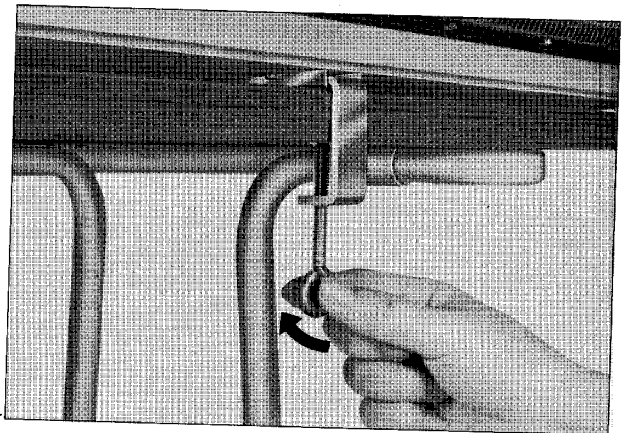

(12) Replace all accessories in the accessories box.

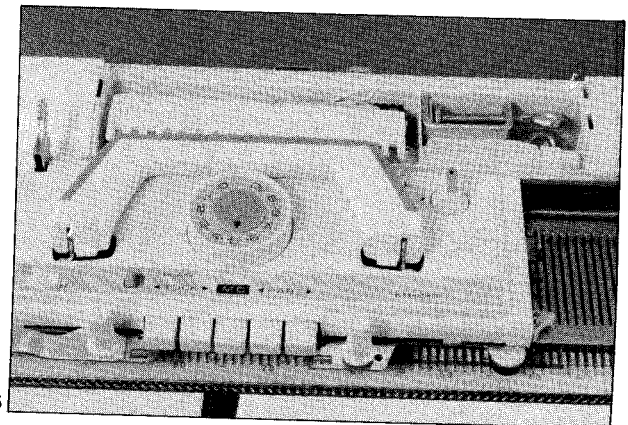

(13) Put the lid for accessories box.

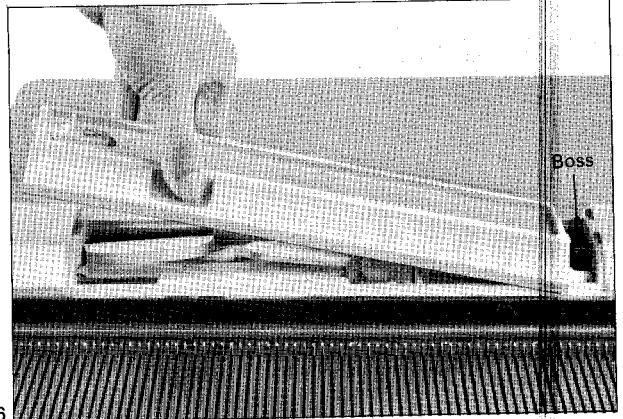

186

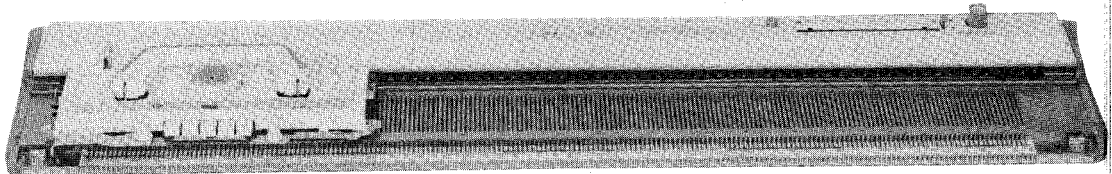

187

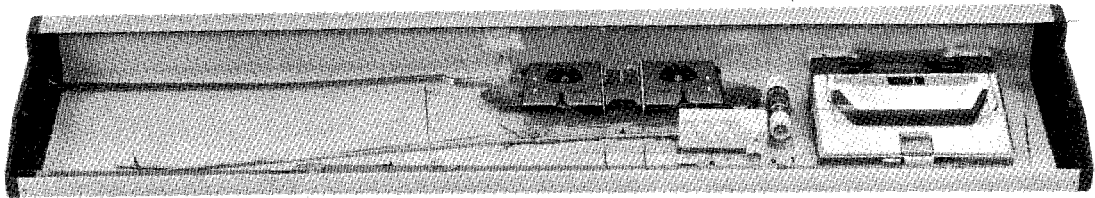

188

(14) Close the carrying case.
(15) Lock the two catches.

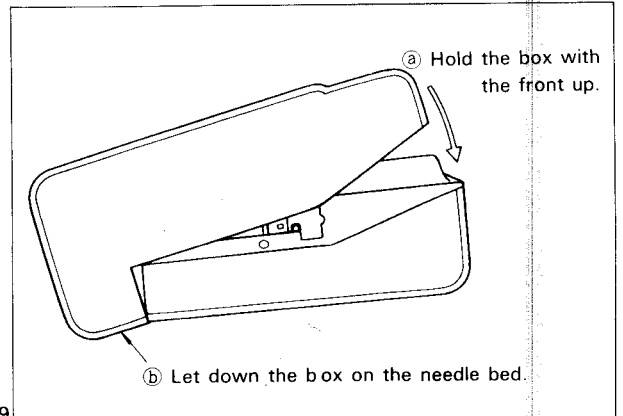

189

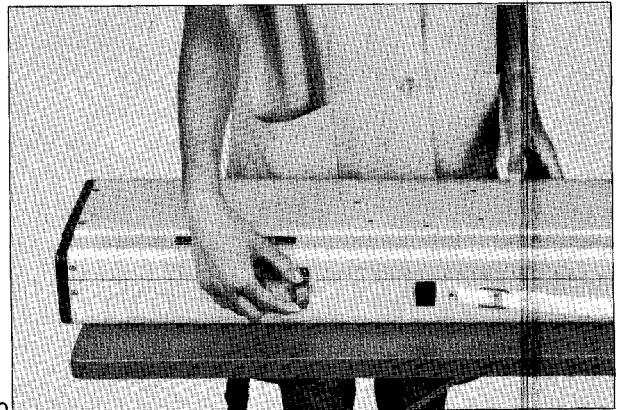

190

Useful Attachments for your knitter!

70

Ribbing Attachment
Model No. KR-810

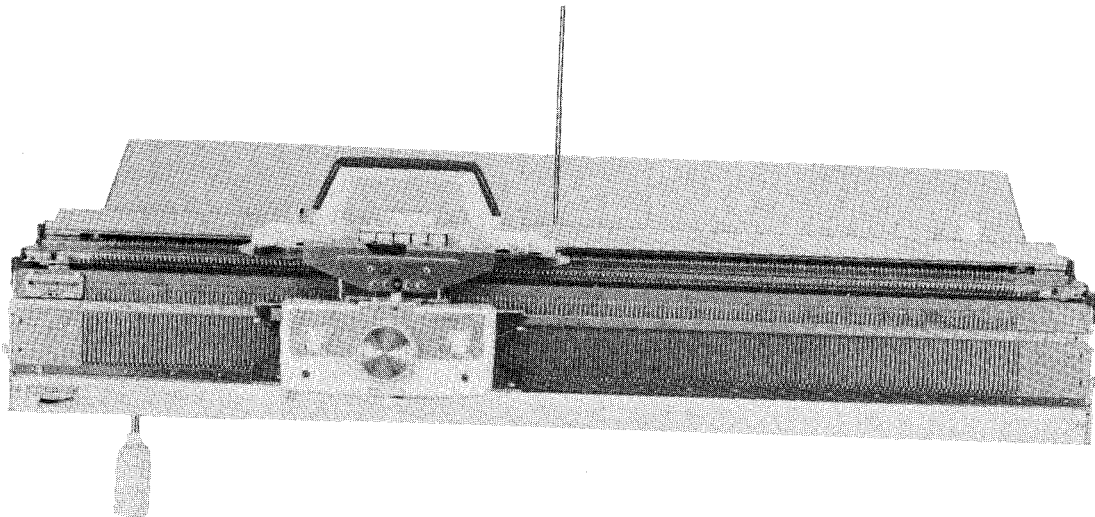

191

Speedily and automatically knits beautiful rib design combinations and circular knitting. Knit rib cables, zigzag ribs, braided patterns, basket weave herring-bone effects, plus numerous others never ever seen on ready-made knitwear. Special patterns for evening stoles, embossed ripple stitch for cuffs, hems or borders. Knit four different types of permanent pleats. (Complete with Instruction Book.)

Knit-Leader
Model No. KL-115

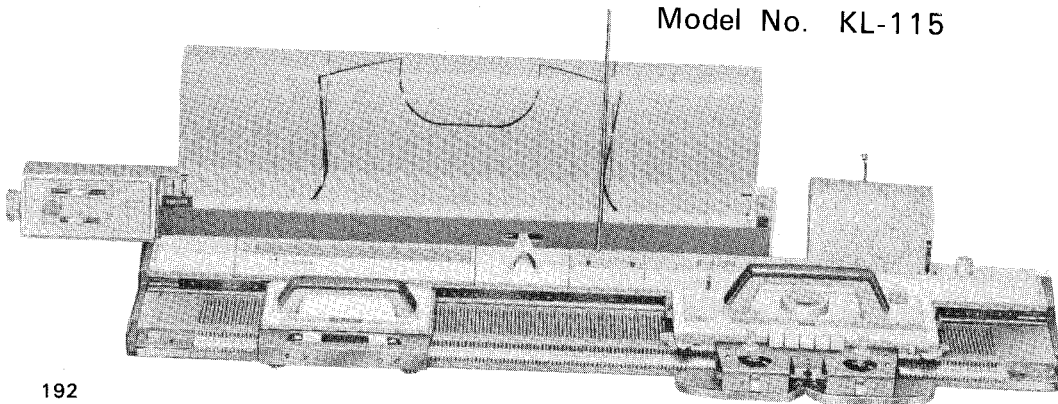

192

A knit-to-shape guidance system. You simply trace any paper pattern onto the transparent screen and start knitting. You see at a glance when to add on or take off stitches. You no longer have to measure or count the rows. It's all done for you.

