

HOW TO USE YOUR MACHINE

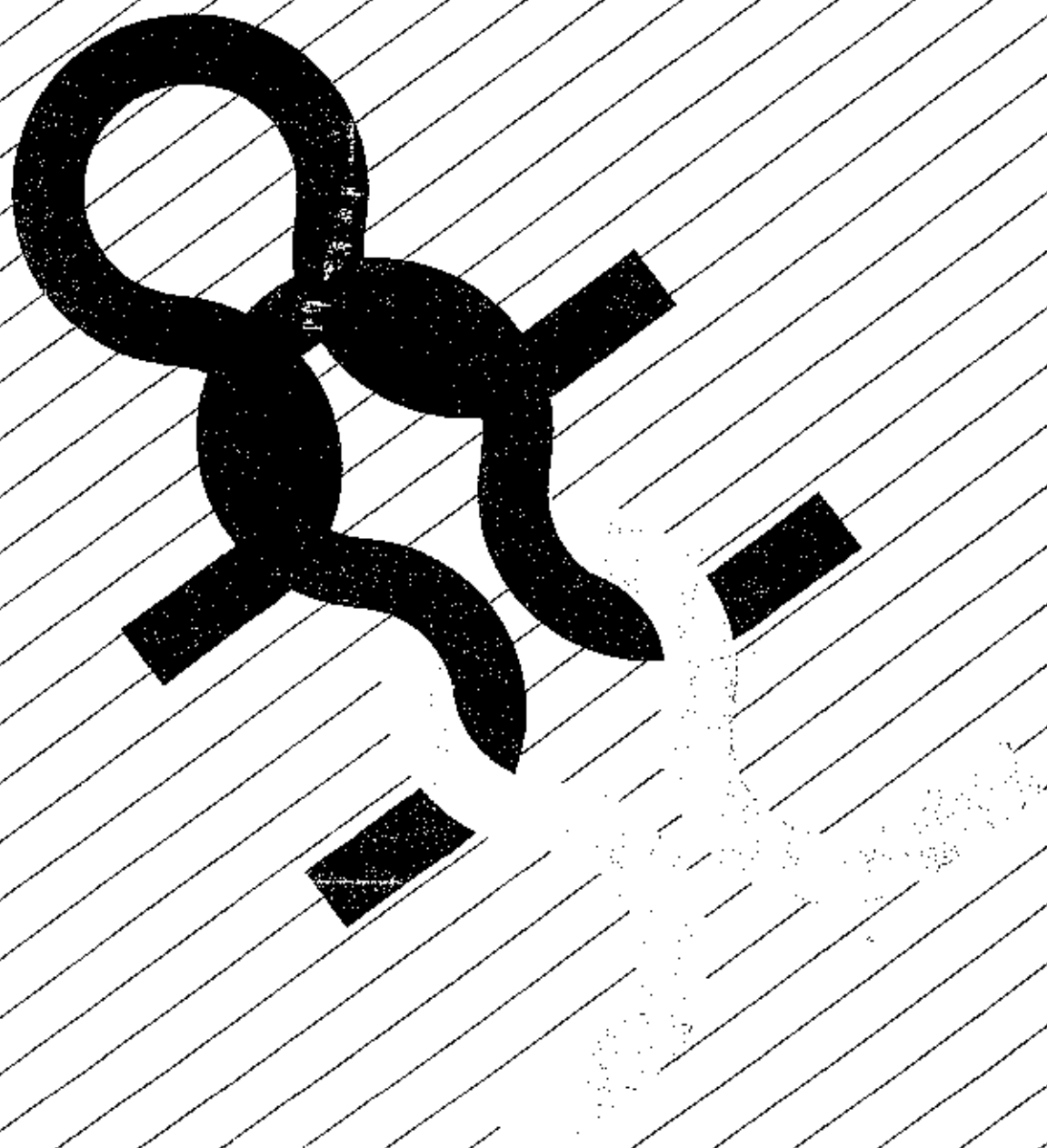

KX 350



① LADY'S SWEATER
(Page 14)

② LADY'S SWEATER
(Page 23)

HOW TO USE YOUR MACHINE

1. SETTING UP YOUR MACHINE	2
2. MACHINE	3
Needle	
3. ACCESSORIES	3
4. BEFORE KNITTING	4
RELEASING AND SETTING THE CARRIAGE	4
NEEDLE POSITIONS	4
TENSION DIAL	5
PART LEVERS AND HOLDING CAM LEVERS	5
PREPARING THE YARN	6
CAST-ON COMB	6
5. START TO KNIT (Tension Swatch)	7
1 LADY'S SWEATER	14
2 LADY'S SWEATER	23
3 LADY'S CARDIGAN	32

PATTERN KNITTING

1. PULL-UP STITCH PATTERN (TUCK STITCH PATTERN)	40
2. SKIP STITCH PATTERN	40
3. MULTI-COLOUR SKIP STITCH PATTERN	41
4. LACE PATTERN	42
5. KNIT & PURL STITCH PATTERN	42
6. CABLE STITCH PATTERN	44

BASIC TECHNIQUES FOR MAKING GARMENTS

1. HOW TO USE THE TRANSFER TOOL	45
2. HOW TO USE THE LATCHET TOOL	46
3. DECREASING STITCHES	47
4. INCREASING STITCHES	48
5. PARTIAL KNITTING	49
6. WASTE KNITTING	51
7. BACK STITCH	51
8. REMOVING THE WASTE KNITTING	51
9. CASTING-OFF	52
10. BINDING OFF FOR FINISHED EDGE	53
11. PICKING UP THE STITCHES	54
12. PICKING UP THE SIDE EDGE STITCHES	54
13. BINDING OFF ON THE MACHINE TO JOIN THE KNITTING	54
14. SEAMING	55
15. FINISHING	55

USEFUL HINTS (PROBLEMS DURING KNITTING)

1. WHAT TO DO WHEN YOU CANNOT KNIT SMOOTHLY	56
2. HOW TO PICK UP A DROPPED STITCH	56
3. WHAT TO DO IF YOU MAKE MISTAKES AS YOU KNIT	57
■ IF THE CARRIAGE SHOULD JAM	57
■ IF YOU WANT TO UNRAVEL SOME KNITTING	59

LOOKING AFTER YOUR MACHINE

1. REPLACING A NEEDLE	60
2. CLEANING AND MAINTENANCE	60

* HOW TO REPLACE YOUR MACHINE

HOW TO USE YOUR MACHINE

1 SETTING UP YOUR MACHINE

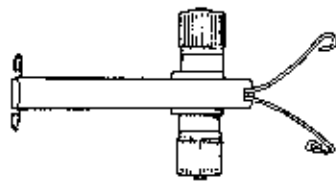

Tension



Row Counter



Tension Rod

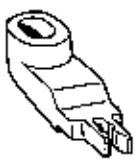

Tension Rod Stand

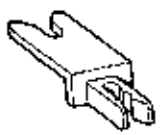

Yarn Rest

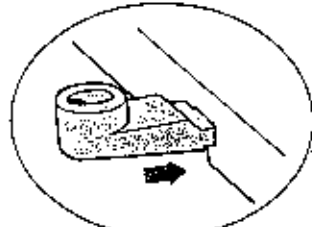
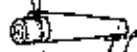

Insert the Tension Rod Stand into the centre hole.

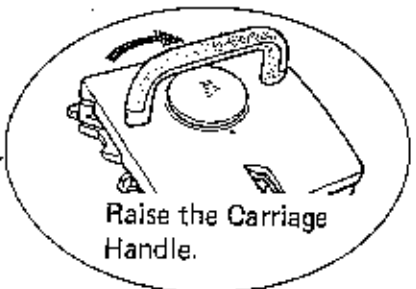

Raise the Carriage Handle.

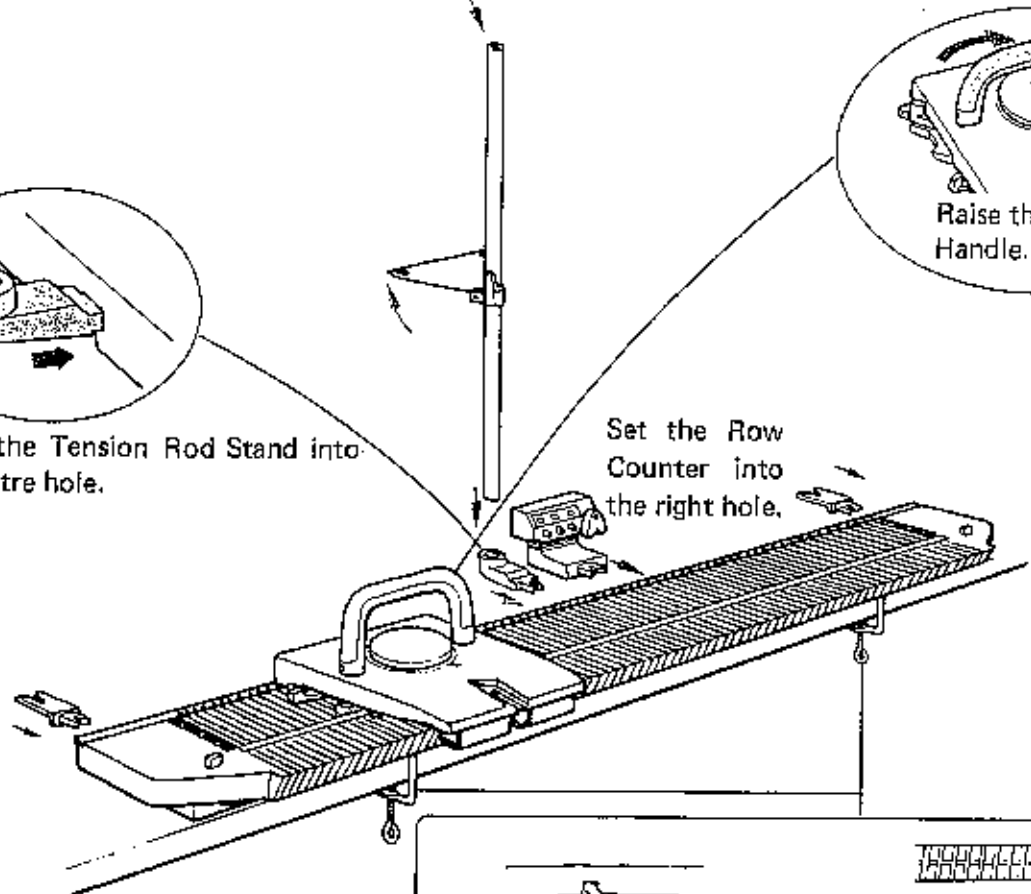

Set the Row Counter into the right hole.

Pull out the Table Clamp and turn it until becomes vertical.
* You can replace the Table Clamp in the reverse way.

Fasten the Table Clamps.

2 MACHINE

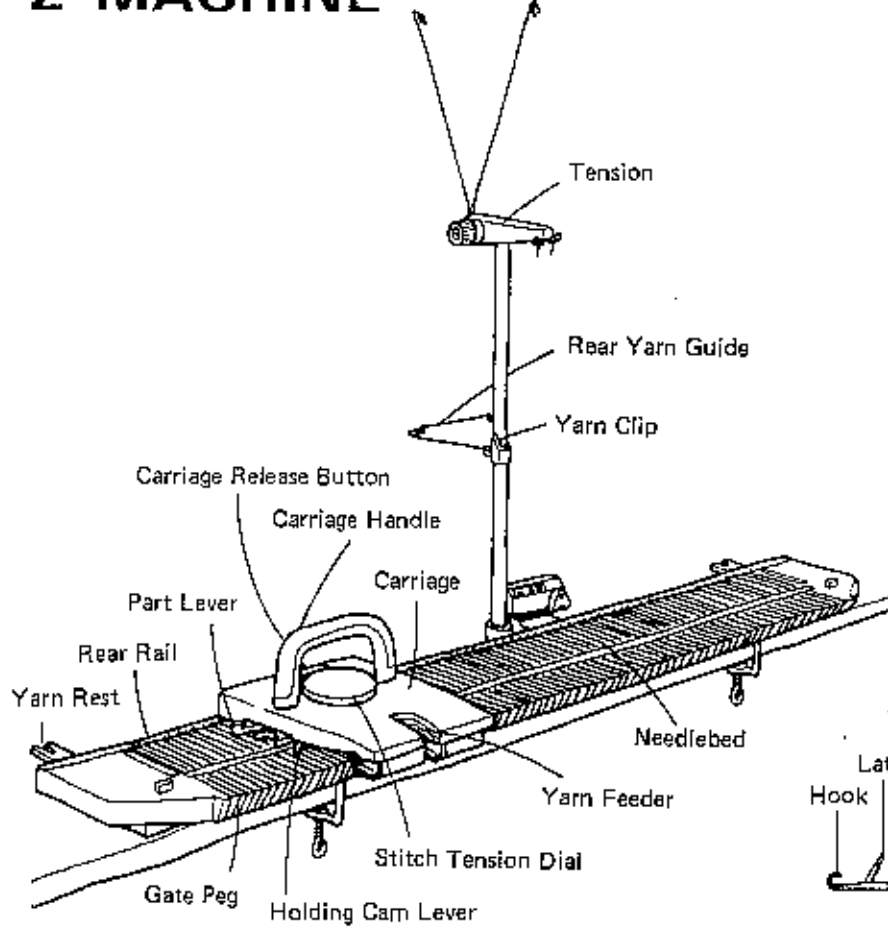

NEEDLE

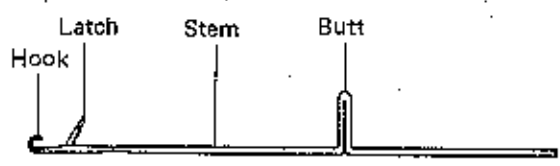

3 ACCESSORIES



Cast-on Comb

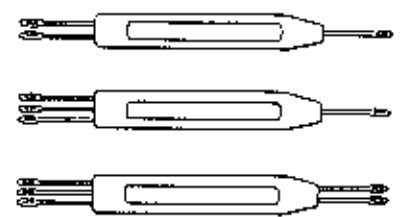

Transfer Tools

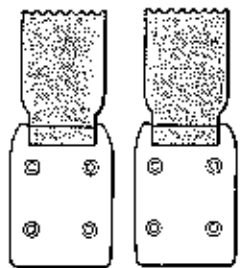

Claw Weights

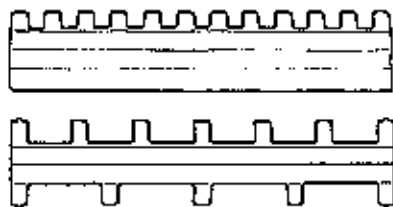

Needle Pusher

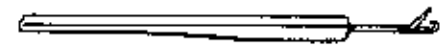

Latchet Tool



Tapestry Needle

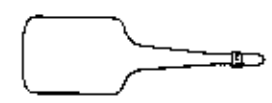

Silicone Oil

4 BEFORE KNITTING RELEASING AND SETTING THE CARRIAGE

RELEASING

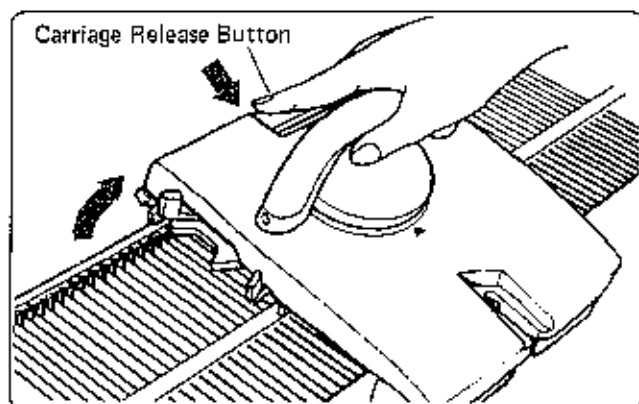

Push the Carriage Release Button and lift the Carriage up towards you.

SETTING

Method 1

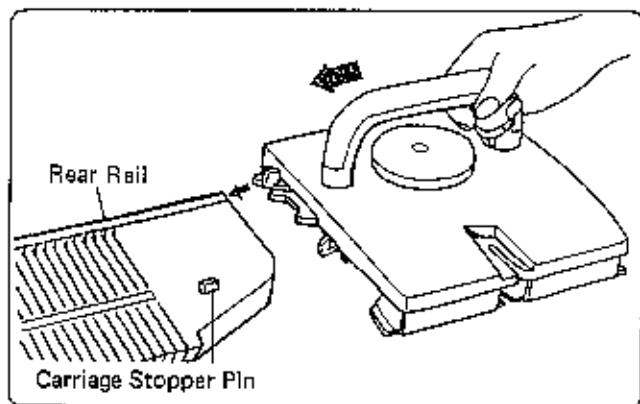

Slide the Carriage onto the needlebed. Ensure that the Rear Foot has engaged the Rear Rail. When the Carriage stops against the Carriage Stopper Pin, raise the front part a little to clear the Stopper Pin.

Method 2

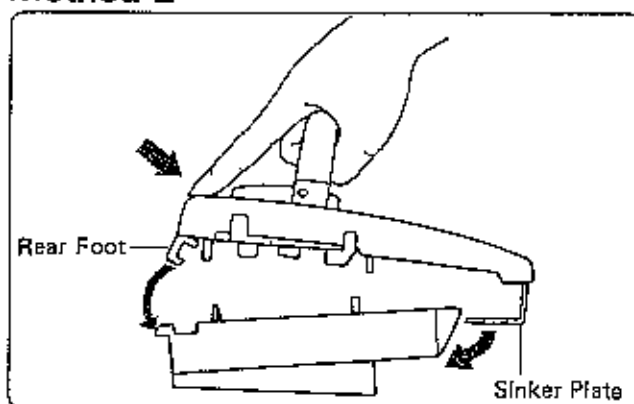

Ensure needles are in A position. Push the Carriage Release Button and hook the Sinker Plate onto the Gate Peg, then fix the Rear foot onto the Rear Rail.

NEEDLE POSITIONS

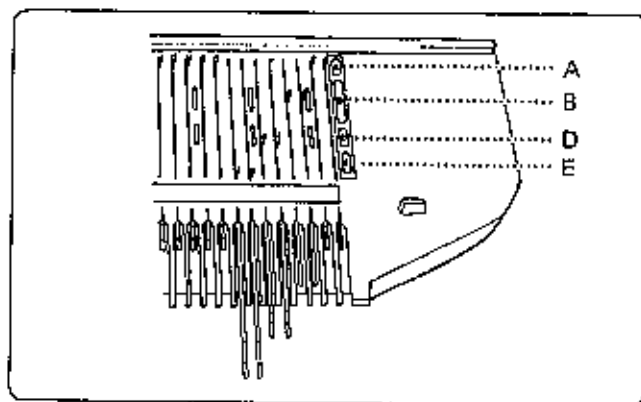

A position ... Non-working position. Even if you operate the Carriage, the needles do not work.

B position ... Working position. Used for general knitting purposes.

D position ... Upper working position. You select the needles to this position in pattern knitting such as skip stitch.

E position ... Holding position. Used for shaping e. g. necklines, shoulders darts and pull-up (tuck) stitch patterning.

* When you set the needles to B or D position, refer to the flutes on the needlebed.

TENSION DIAL

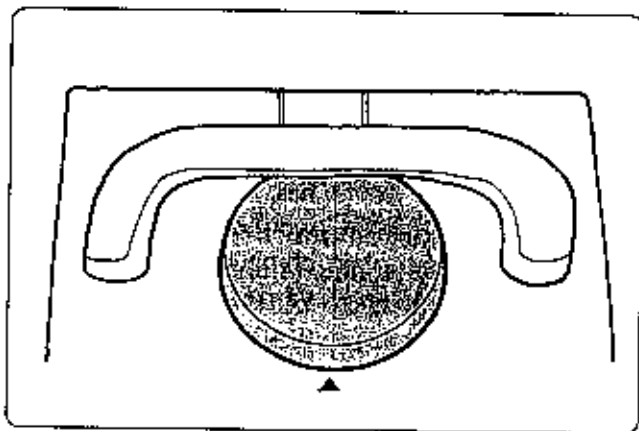

This dial is graduated from 0 to 10. With this dial you can alter the size and tension of your stitches. 0 is the tight tension (i. e. the smallest stitch) and 10 is the loosest tension (i. e. the largest stitch). You should adjust the dial to a higher or lower number according to the thickness and type of yarn you are using.

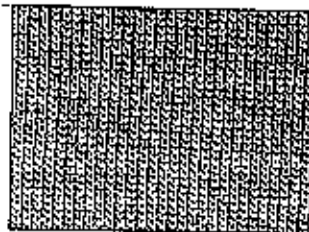

Lower tension knitting



Higher tension knitting

Weight of yarn	Recommended Tension Dial Setting
380 m/100 g	1–3
220 m/100 g	4–6
160 m/100 g	7–9

As there are so many different types of yarn, it is impossible for us to tell you which Tension Dial Setting you should use. You must decide for yourself which is correct for your yarn by working sample swatches. Use the information above as a rough guide only.

PART LEVERS AND HOLDING CAM LEVERS

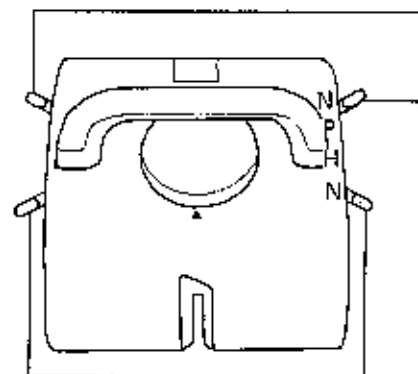

Part Lever

N For normal knitting. When the Part Lever is set at N, needles at B, D, and E positions are knit.

P For skip stitch pattern and multi colour skip stitch pattern. When the Part Lever is set at P, needles at D and E positions are knit.

Holding Cam Lever

N For normal knitting. When the Holding Cam Lever is set at N, needles at B, D, and E positions are knit.

H To knit neck line, or for partial knitting and pull-up stitch pattern. When the Holding Cam Lever is set at H, needles at B and D positions are knit.

The right Lever works when the Carriage moves rightward.
The left Lever works when the Carriage moves leftward.

PREPARING THE YARN

When you are new to machine knitting, you are advised to start with new yarn which is smooth and of reasonably good quality.

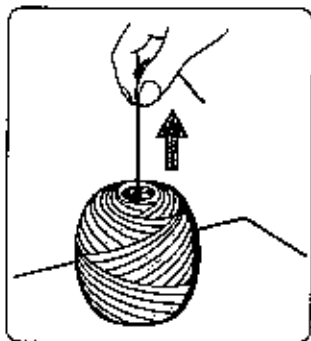

Pull the yarn from the center of a ball.

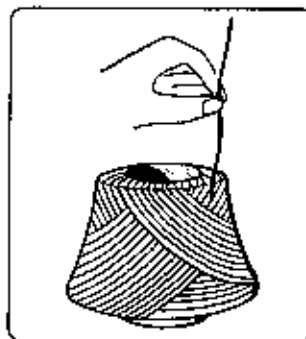

Coned yarn is available from some shops, this has been specially wound ready for machine knitting. Use the yarn from the outside of the cone.

You had better rewind the yarn using the wool winder, if you can get it.

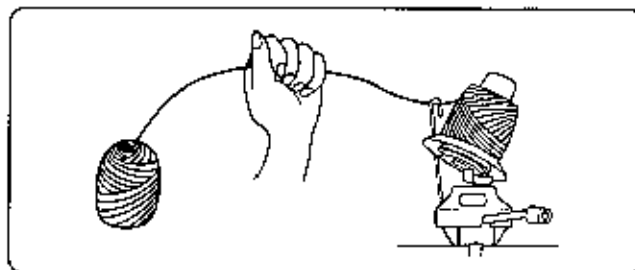

CAST-ON COMB

If you are using more than 65 needles you will need both pieces of the Cast-on Comb, push them together as illustrated.

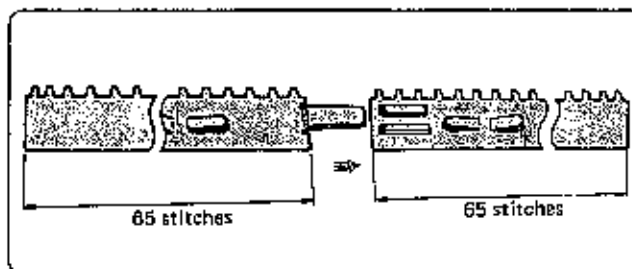

3 START TO KNIT (Tension Switch)

We will knit the tension switch as a practice. The tension switch is the basis for calculating the number of stitches and rows required. The switch is a sample piece knitted in exactly the same way as the finished garment will be knitted. This example shows the tension switch for 1 LADY'S SWEATER (page 14) (stocking stitch).

Please prepare two yarns.

Main yarn: yarn to knit the garment

Waste yarn: different coloured yarn, you can use end of ball pieces for this, in a similar weight.

1 Thread the yarn in the order as shown

- ① Making sure the yarn is free flowing. Pass it through the Rear Yarn Guide sliding through the eyelet.
- ② Hold the yarn as shown and pull it down so that the yarn goes under the Tension Pin.
- ③ Lay the yarn over the Yarn Guide Hook and slide into Loop.
- ④ Holding the yarn in one hand, pull the Take-up Spring down and hook the yarn into the Loop.
- ⑤ Clip the yarn under the Yarn Clip until it is needed for knitting.
- ⑥ Set the arrow mark according to the thickness of yarn.
 - ▶ +380 m/100 g (Weight of yarn)
 - ▶ ◀ 220 m /100 g
 - ▶ - 160 m/100 g

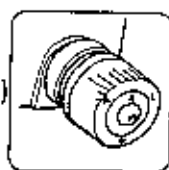

Thread the waste yarn into the left-hand Tension Unit in the same way.

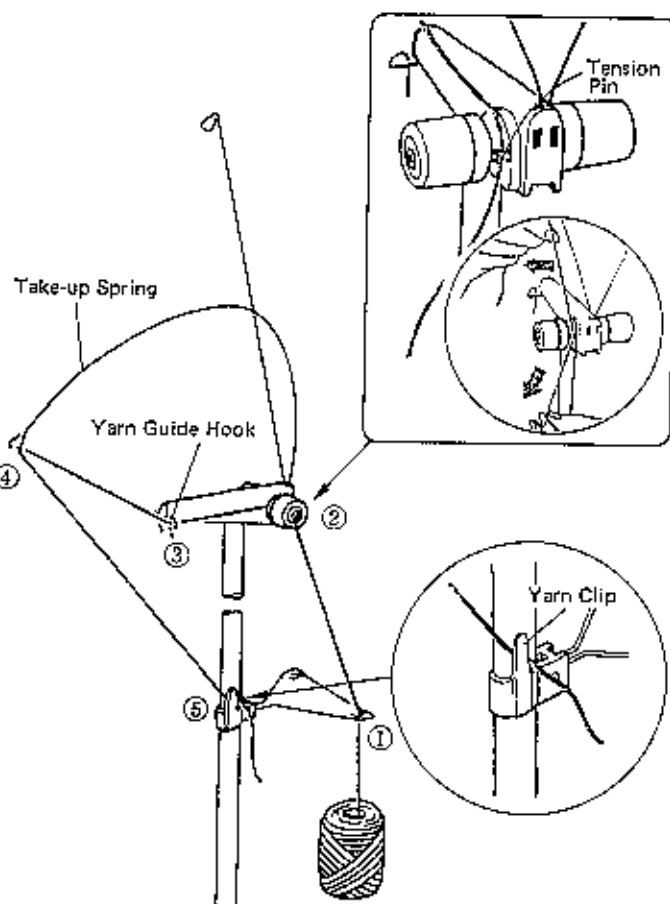

2 Arrange the needles

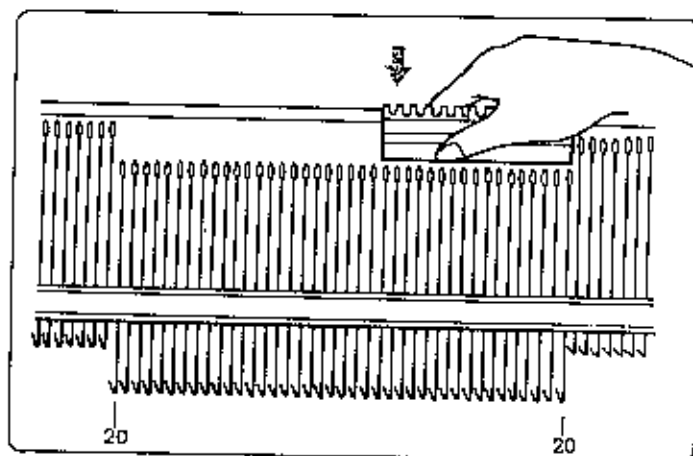

Push the required needles to B position with the flat side of the Needle Pusher, 20 needles each side of the centre – 40 needles in all – are needed for this tension switch.

3 Pull the Carriage across the needle bed:-

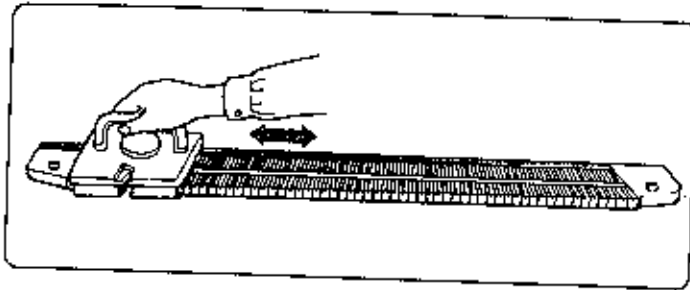

Move the Carriage across the needlebed a few times to align the needles, ending with the Carriage on the left. Make sure the Carriage clears the end needle before you move it back in the other direction.

4 Take every other needle back to A position

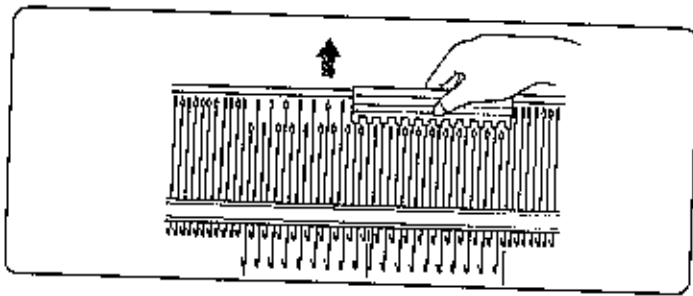

5 Set the Carriage:-

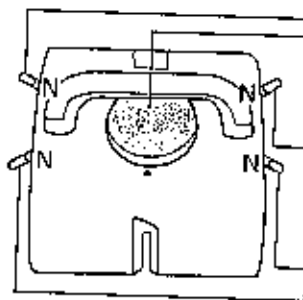

Set the Tension Dial according to the thickness of the yarn. *Refer to p. 5. *(In this example, 6)

Part Lever ... N (normal knitting), the Part Levers on each side of the Carriage towards the back.

Holding Cam Lever ... N (normal knitting), the Holding Cam Levers on each side of the Carriage towards you.

6 Set the Row Counter to 000 by turning the dials in the direction shown on the Row Counter

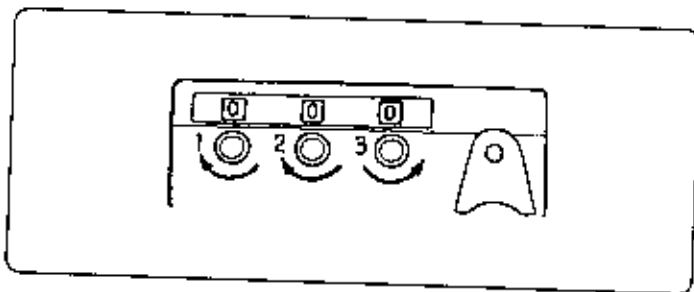

7 Thread the Yarn Feeder:-

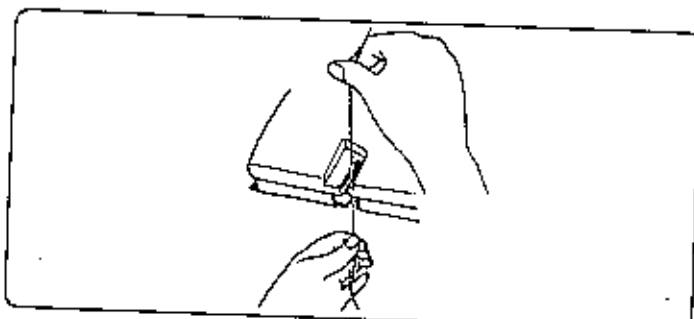

Take the main yarn out of the Yarn Clip, holding it with one hand about 30cm from the end and the other hand 10cm from the yarn end, push it to the back of the Yarn Feeder as shown.

8 Holding the yarn end gently, slowly pull the Carriage across the needles to the right.

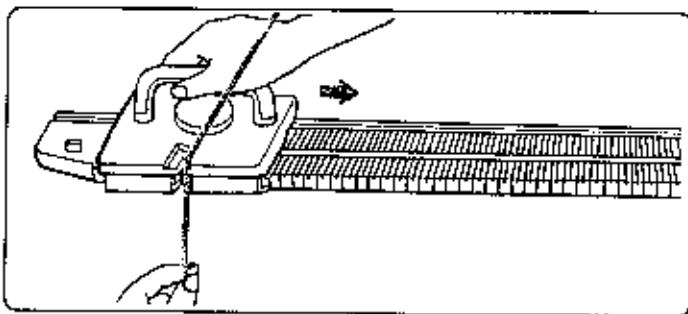

Once you feel the needles catch the yarn, you can release the end of yarn.



The yarn is caught on the needles in B position.

9 Hook the Cast-on Comb over the loops

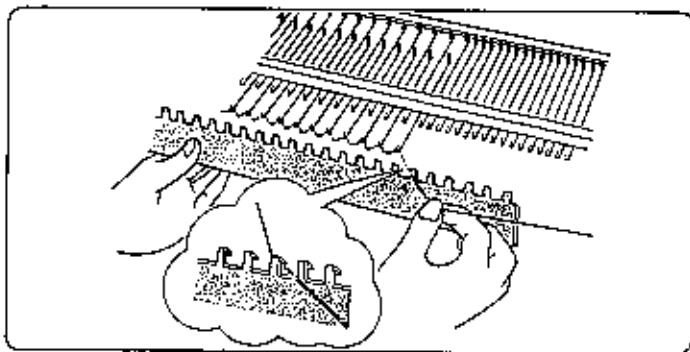

Hold the Cast-on Comb with the hooks facing the machine and hang it over the loops evenly at the same time lift the yarn between the Carriage and needlebed over the Cast-on Comb as illustrated.

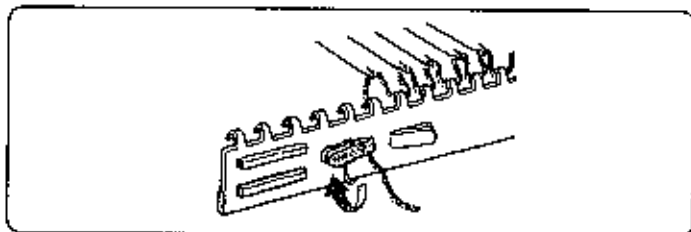

Hook the loose yarn under the Yarn Clip on the Cast-on Comb.

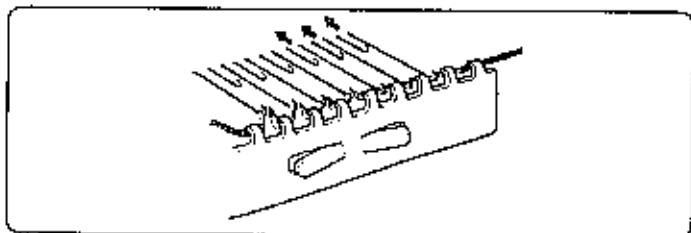

If the needles come out of B position because yarn tension is too tight, push them back to B position.

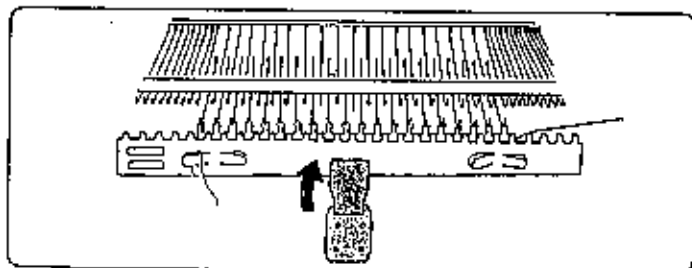

Hang the Claw Weight onto the slit of the Cast-on Comb.

10 Bring forward the empty needles to B position using the flat side of the Needle Pusher

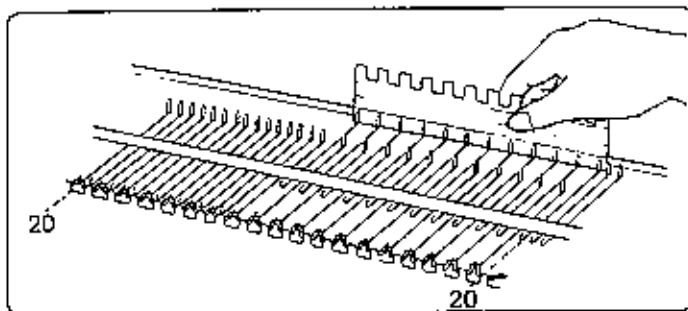

Don't forget to bring forward the end 20th needle to B position.

11 Continue knitting until the Row Counter reads 010

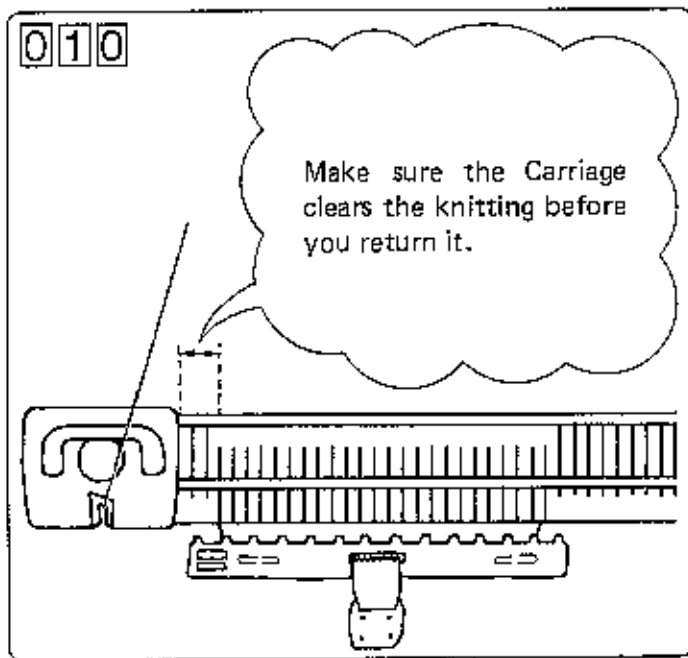

Ensure that you knit at an even speed — this gives an even tension.

12 Knit two rows in waste yarn

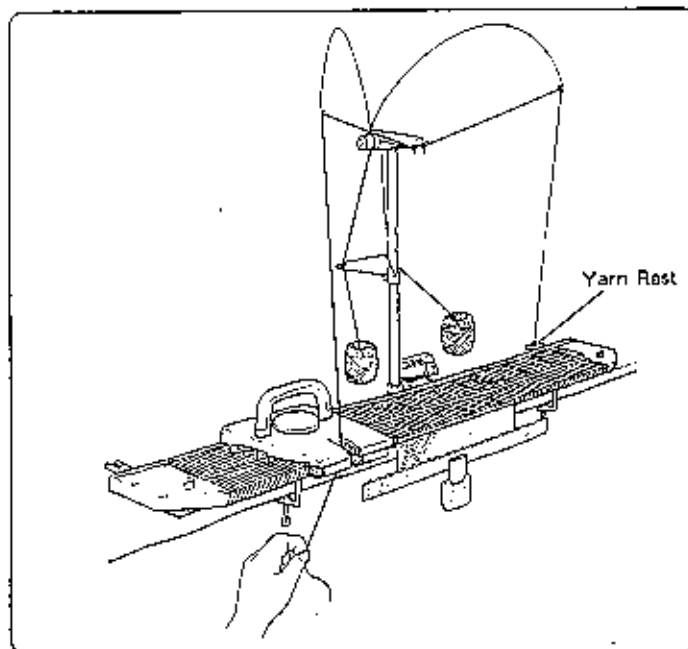

1) Take the yarn out of the Yarn Feeder and hook it onto the Yarn Rest.

*Yarn in right-hand Tension Unit is hooked onto the Yarn Rest at the right-hand side of the machine, and yarn in left-hand Tension Unit is hooked onto the Yarn Rest at the left-hand side of machine.

2) Take the waste yarn out of the Yarn Clip on the Tension Rod and thread the waste yarn into the Yarn Feeder. Knit two rows. Row Counter reads 012. Cut the waste yarn and place into the Yarn Clip on the Tension Rod.

13 Re-thread the main yarn. To avoid loops at end of work, take up any slack by pulling the main yarn back through Tension Unit. Knit 15 rows. The Row Counter reads 027.

027

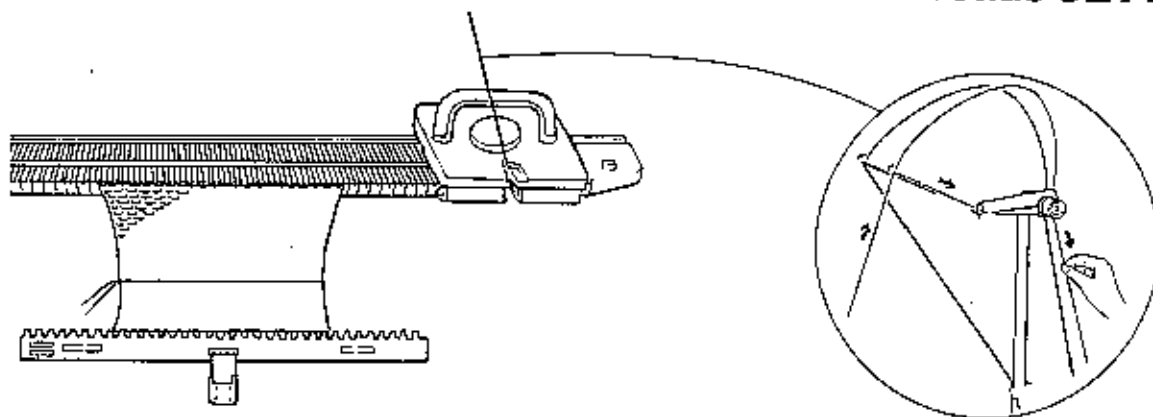

14 Cut two pieces of waste yarn (approx. 10 cm) to use as marker threads and place them onto the needles

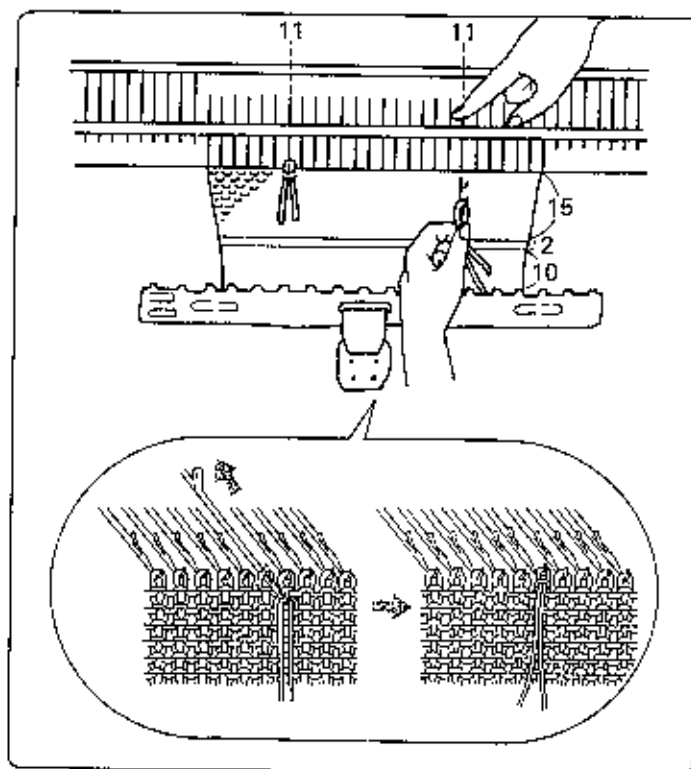

Bring forward 11th needle on each side of centre to E position. Hook a short piece of waste yarn onto the two needles and make a stitch by bringing back the needles to B position.

042

Knit 15 rows in main yarn. The Row Counter reads 042.

15 Knit two rows in waste yarn (Refer to step 12)

044

The Row Counter reads 044.

16 Re-thread the main yarn and knit 10 rows

054

The Row Counter reads 054.

17 Remove the knitting from the machine:-

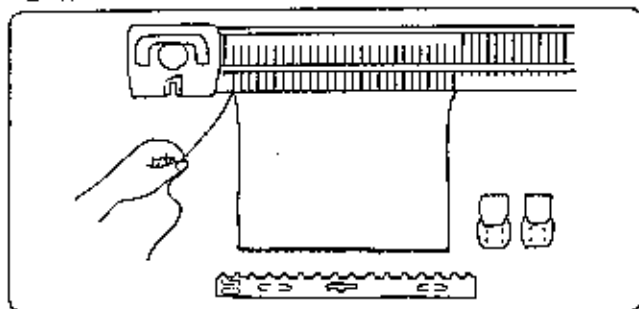

Remove the Claw Weights and the Cast-on Comb. Take the yarn out of the Yarn Feeder and cut it. Put the main yarn into the Yarn Clip on the Tension Rod.

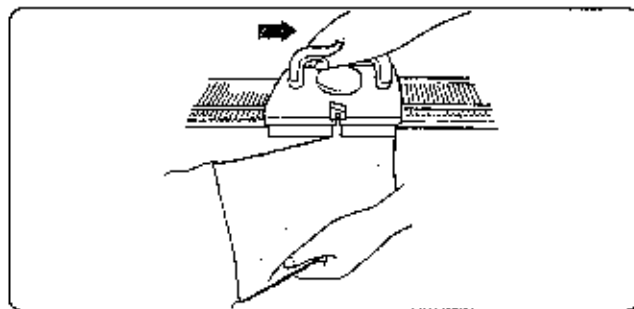

Move the empty Carriage slowly across the needles holding the knitting in one hand to release the knitting.

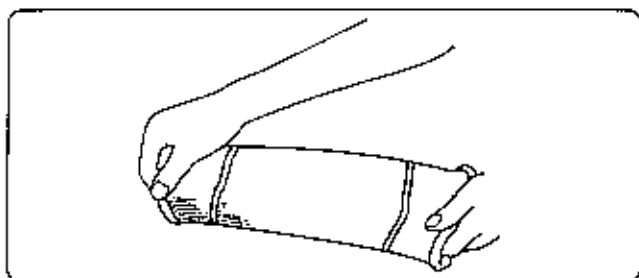

After releasing from the machine the tension swatch is often stretched sideways, pull it lengthwise 2 or 3 times to release stretch.

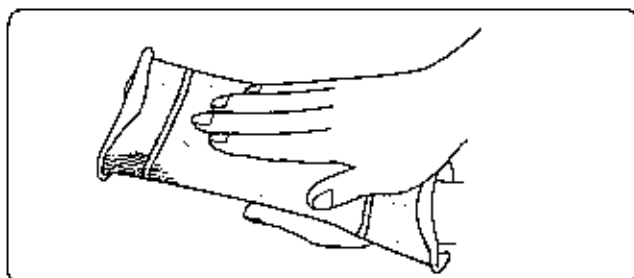

Pat the swatch lightly with your palm to make it even.

18 Press the swatch:-

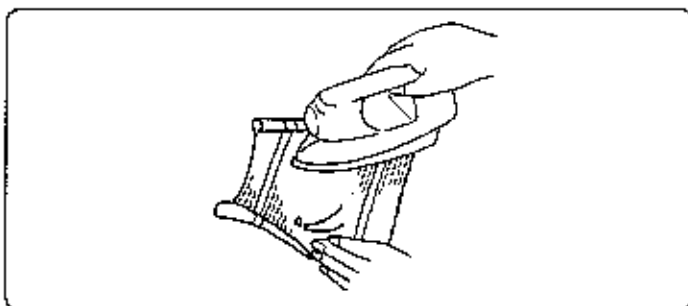

Press the swatch according to the yarn label on a blocking surface.

NOTE:

Never press the iron too hard on the swatch. If the ends are rolling inwards and you find it hard to make it settle, with the wrong side facing, use the pins to hold it in place before you press.

19 Measure the swatch

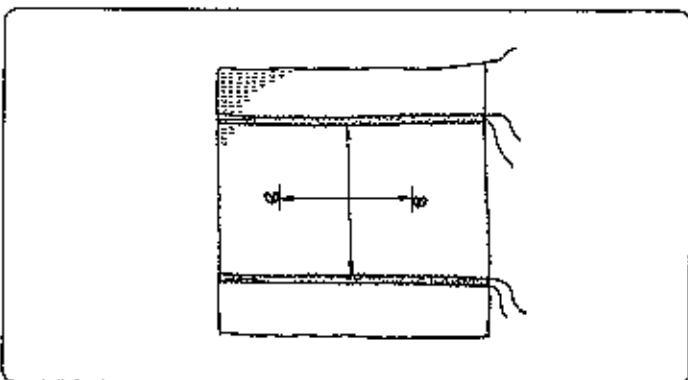

Leave the swatch on flat surface for 2 or 3 hours to give the yarn time to settle.

- 1) Measure the length of 30 rows (between rows knitted in waste yarn)
- 2) Measure the width of 20 stitches (between the 2 waste yarn stitches)
- 3) Calculate and determine the number of the stitches and the number of rows for 10 cm.

EXAMPLE: 20 stitches measures 10.5 cm
30 rows measures 10.7 cm
 $20 \div 10.5 = 1.9$ stitches/cm
 $30 \div 10.7 = 2.8$ rows/cm
 $1.9 \times 10 = 19$ stitches
 $2.8 \times 10 = 28$ rows
19 stitches 28 rows = 10 cm

20 Regulate the tension switch

If you have the same stitches and rows as the tension given for the patterns in this book, you can follow the patterns as they appear. If you have more stitches and rows than the tension given, your work is too tight and you should try again using Tension Dial one point bigger. If you have too few stitches and rows, your work is too loose and you should try again using Tension Dial one point smaller. Tension squares show the measurement of stitches across, and length of rows. If you have to choose between the two, the width tension is the more important. The length can usually be adjusted providing the pattern stitches are not based on a given number of rows which cannot be changed. (i. e. a set number of pattern repeats).

USEFUL NOTES

Ensure that you have enough yarn to complete the row and it does not run out in the middle.

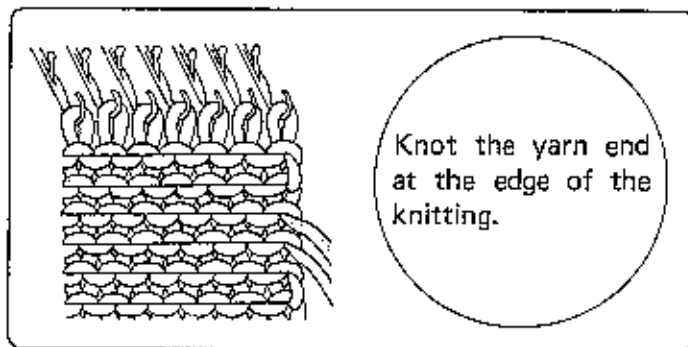

Always start a new ball of yarn at the beginning of a row.

If the Cast-on Comb is not hanging on the knitting or the knitting becomes too long, rehang the Cast-on Comb. If the edge of your knitting is tighter or doesn't knit properly, hang the Claw Weights on both edges of the actual knitting. Rehang the Weights evenly 20 rows or so.

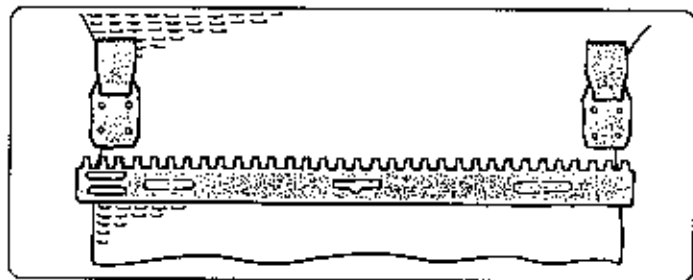

LADY'S SWEATER

SIZE: To fit 96 cm bust

FINISHED MEASUREMENT: 108 cm

MATERIALS: 50% wool 50% viscose
200 metres/100 g ... 750 g

TENSION: stocking stitch
10 cm/19 stitches, 28 rows
(Tension Dial 6)

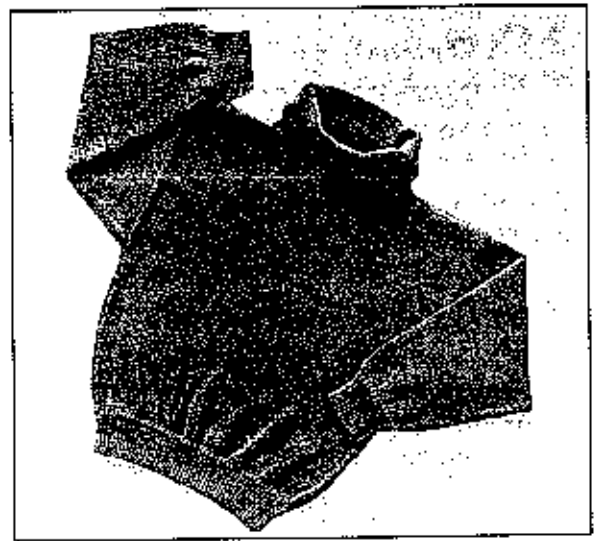
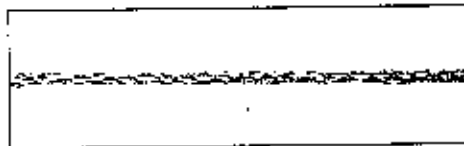

DIAGRAMS

All measurements are given in cms. Figures in brackets show stitches and rows.

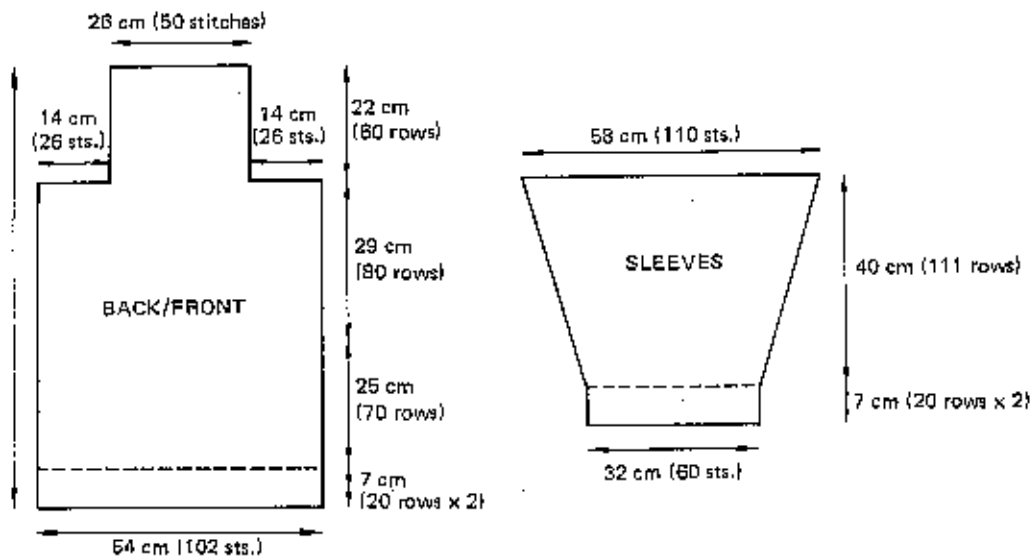

BACK

1

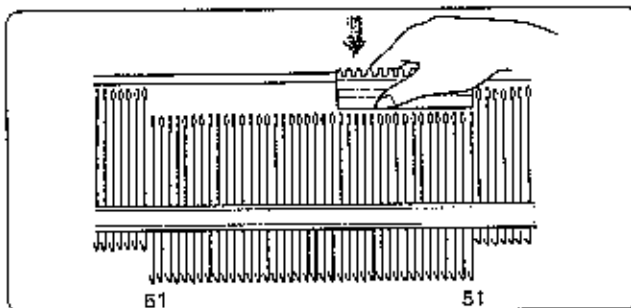

Place the Carriage at the left-hand side of the needlebed. Push 102 needles into B position using the flat side of the Needle Pusher.

2

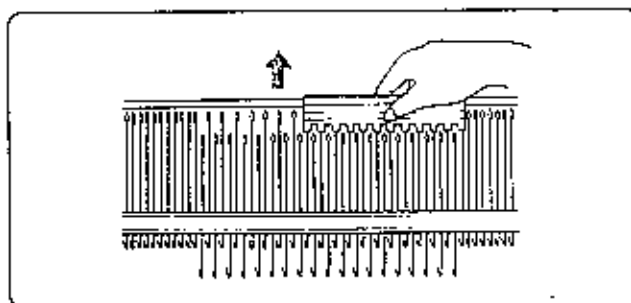

Using the Needle Pusher, push back to A position every other needle. Set the Tension Dial to 2.

3

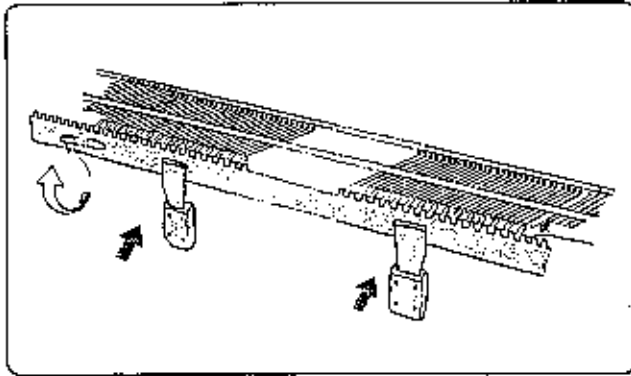

Knit 1 row with the waste yarn.
Hang the Cast-on Comb and the Claw Weights.
Place the end of the yarn under the Yarn Clip.
Push into B position the end needle at right adjacent to needles in B position.

4

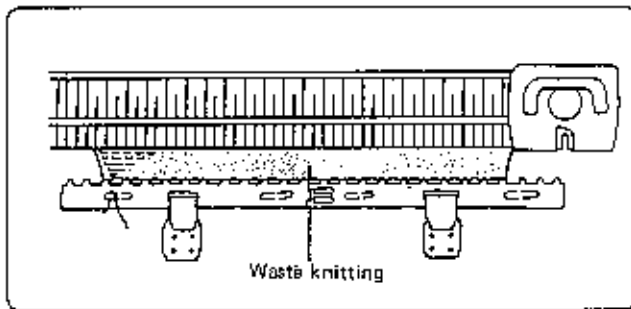

Knit a few rows ending with Carriage at the right.
Cut the waste yarn.

5

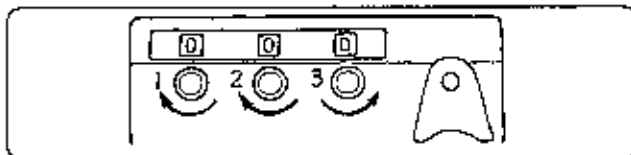

Set Row Counter to 000.

6

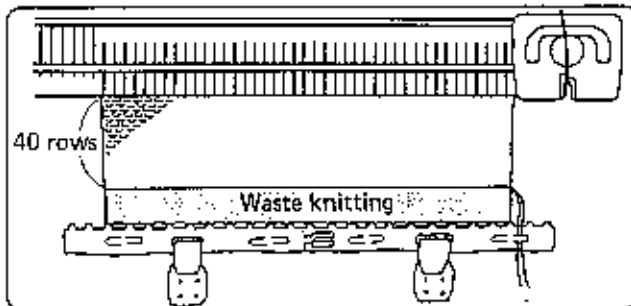

Change to main yarn and knit 40 rows – double length of hem.

7

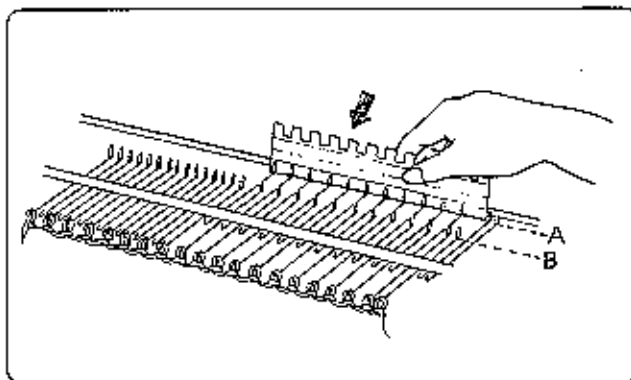

Push into B position empty needles across work.

8

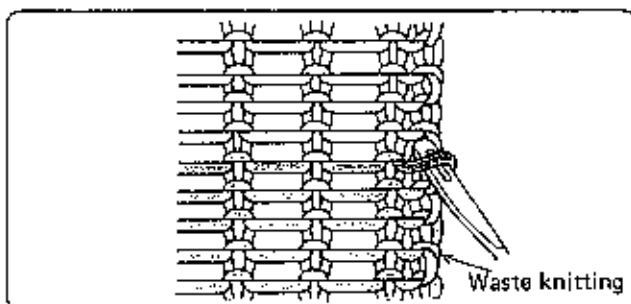

HOW TO MAKE 1 x 1 MOCK RIB

Remove any Weights and the Comb. Using the Transfer Tool, pick up the first stitch of the first row worked in main yarn and place it onto the end needle.

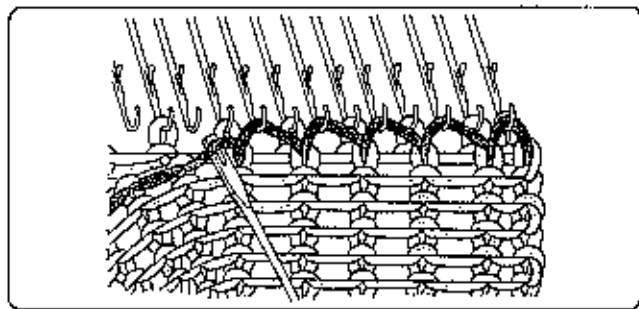

Work across the row in the same manner, placing stitches onto corresponding empty needles.

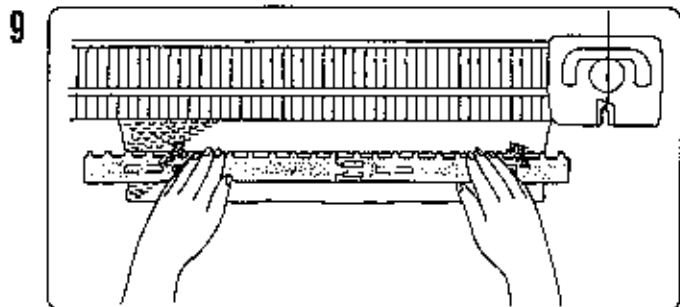

Rehang the Cast-on Comb and the Claw Weights. Ensure that needles are in a straight line across the needlebed.

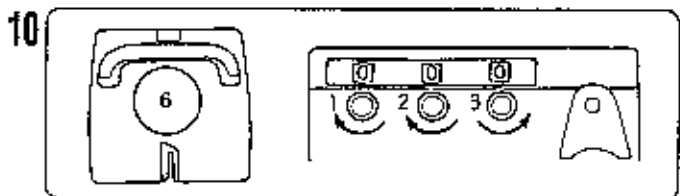

Set the Tension Dial to 6. Set the Row Counter to 000.

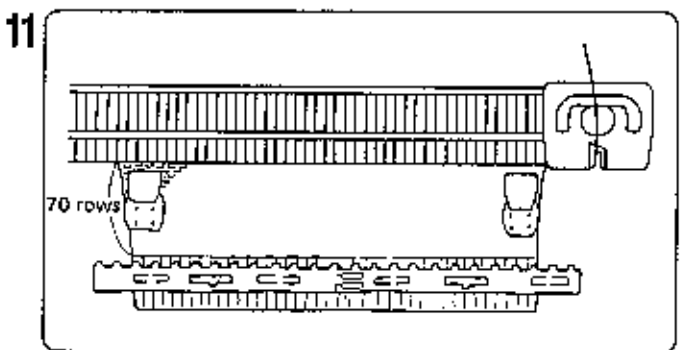

Knit 70 rows to underarm.

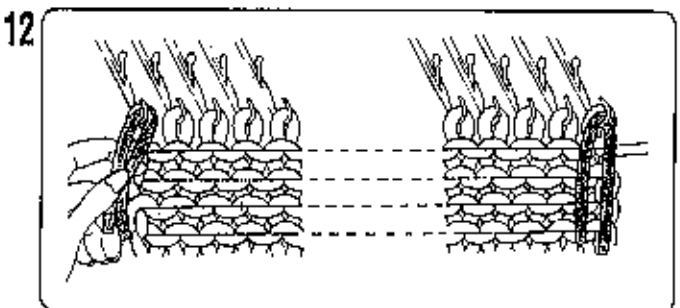

PLACE A WASTE YARN MARKER AT EACH END OF WORK

Push end needles of work into D position. Place a piece of waste yarn into the hook of each end needle. Push them back to B position.

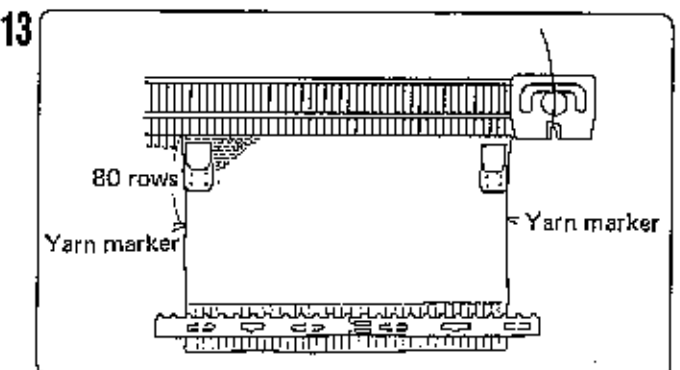

Knit 80 rows to shoulder/neck edge until the Row Counter reads 150.

14

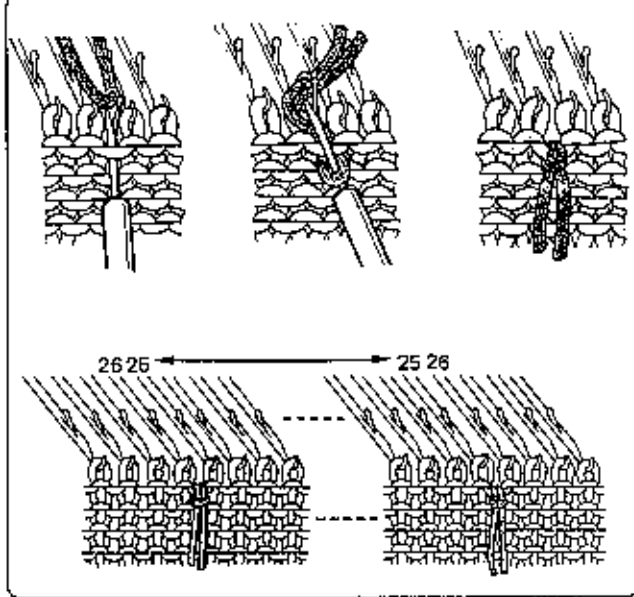

Place a waste yarn marker on sinker loops between 25 and 26 each side of centre to show neck opening. Push the Latchet Tool through the loop of the stitch and place a piece of waste yarn into the hook of the Latchet Tool. Pull the Latchet Tool towards you so that the latch closes catching the waste yarn.

15

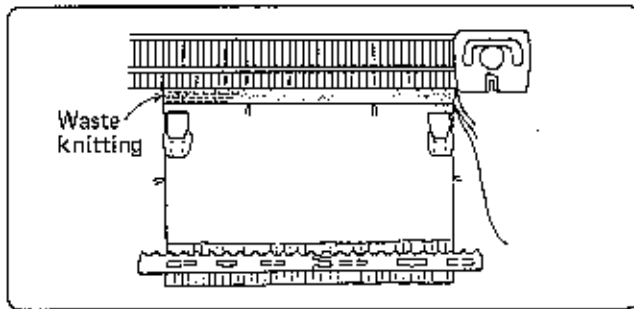

Change to waste yarn and knit a few rows.

16

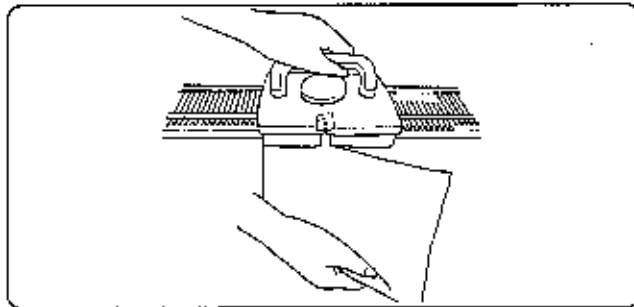

RELEASE GARMENT FROM THE MACHINE

Break the waste yarn and remove it from the Yarn Feeder. Remove any Weights and the Comb. Move the Carriage across the needlebed holding the garment in one hand and it will be released from the machine.

17

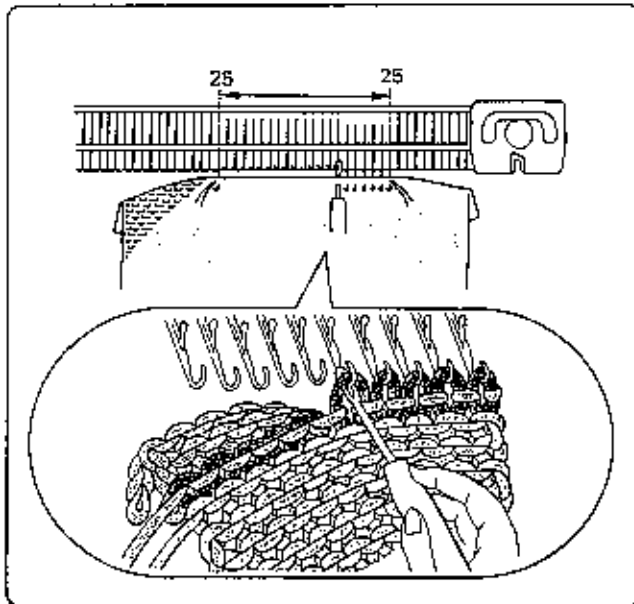

Push back empty needles to A position leaving the centre 50 needles at B position. Place the Carriage at the right-hand side. Replace the stitches between waste yarn markers at neck edge onto these needles wrong side facing you. Rehang the Comb and the Weights.

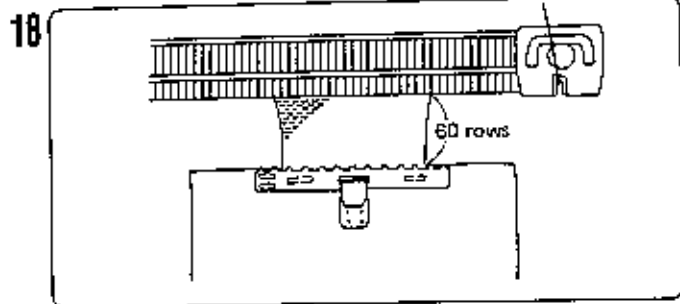

Set the Row Counter to 000. Using the main yarn, knit 60 rows for collar.

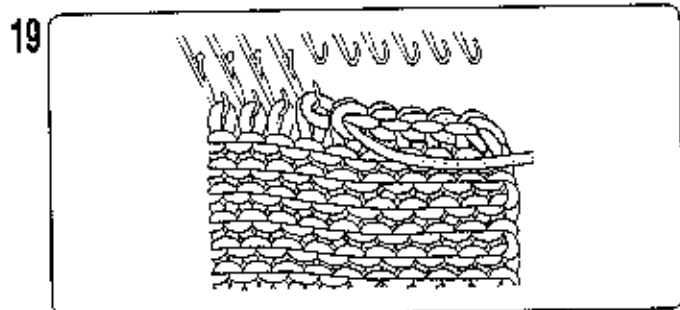

Cast off using a transfer tool. * Refer to p. 52*

FRONT

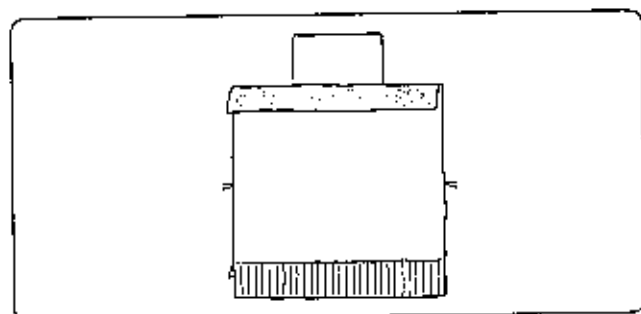

Work in the same way as BACK.

SLEEVES

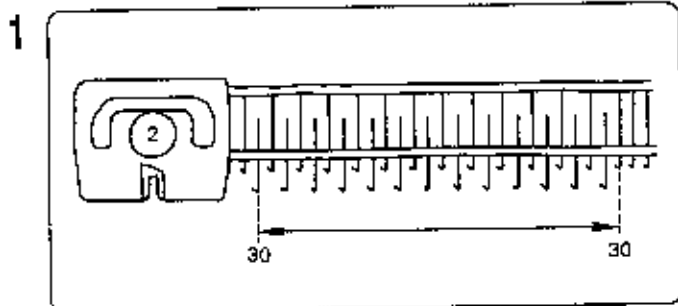

Place the Carriage at the left-hand side of the needlebed. Push 60 needles into B position using the flat side of the Needle Pusher. Using the Needle Pusher, push back to A position every other needle. Set Tension Dial to 2.

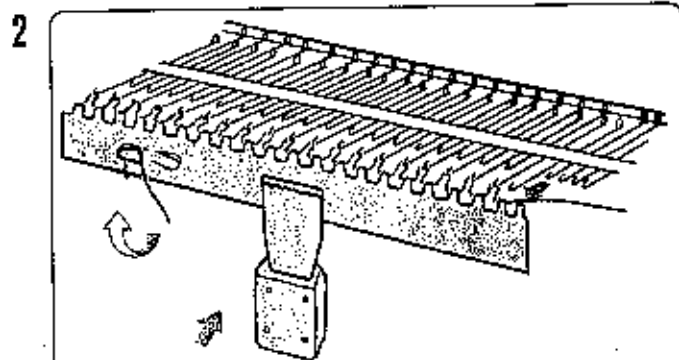

Knit 1 row with waste yarn. Hang the Cast-on Comb and the Claw Weight. Place the end of the yarn under the Yarn Clip. Push into B position the end needle at right adjacent to needles in B position.

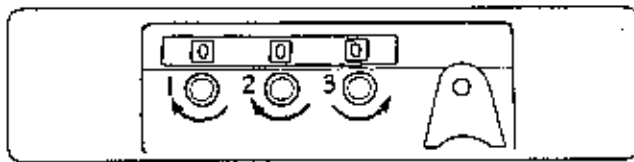
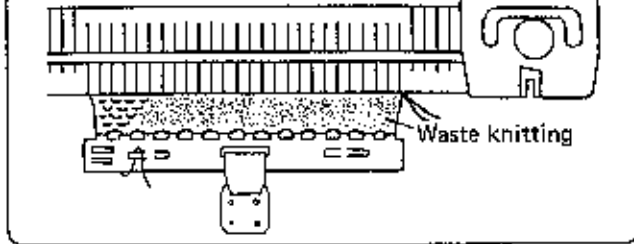

Set Row Counter to 000.

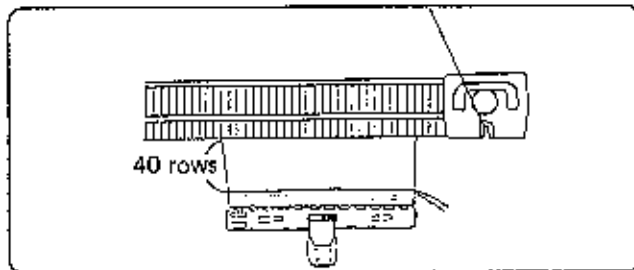

Change to main yarn and knit 40 rows – double length of hem.

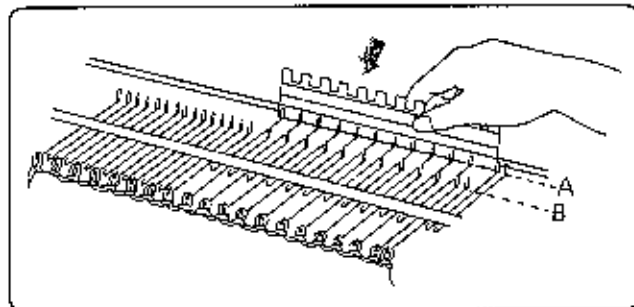

Push into B position empty needles across work.

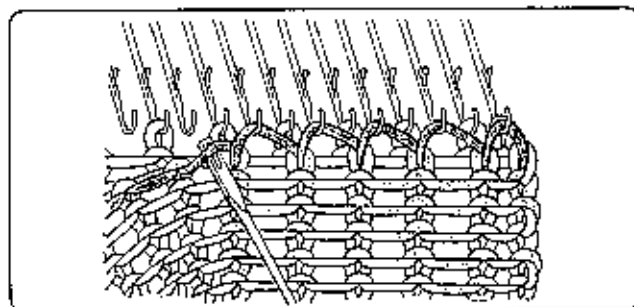

HOW TO MAKE 1 x 1 MOCK RIB

Remove the Weight and Comb. Using the Transfer Tool, pick up the first stitch of the first row worked in main yarn and place it onto the end needle. Work across the row in the same manner, placing stitches onto corresponding empty needles. Rehang the Cast-on Comb and the Claw Weights. Ensure that needles are in a straight line across the needlebed.

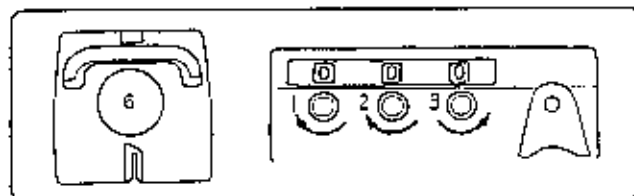

Set the Tension Dial to 6. Set the Row Counter to 000.

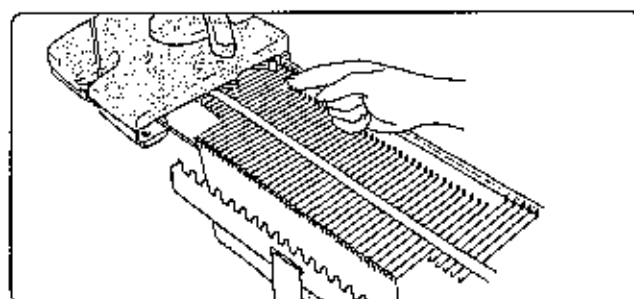

Knit 3 rows, bring forward to B position empty needle adjacent to work at the same side as Carriage. *Refer to Method 1 page 48.*

10

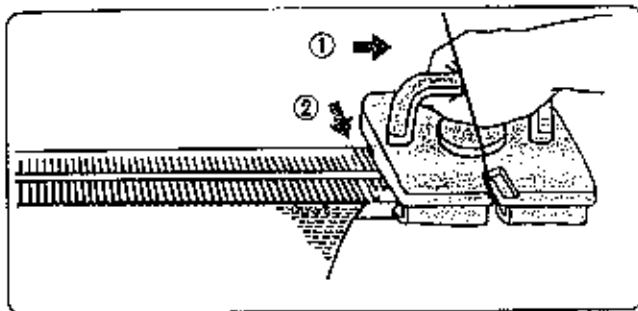

Knit 1 row, bring forward to B position empty needle adjacent to work at the same side as Carriage.

11

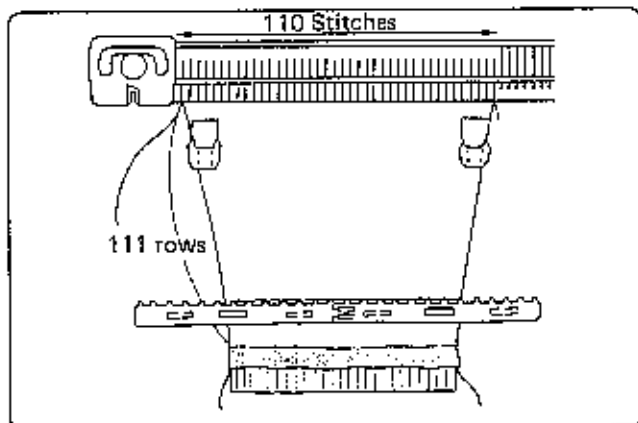

Repeat steps 9 and 10 which is called increasing, until the Row Counter reads 101. There are 110 stitches. Knit more 10 rows without increasing. The Row Counter reads 111. Break the yarn leaving a length of approximately 3 times the knitting width.

12

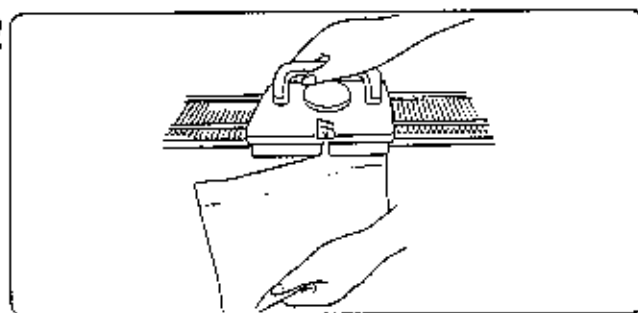

Change to waste yarn, knit a few rows and release the work from the machine.

MAKE-UP

1

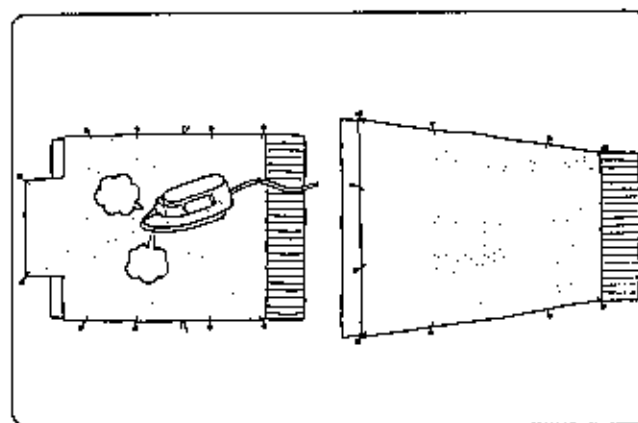

BLOCK AND PRESS

- 1) Remove the waste yarn for 1 x 1 mock rib.
Refer to page 51.
- 2) Place garment pieces, wrong side up on a blocking surface and gently coax into the right shape and size.
- 3) Avoiding the mock rib pin each piece to surface and press.
- 4) Turn over and gently press on the right side.

2-1

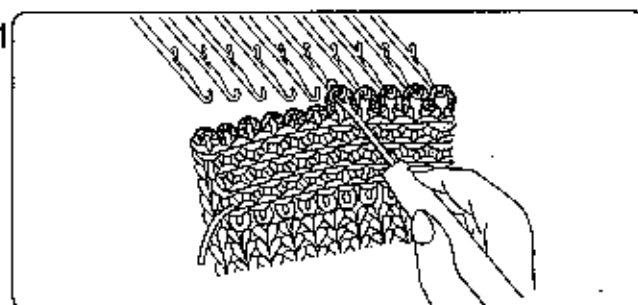

JOIN SHOULDERS

- 1) With the right side of the FRONT facing you, fold the waste knitting towards you, pick up stitches from shoulder and place them onto needles.

2-2

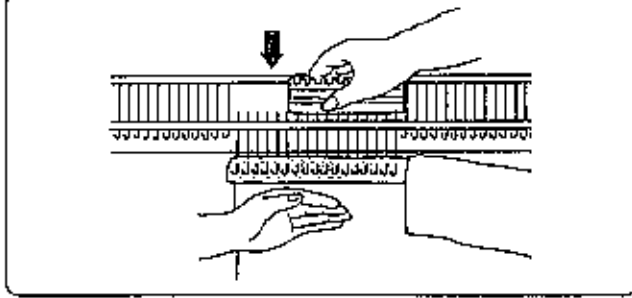

2) Push the needles into E position holding the knitting against the needlebed.

2-3

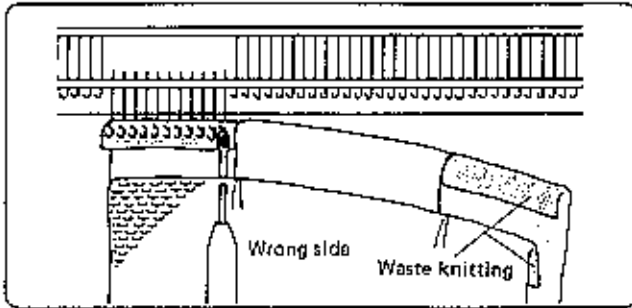

3) With the wrong side of the BACK facing you, fold the waste knitting away from you, pick up the stitches from shoulder and place them into the hooks of the same needles.

2-4

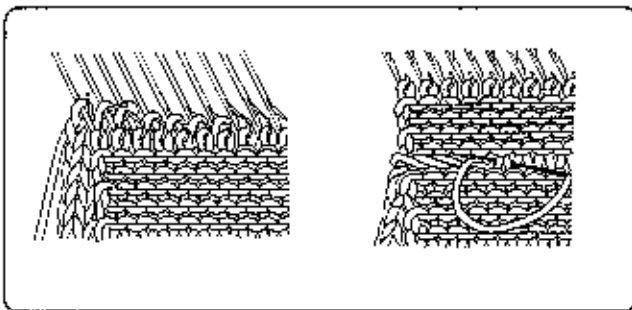

4) Push all the needles back to B position. The stitches in the needle hooks will be pulled through the stitches already on the needles to make a single stitch on each needle.

5) Using a Tapestry Needle bind off all stitches.
* Refer to page 54.*
Remove the waste knitting for shoulder.

3-1

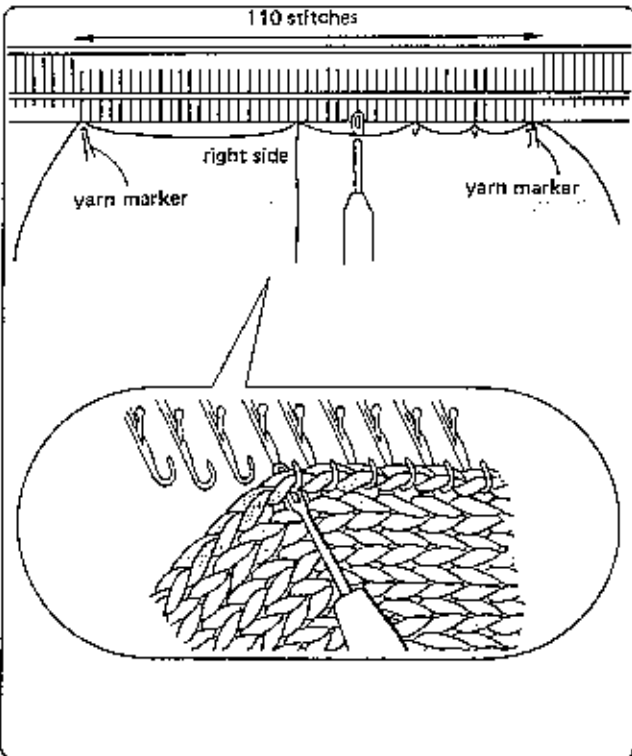

ATTACH SLEEVES TO BODICE

1) Push 110 needles into B position.

With the right side facing you, pick up stitches evenly along armhole edge between waste yarn markers and place them onto needles.

3-2

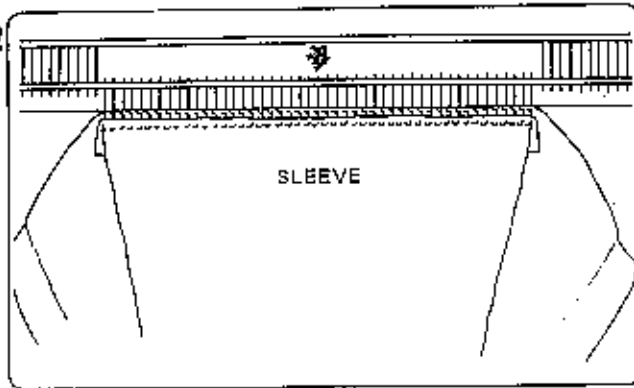

- 2) Push the needles into E position. With the wrong side of the SLEEVE facing you, place stitches from sleeve head into needle hooks. Push the needles back to B position in order to make a single stitch. Using a Tapestry Needle bind off all stitches. *Refer to page 54.*
Remove the waste knitting for sleeve.

4

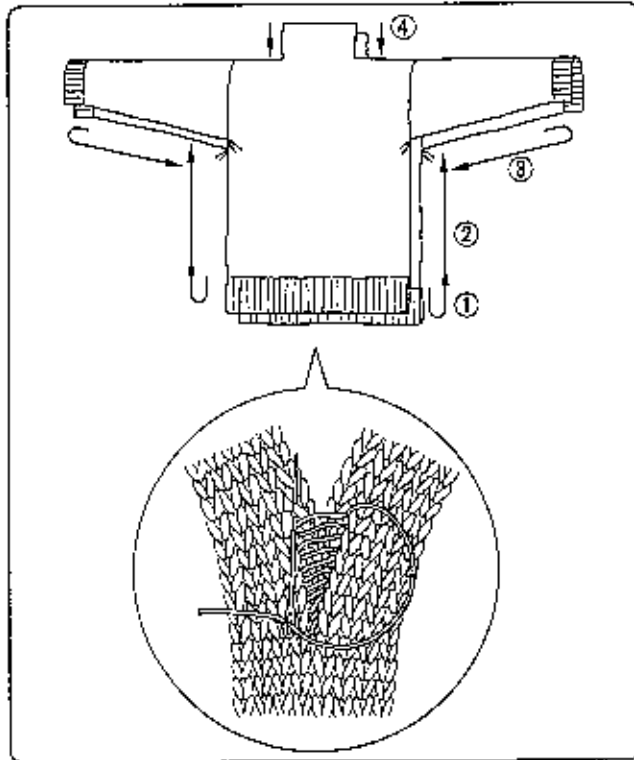

JOIN SEAMS *Refer to page 55.*

- 1) Place two seam edges side by side, wrong side up. Begin at the first row of mock rib. Using mattress stitch close cuff seam, first on the inside and then on the outside.
- 2) Mattress stitch to underarm.
- 3) Mattress stitch SLEEVE seams.
- 4) Mattress stitch COLLAR seams from the wrong side.

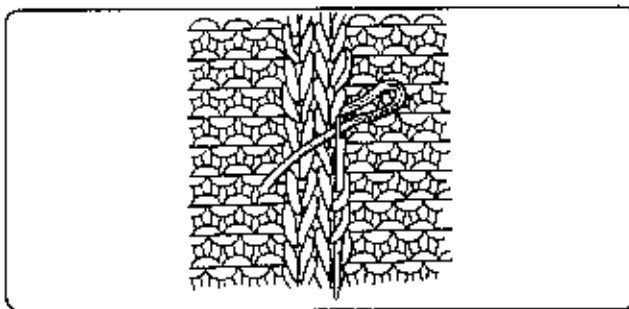

- 5) Sew in yarn ends. *Refer to page 55.*

5

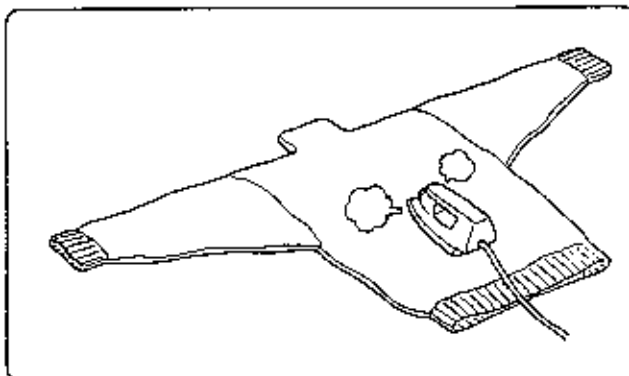

- Press lightly from the wrong side. Turn work over to the right side and give a light press.

2

LADY'S SWEATER

SIZE: To fit 96 cm bust

FINISHED MEASUREMENT: 108 cm

MATERIALS: 75% viscose 15% cotton 10% linen 150 m/100 g ... 700 g

TENSION: Stocking stitch
10 cm/18 stitches, 24 rows
(Tension Dial 7)

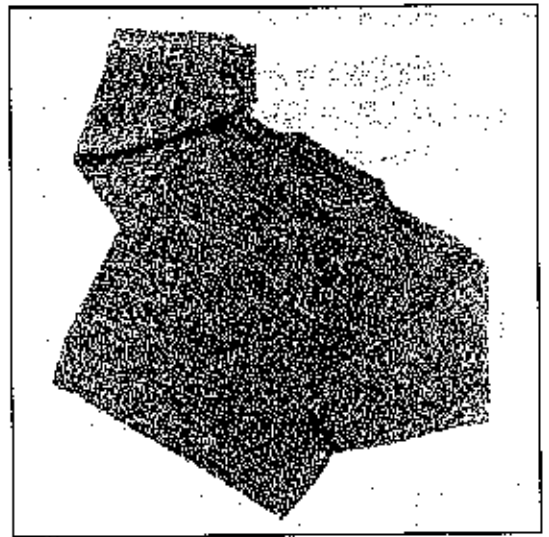
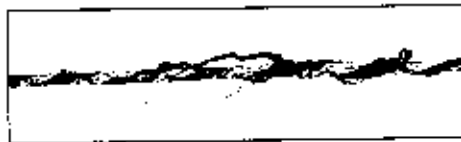

DIAGRAMS

All measurements are given in cms. Figures in bracket show stitches and rows.

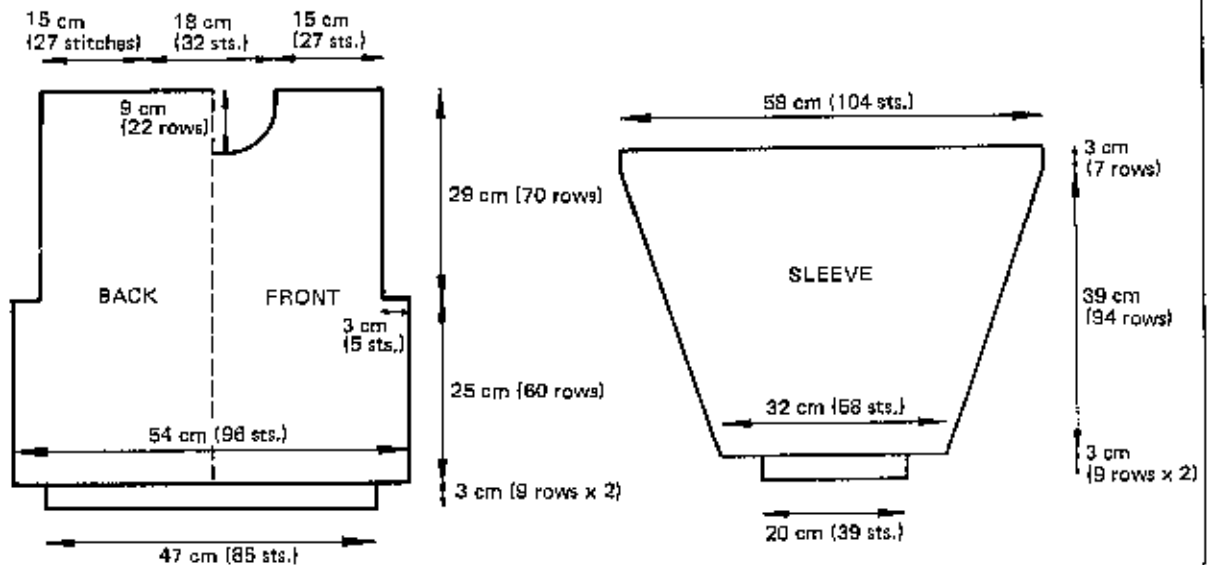

BACK

1

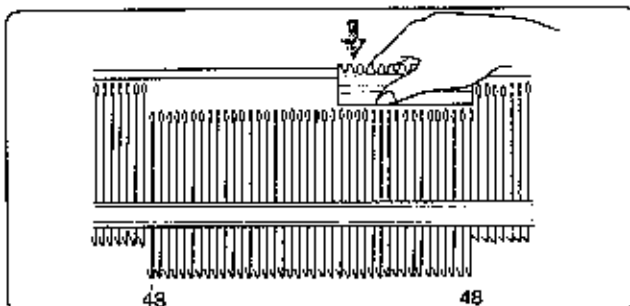

Place the Carriage at the left-hand side of the needlebed. Push 96 needles into B position using the flat side of the Needle Pusher.

2

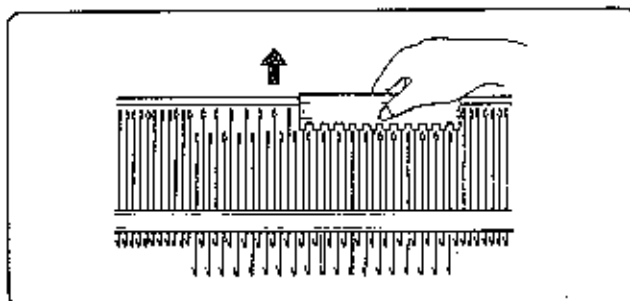

Using the Needle Pusher, push back to A position every other needle. Set Tension Dial to 7.

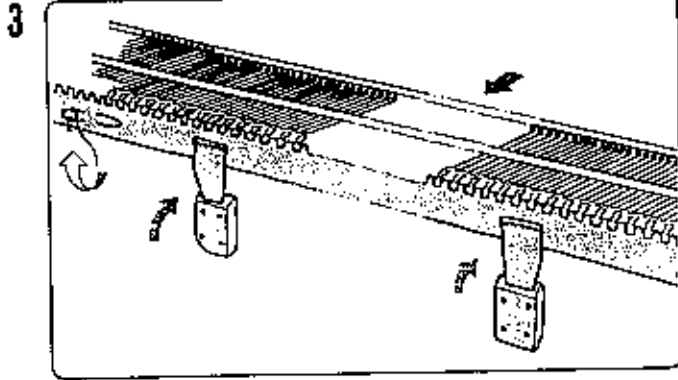

Knit 1 row with the waste yarn.
 Hang the Cast-on Comb and the Claw Weights.
 Place the end of the yarn under the Yarn Clip.
 Push into B position empty needles across work.

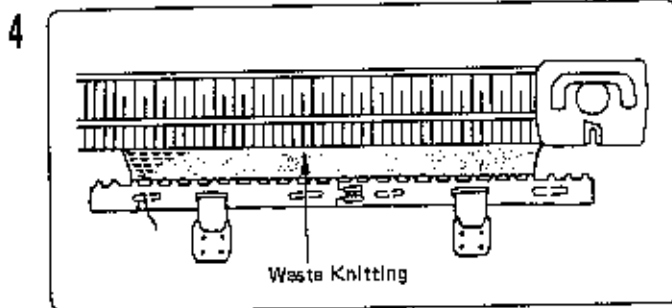

Knit a few rows ending with Carriage at the right.

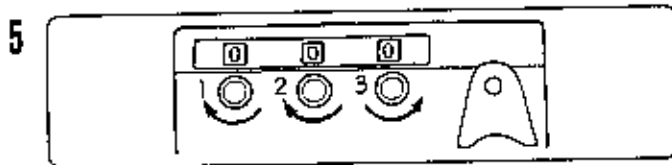

Set Row Counter to 000.

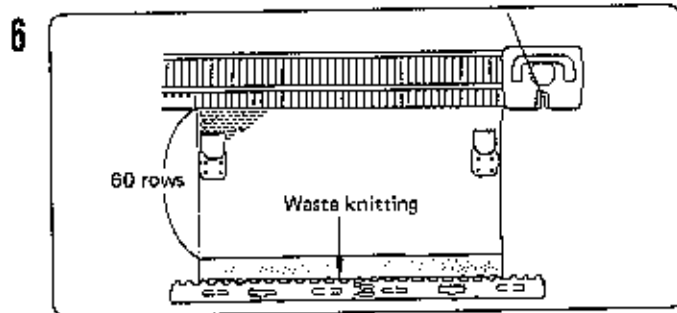

Change to main yarn. Knit 60 rows to underarm.

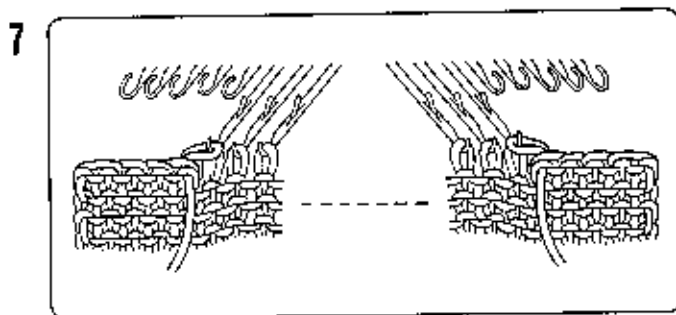

Cast off 5 stitches at right, knit 1 row. Cast off 5 stitches at left in the same manner. *Refer to Method 3 page 47.

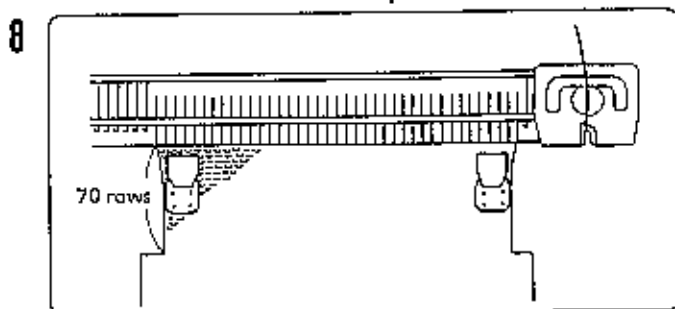

Knit 69 rows to neck edge until the Row Counter reads 130.

9

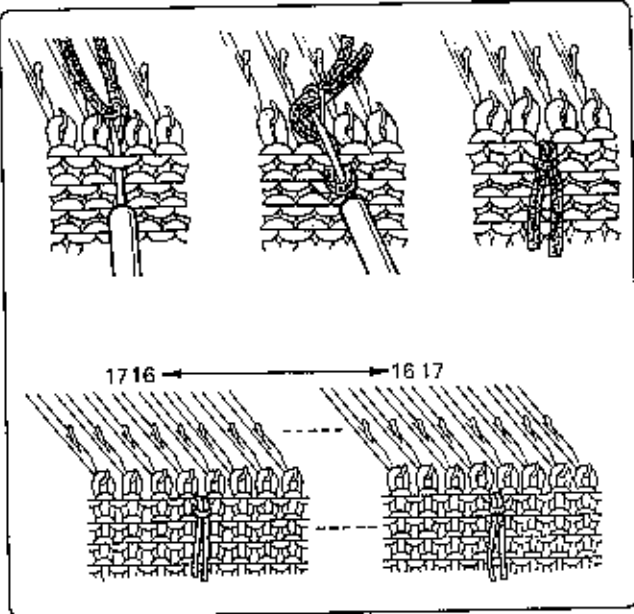

Place a waste yarn marker on sinker loops between 16 and 17 each side of centre to indicate neck opening. *Refer to page 17.*

10

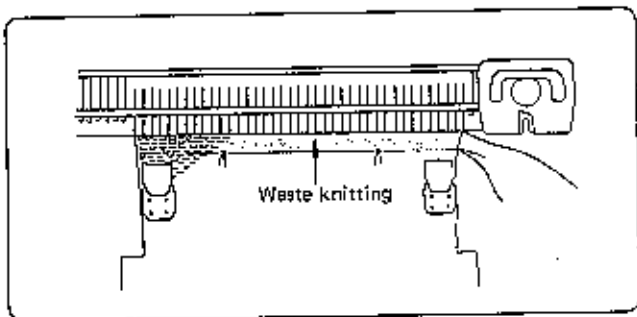

Change to waste yarn and knit a few rows. Break the waste yarn and remove it from the Yarn Feeder. Remove any Weights and Comb. Move the Carriage across the needlebed holding the garment in one hand and it will be released from the machine.

FRONT

1

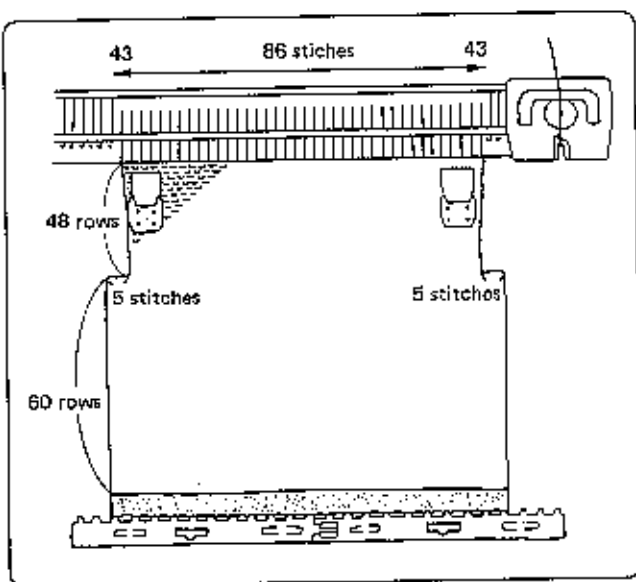

Work as BACK to beginning of front neck opening – the Row Counter reads 108.

2

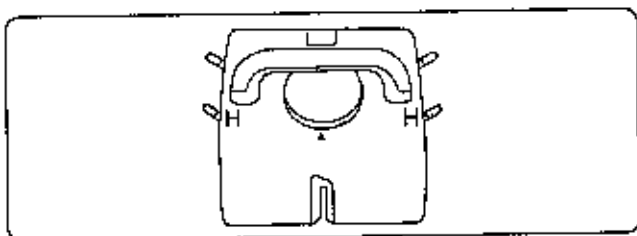

Set the Holding Cam Levers at each side of Carriage to H.

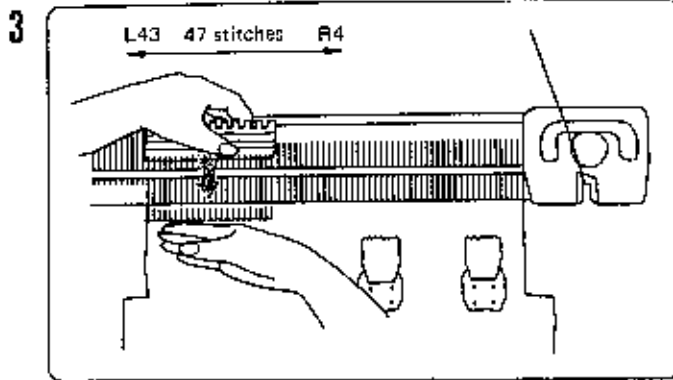

Push 47 needles (left 43 – right 4) needles at left hand side to E position.
Rehang the Claw Weights at each end of knitting.

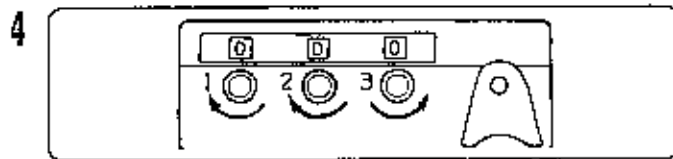

Set the Row Counter to 000.

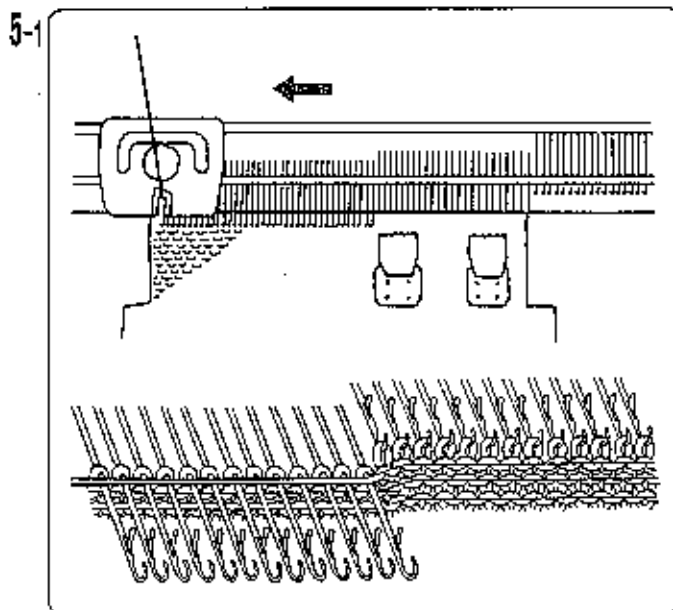

Knit the right shoulder.

1) Knit 1 row. *Needles in E position are not worked.

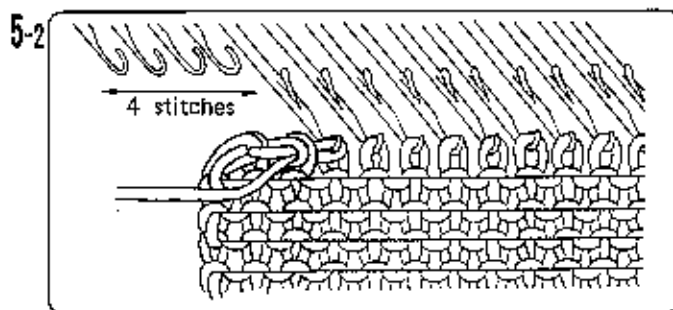

2) At the same side as the Carriage, decrease 4 stitches. *Refer to Method 1 page 47.*

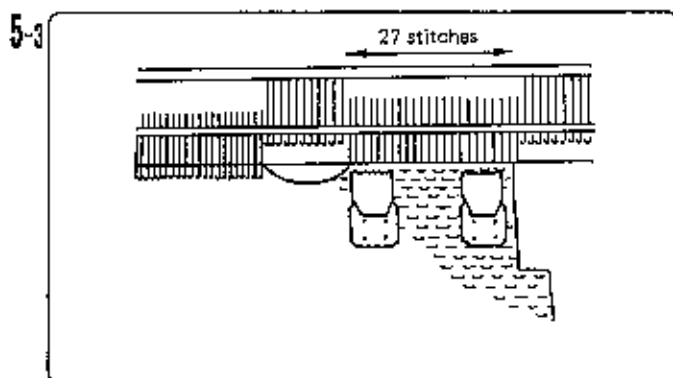

3) At the beginning of next and alternate rows, decrease 2 stitches x 2, then 1 stitch x 4. There are 27 stitches. Knit until the Row Counter reads 022.

5-1

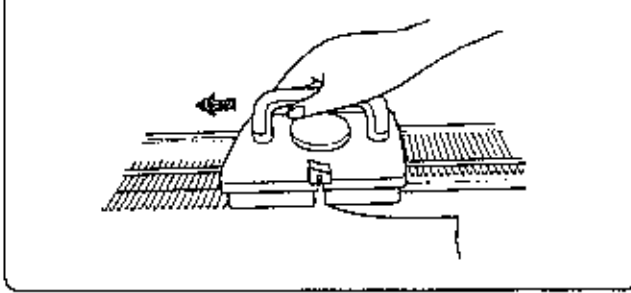

4) Change to waste yarn, knit a few rows. Remove the Weights and Cast-on Comb and release the knitting from the machine.

6

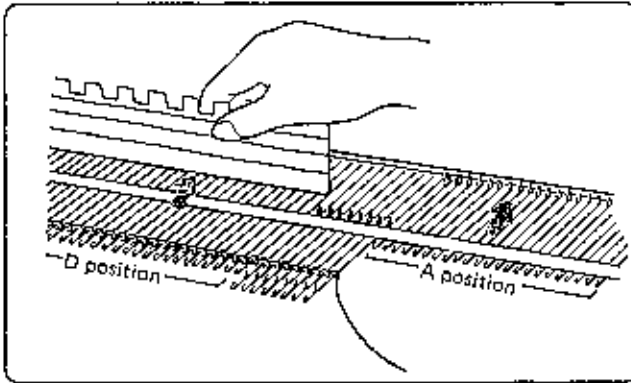

Place the Carriage at the left. Hang the Weight. Push the empty needles into A position. Push 39 needles (left 43 — left 5) at the left into D position, leaving 8 needles at the centre in E position.

7

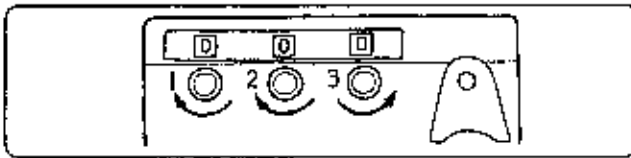

Set the Row Counter to 000.

8

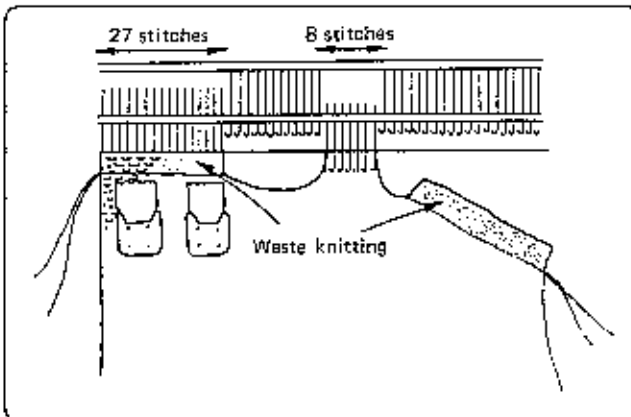

Work the left shoulder the same way as the right, reversing all shapings. Change to waste yarn, knit a few rows. Remove the Weights and release the knitting from the machine.

9

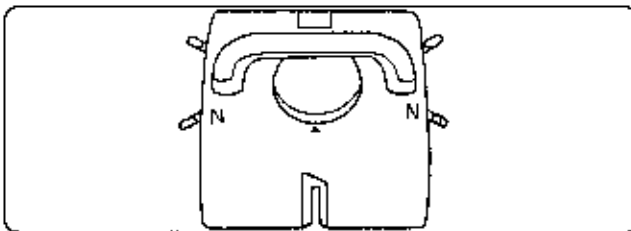

Push the empty needles into A position. Set the Holding Cam Levers to N.

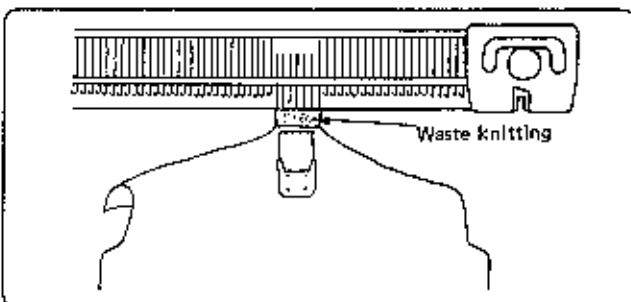

Knit a few rows in waste yarn and release the knitting from the machine.

SLEEVES

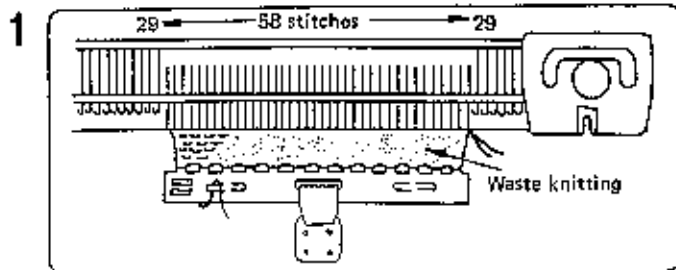

Knit a few rows with the waste yarn, 58 needles.
* Refer to page 23 – 24 (1 – 4).*

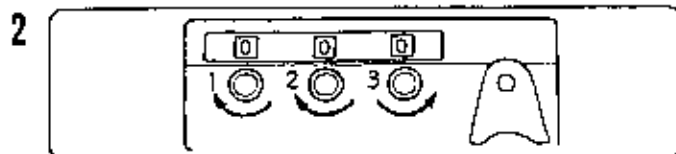

Set the Row Counter to 000.

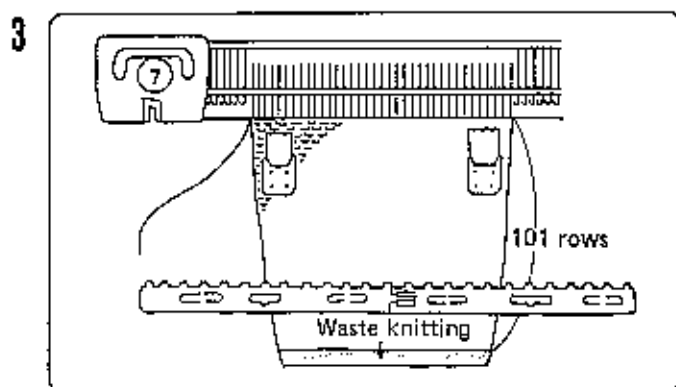

To knit the SLEEVE, Tension Dial at 7, knit 4 rows increasing one stitch at each end of next and every following 4 rows x 23. Knit until Row Counter reads 94. * Refer to Method 1 page 48.* Knit 7 rows without increasing. Break the main yarn leaving a length of approximately 3 times the width of the knitting. Change to waste yarn, knit a few rows and release work from machine.

MAKE-UP

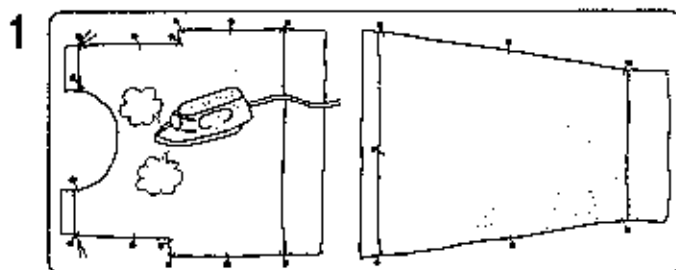

BLOCK AND PRESS: —

Lay all pieces of knitting, wrong side up, on a blocking surface and gently coax it into the correct shape and size. Pin the knitting to the surface and press. Turn over to the right side and press gently.

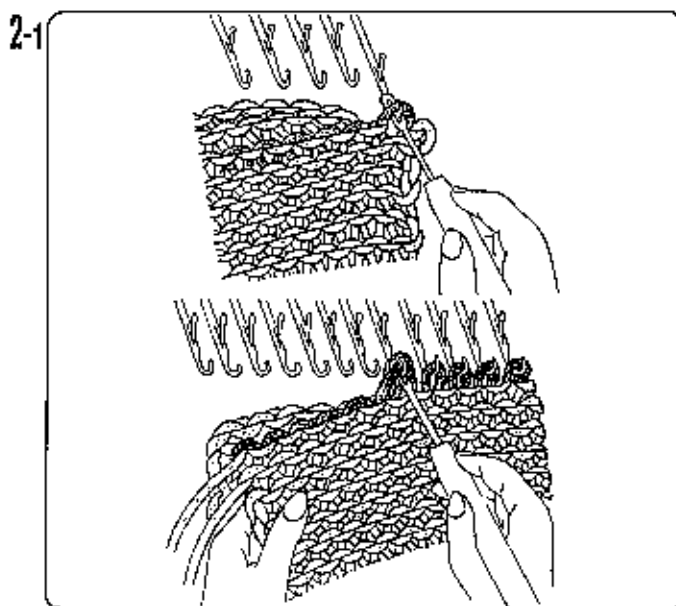

MAKE PLAIN HEM FOR BODICE & SLEEVE

1. BODICE

- 1) Place the Carriage at the left. Push 85 needles into B position. With the wrong side of the BODICE facing you, fold the waste knitting away from you. Pick up sinker loops of the first row worked in main yarn by overlapping the stitches on every 8th needles.

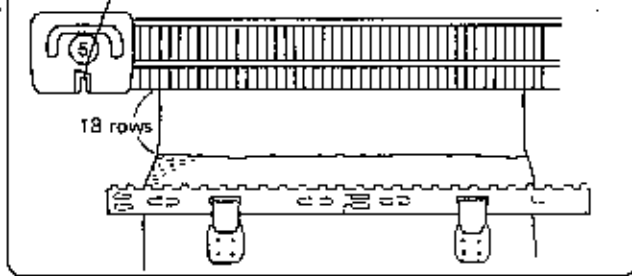

sion Dial to 5. Set the Row Counter to 000. Knit 18 rows in main yarn.

2-3

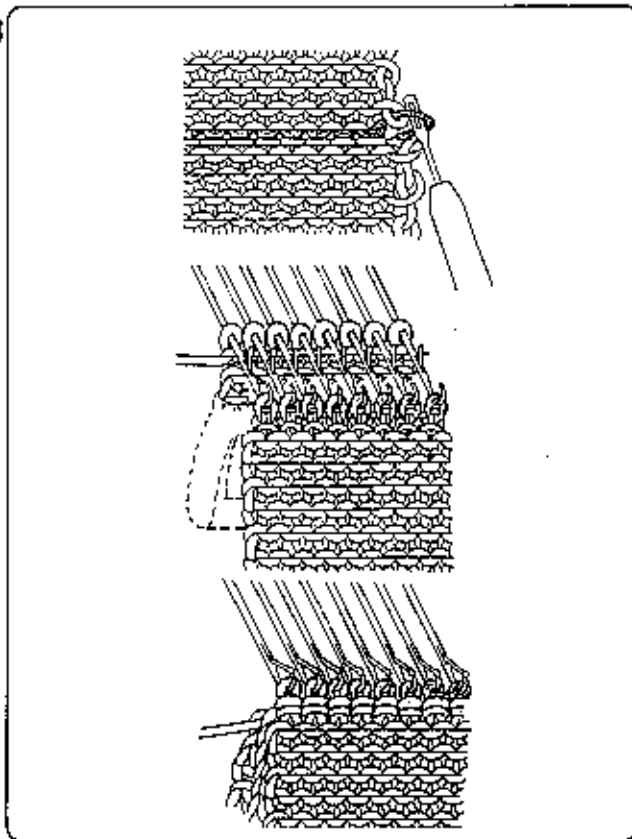

- 3) Remove the Weights and Comb. Push the needles to E position and push them back D position. Pick up all sinker loops of the first row for hem and hook them onto corresponding needles. Push the needles back to B position to make a single stitch. Cut the yarn leaving 3 times of the knitting. Bind off all stitches with a Tapestry Needle. *Refer to page 54,* Remove the waste knitting.

SLEEVE

Push 39 needles into B position. Pick up all the sinker loops of the first row by overlapping stitches every other needle. Make plain hem for SLEEVE in the same way as for BODICE.

3-1

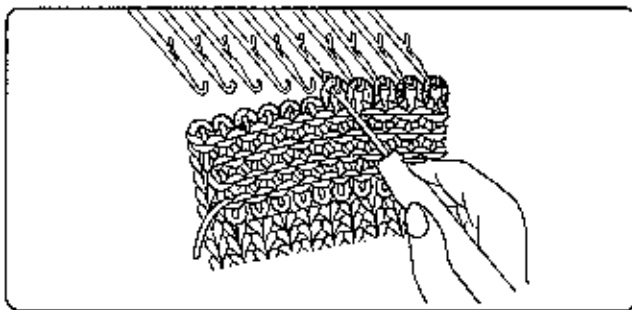

JOIN THE RIGHT SHOULDER: —

- 1) Bring forward to B position 27 needles. Hold the right side of the FRONT facing you. Folding the waste knitting towards you, replace the stitches onto the needles.

3-2

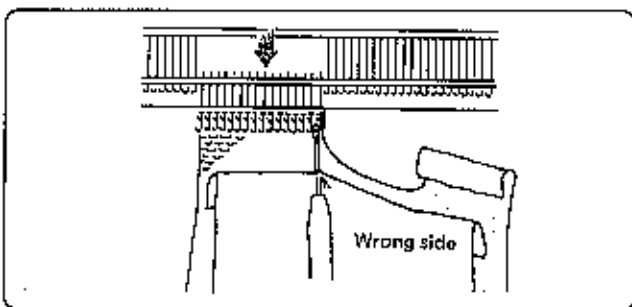

- 2) Push the needles into E position holding the knitting so that it does not come towards you. With the wrong side of the BACK facing you, working from the waste yarn marker, fold the waste knitting away from you, place the stitches into the hooks of the needles.

3-3

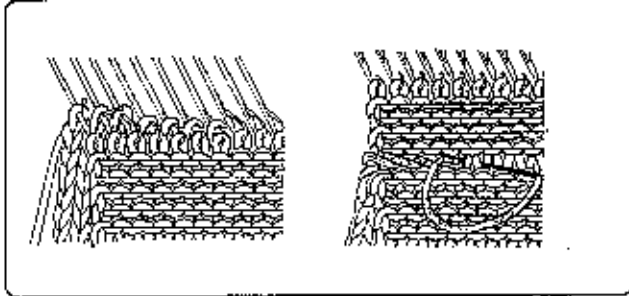

3) Push all the needles back to B position, the stitches in the needle hooks will be pulled through the stitches already on the needles to make a single stitch. Break yarn leaving a length of approximately 3 times the width of the knitting. Using a Tapestry Needle bind off. *Refer to page 54.* Remove the waste knitting for the shoulder.

4

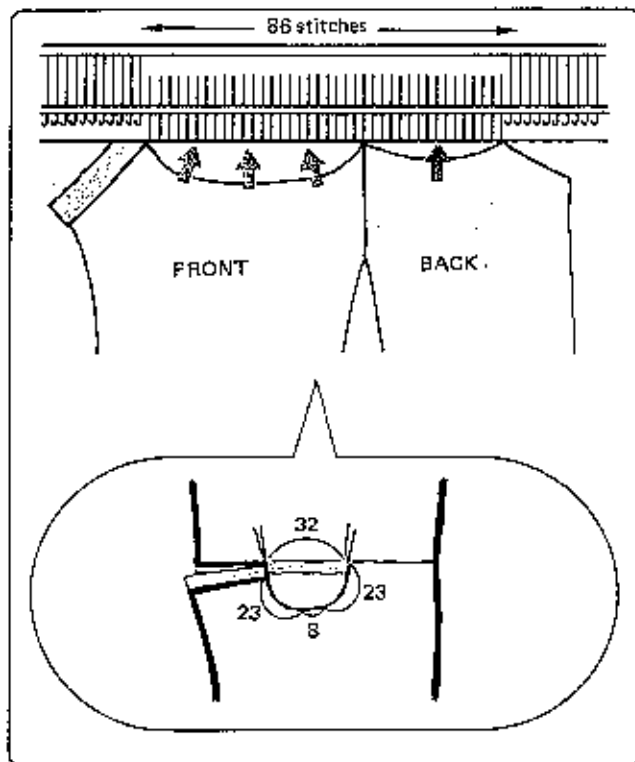

KNIT THE NECKBAND: —

1) Place the Carriage on the left-hand side. Push 86 needles into B position. With the wrong side of the BODICE facing you, pick up the stitches from neck edge and place onto needles as illustrated. Hang the Cast-on Comb and Weights.

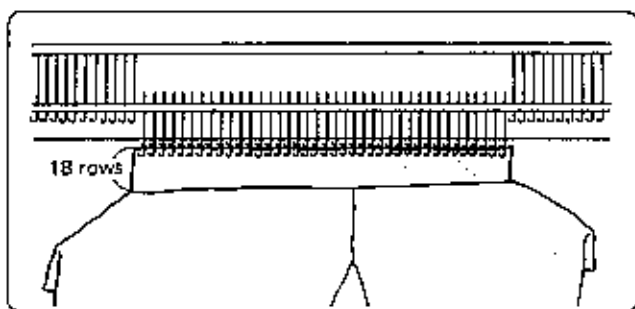

- 2) Set the Tension Dial to 5. Set the Row Counter to 000. Knit 18 rows in main yarn.
- 3) Push the needles to E position and push them back to D position. Using the Transfer Tool, pick up all sinker loops of the second row and hook them onto the needles. Bind off stitches with a Tapestry Needle. *Refer to page 54.*
- 4) Join the left shoulder in the same way.

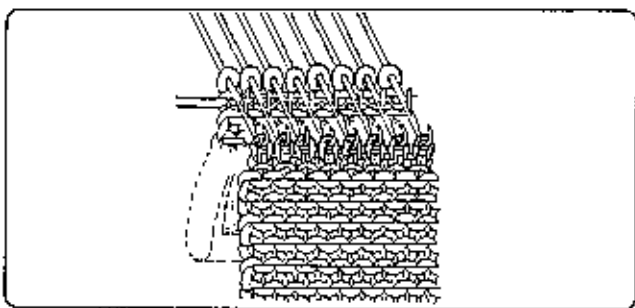

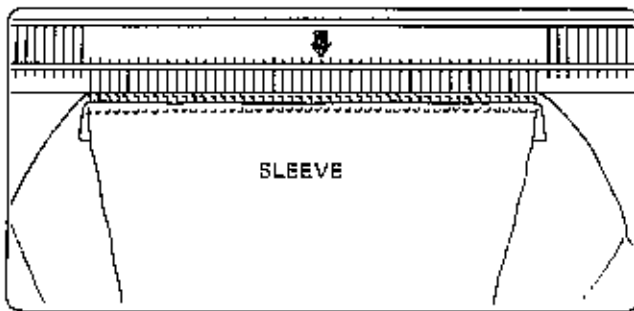
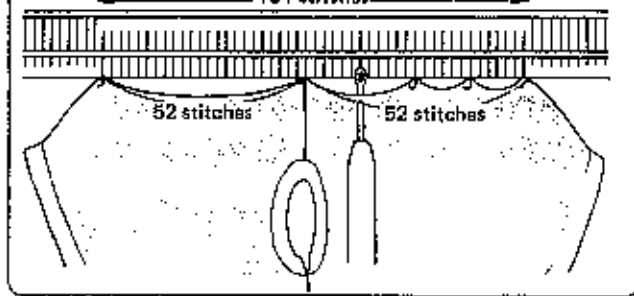

- 1) Push 104 needles into B position. With right side of the BODICE facing you, pick up the same number of stitches evenly along armhole edge and place onto needles.
- 2) Holding the knitting so that it does not come towards you, push the needles into E position. With the wrong side of the sleeve facing you, pick up the stitches from last row knitted in main yarn and place into the hooks of the needles.
- 3) Push the needles back to B position in order to make a single stitch. Using a Tapestry Needle bind off row knitted in main yarn. *Refer to page 54.* Remove the waste knitting for the sleeve.

6

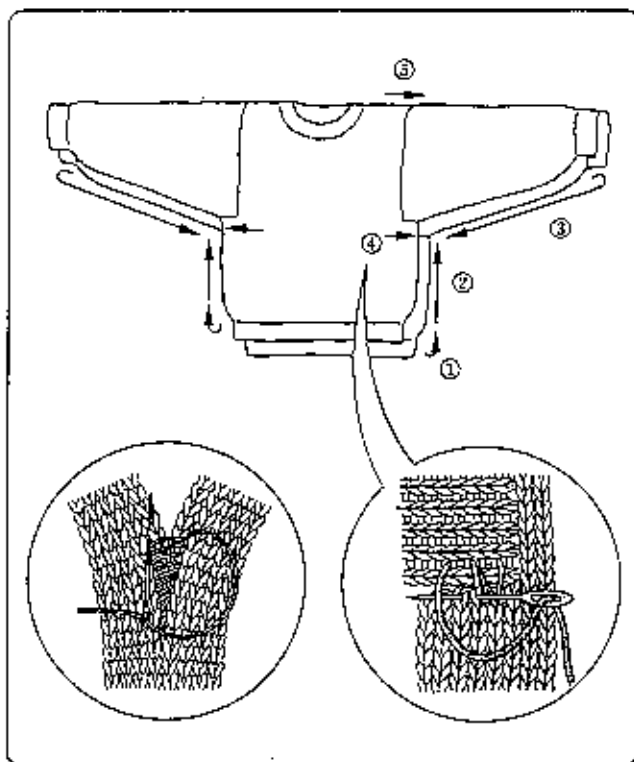

JOIN SEAMS. *Refer to page 56.*

- 1) Place two seam edges side by side, wrong side up. Begin at the first row of hem. Using mattress stitch close cuff seam, first on the inside and then on the outside.
- 2) Mattress stitch to underarm.
- 3) Mattress stitch SLEEVE seams.
- 4) Mattress stitch side seams.
- 5) Mattress stitch COLLAR seams, first on the inside and then the outside.
- 6) Sew in yarn ends and give final press.

3

LADY'S CARDIGAN

SIZE: To fit 96 cm bust

FINISHED MEASUREMENT: 112 cm

MATERIALS: 100% wool,
80 m/100 g ... 550 g,
2 cm buttons (5 pcs.)

TENSION: Stocking Stitch
10 cm/17 stitches, 23 rows
(Tension Dial 8)

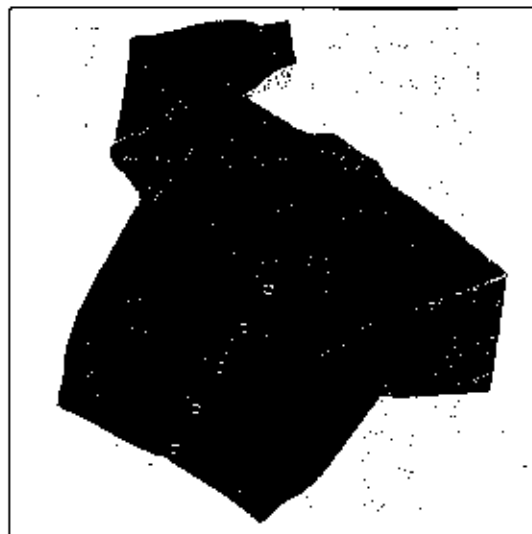
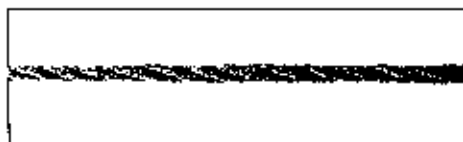

DIAGRAMS

All measurements are given in cms. Figures in brackets show stitches and rows.

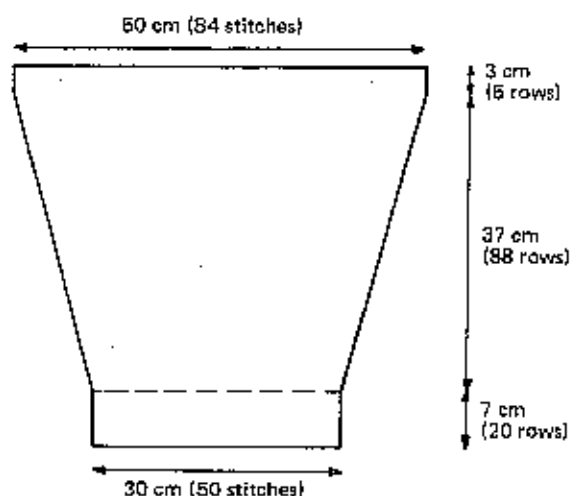
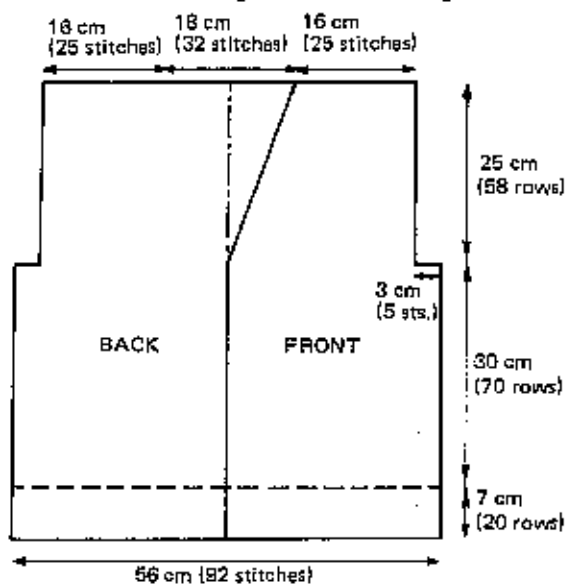

BACK

1

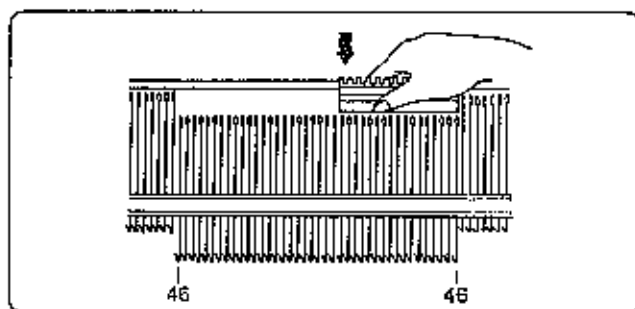

Place the Carriage at the left-hand side of the needlebed. Push 92 needles into B position.

2

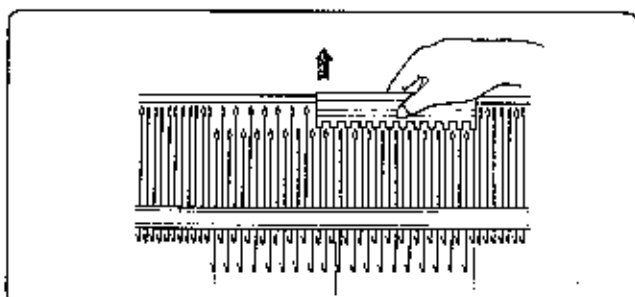

Using the Needle Pusher, push back to A position every other needle. Set the Tension Dial to 5.

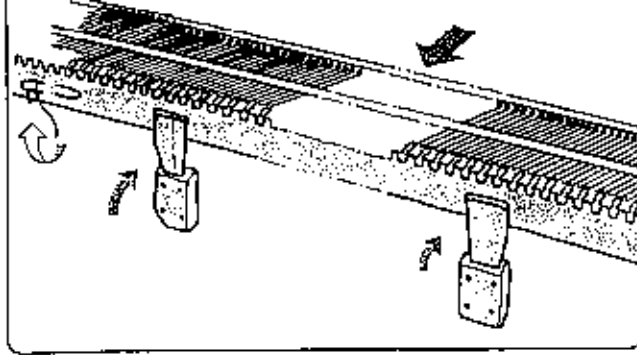

Comb and the Claw Weights. Place the end of the yarn under the Yarn Clip. Push into B position empty needles across work.

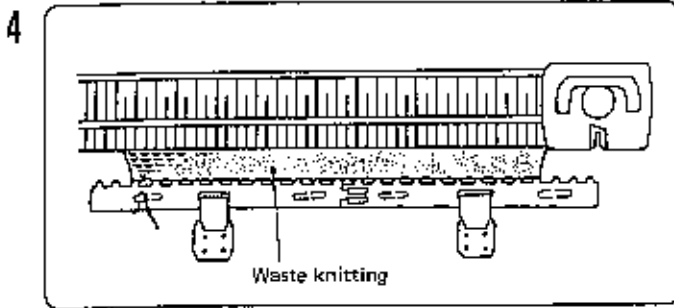

Knit a few rows ending with Carriage at the right.

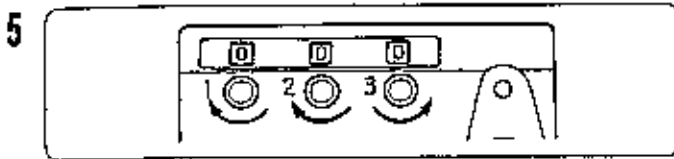

Set the Row Counter to 000.

Change to main yarn and knit 20 rows. Remove the Weights and the Cast-on Comb.

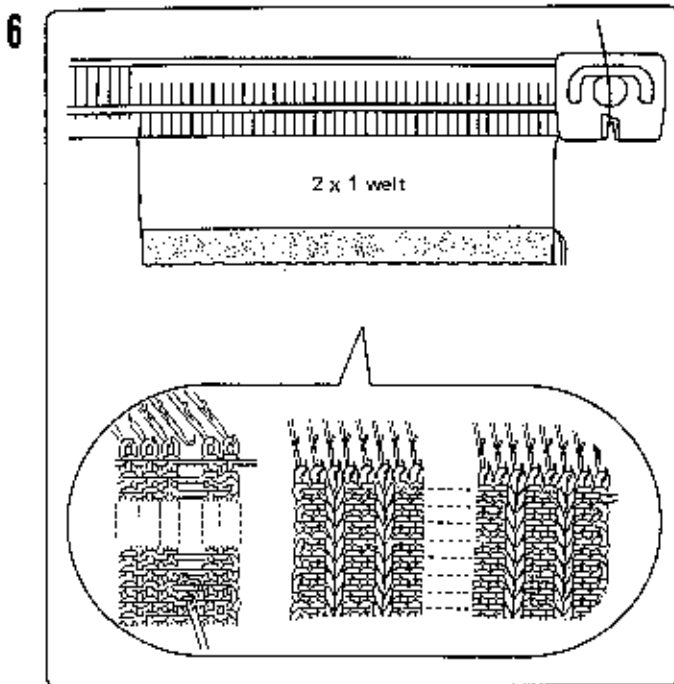

Make a 2 x 1 welt. Make purl stitches from the first row knitted in main yarn every third needle.
Refer to page 46.

7

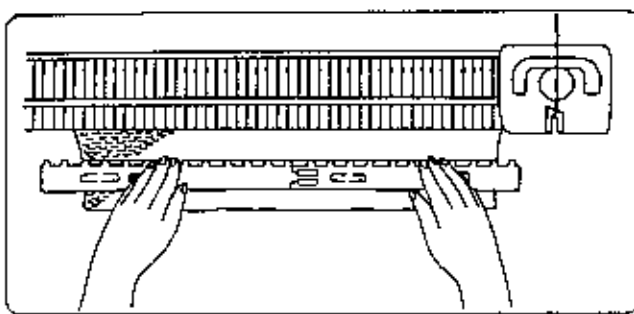

Rehang the Cast-on Comb and the Weights.

8

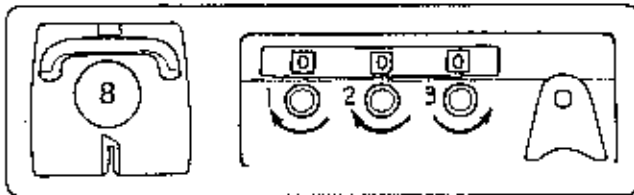

Set the Tension Dial to 8 and set the Row Counter to 000.

9

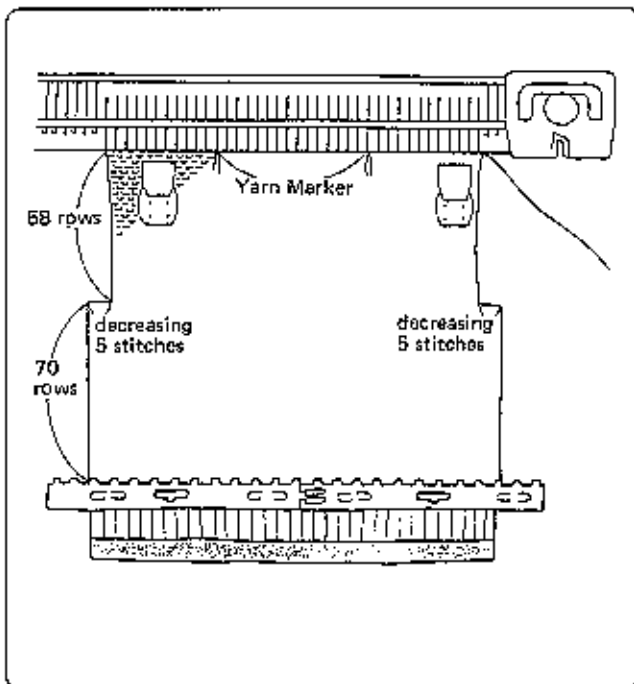

Knit the BACK as follows: -

- 1) Knit 70 rows to underarm. At the same side as the Carriage, cast off 5 stitches. Knit 1 row. At the same side as the Carriage, cast off 5 stitches. * Refer to Method 3 page 47.*
- 2) Knit 57 rows to neck edge. The Row Counter reads 128.
- 3) Place a waste yarn markers on sinker loops between 16 and 17 each side of centre to indicate neck opening. * Refer to page 17.*
- 4) Change to waste yarn and knit a few rows. Release the garment from the machine.

FRONT

1

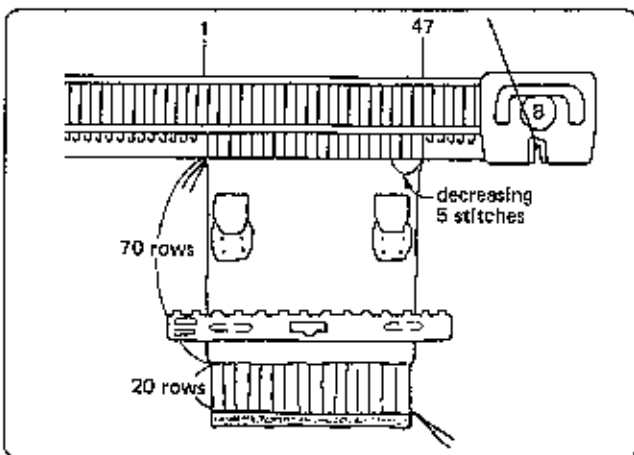

- 1) Push needles between 1 and 47 on the right-hand side of the needlebed.
- 2) Work 2 x 1 welt to match BACK. * Refer to steps 2 - 7. * Set the Tension Dial to 8. Set the Row Counter to 000. Knit 70 rows to underarm, Carriage at the right.
- 3) At the beginning of the next row, cast off 5 stitches to match BACK.
- 4) Place a waste yarn marker at the left edge of work. * Refer to 12 on page 16.*

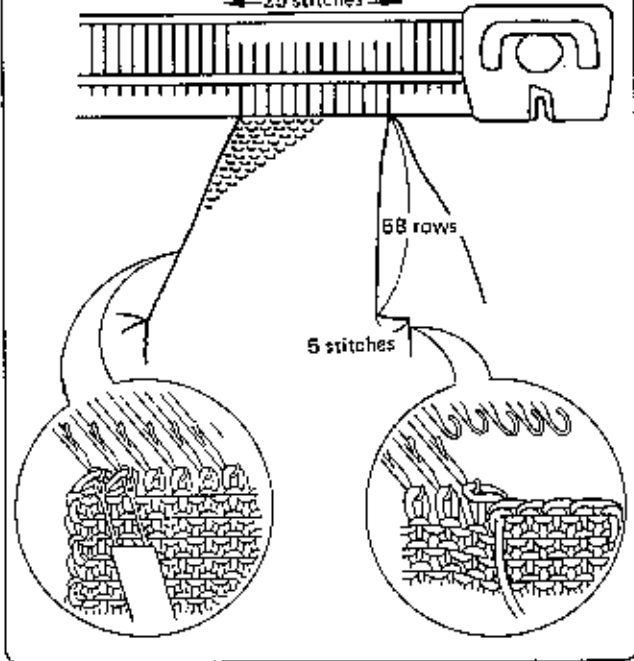

Shape the neck opening at the left edge by work by decreasing one stitch every 2 rows x 7, then every 4 rows x 10 until 25 stitches remain. Knit 4 rows. *Refer to Method 2 page 47.* The Row Counter reads 128. Change to waste yarn. Knit a few rows and release from machine.

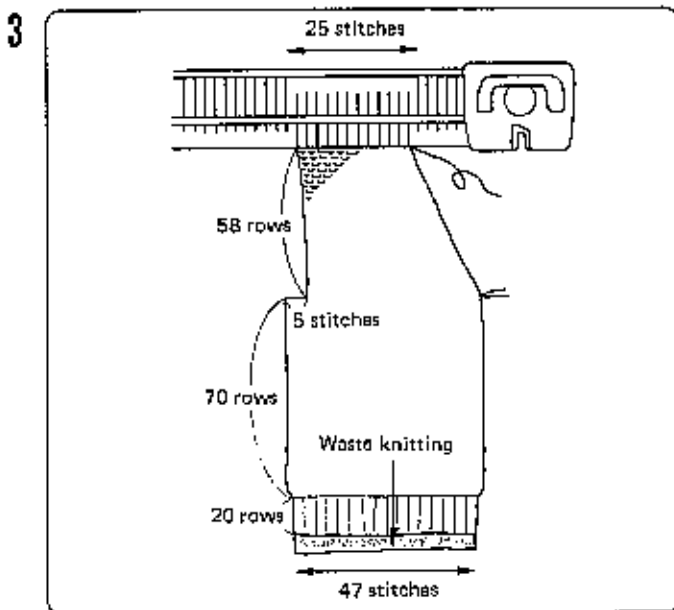

Work LEFT FRONT to match RIGHT FRONT reading left as right and vice versa.

SLEEVES

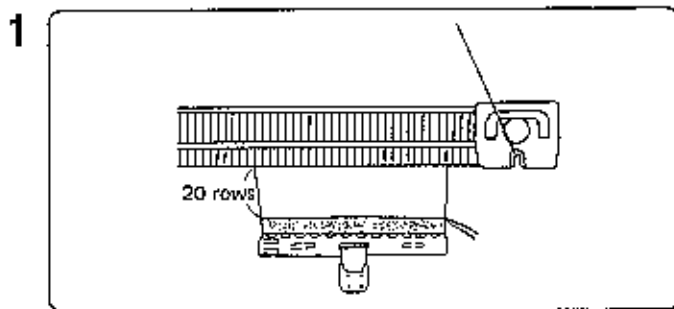

Work cuff using 50 stitches to match the welt of the BACK.*Refer to steps 1 – 7 on page 32–34.*

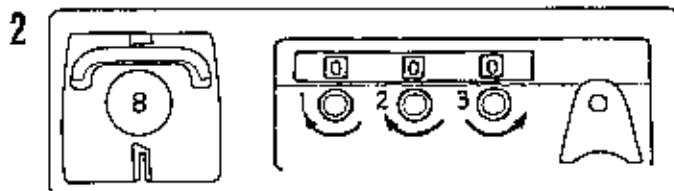

Set the Tension Dial to 8. Set the Row Counter to 000.

3

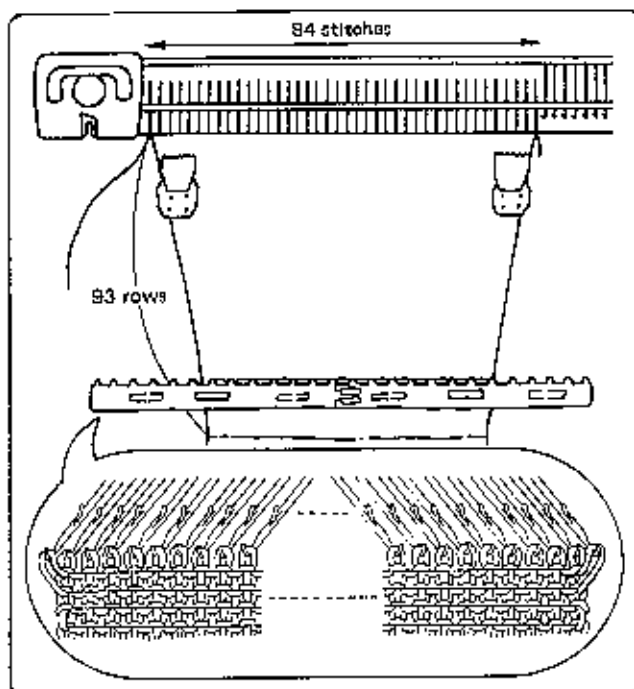

To knit the SLEEVES, knit 4 rows. Increase one stitch at each end of next and every following 4 row x 8, then every following 6 row x 9. The Row Counter reads 88. Knit 5 rows without increasing. *Refer to Method 1 page 48.* Break the main yarn leaving length of approximately 3 times the width of knitting. Change to waste yarn, knit a few rows and release from machine.

NECKBAND/BUTTON BAND/BUTTON HOLE BAND

1

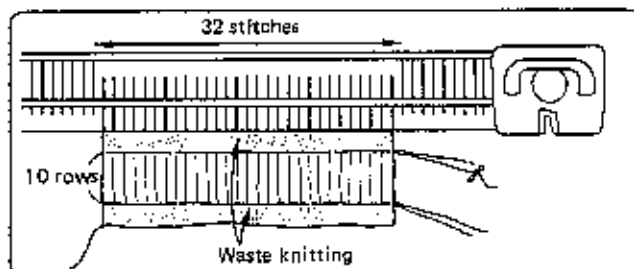

NECKBAND: Push 32 needles into B position. Make 2 x 1 welt to match BACK, knit 10 rows Tension Dial 5. Break the yarn leaving length of approximately 3 times the width of the knitting. Change to waste yarn and knit a few rows. Take off the knitting from the machine.

2

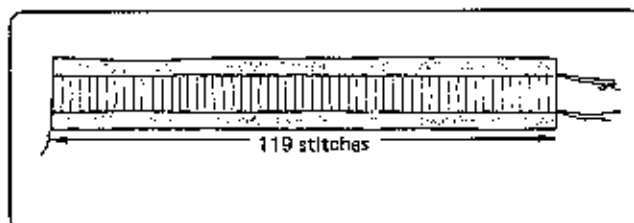

BUTTON BAND: Push 119 needles into B position. Make a 2 x 1 welt to match BACK, knit 10 rows, Tension Dial 5. Break the yarn leaving length of approximately 3 times the width of the knitting. Change to waste yarn and knit a few rows. Take off the knitting from the machine.

3

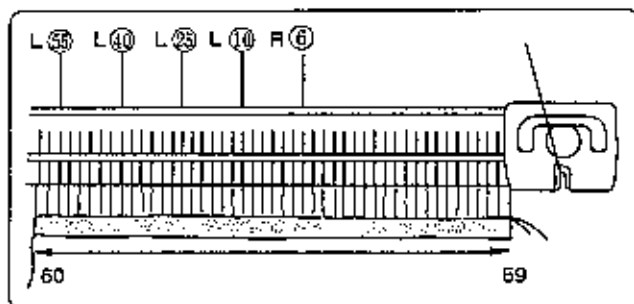

BUTTON HOLE BAND: Push 119 needles into B position and knit 4 rows, Tension Dial 5. Decide buttonhole positions. Make purl stitches at the needles of Left 55, 40, 25, 10 and Right 6. Transfer one stitch to its adjacent needle leaving empty needles in B position. Knit 6 rows. Make 2 x 1 welt to match BACK. Break the yarn leaving length of approximately 3 times the width of knitting. Change to waste yarn and knit a few rows. Take off the knitting from the machine.

HOW TO MAKE A BUTTON HOLE

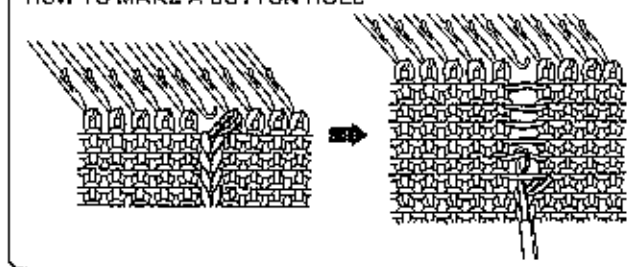

4

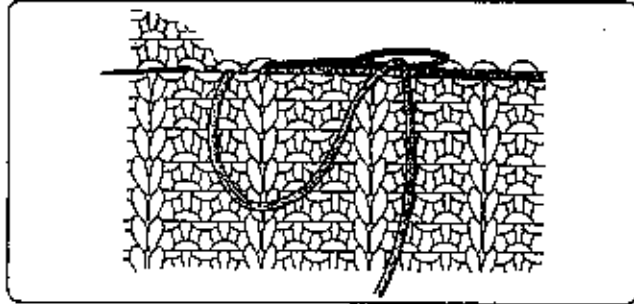

Bind off the last row of NECK BAND, BUTTON BAND and BUTTON HOLE BAND. Remove the waste knitting. *Refer to page 51.*

MAKE-UP

1

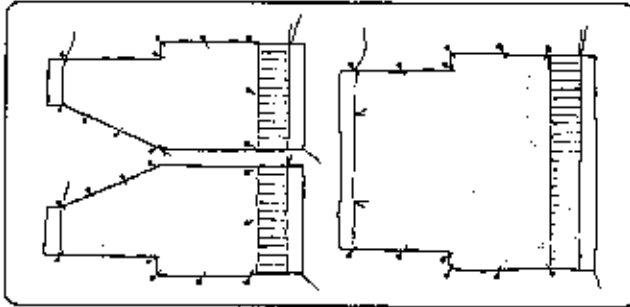

BLOCK AND PRESS: —

Lay all pieces of knitting, wrongside up on a blocking surface and gently coax into the correct shape and size. Pin the knitting to the surface and press avoiding the welts. Turn over to the right side and press gently.

2

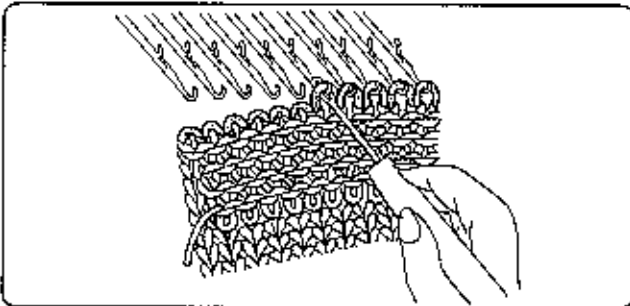

JOIN BOTH SHOULDERS: —

1) Push into B position 25 needles. Hold the right side of the FRONT facing you. Folding the waste knitting towards you, replace the stitches onto the needles.

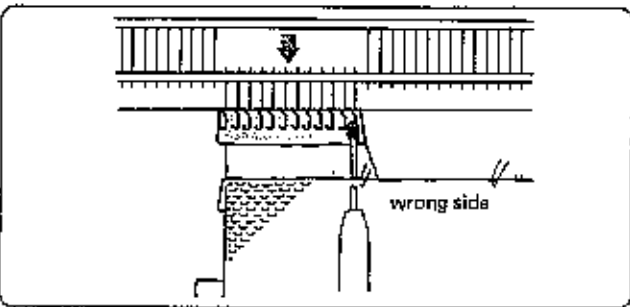

2) Push the needles into E position. Hold the wrong side of the BACK facing you. Folding the waste knitting away from you, place the stitches into the hooks of the needles.

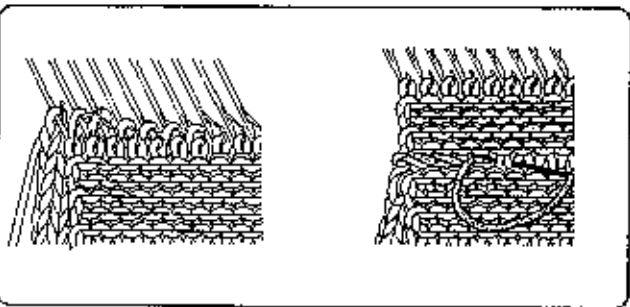

3) Push the needles back to B position in order to make a single stitch. Using a Tapestry Needle bind off the row knitted in main yarn. *Refer to page 54.* Remove the waste knitting for the shoulder.

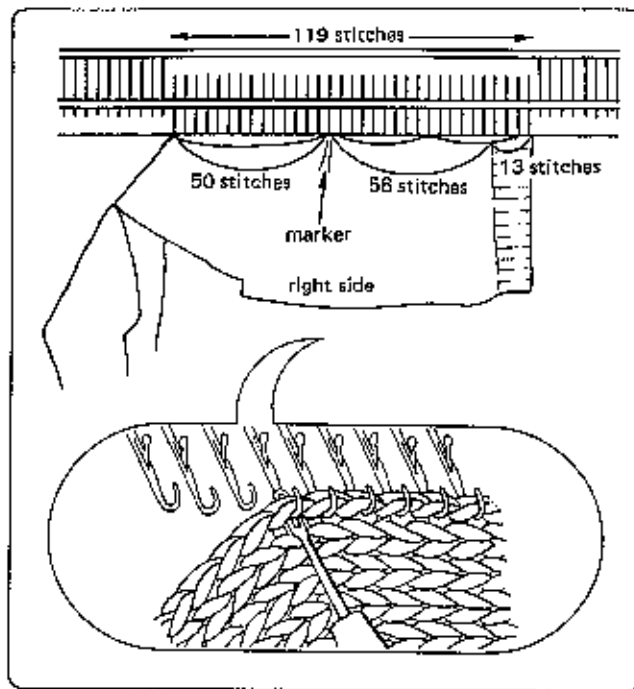

ATTACH THE BUTTON BAND, THE NECK-BAND, AND THE BUTTON HOLE BAND TO THE BODICE: —

1) Push 119 needles into B position. With the right side of the FRONT facing you, pick up stitches evenly along front opening and place them onto needles.

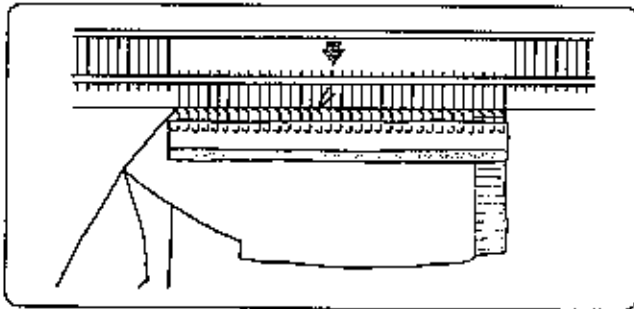

2) Holding the knitting so that it does not come towards you, push the needles into E position. With the wrong side of the BUTTON HOLE BAND facing you, replace stitches from the first row knitted in main yarn into hooks of the needles.

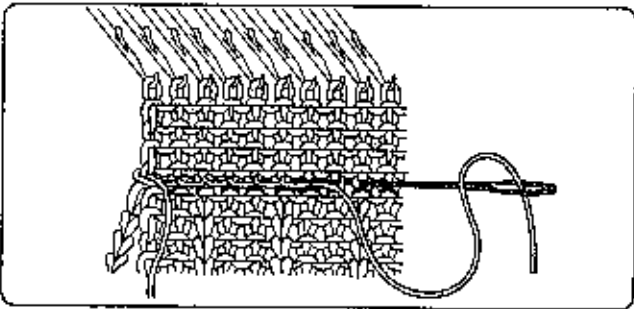

3) Push the needles back to B position in order to make a single stitch. Using a Tapestry Needle bind off the row knitted in main yarn. *Refer to page 54.* Remove the waste knitting.

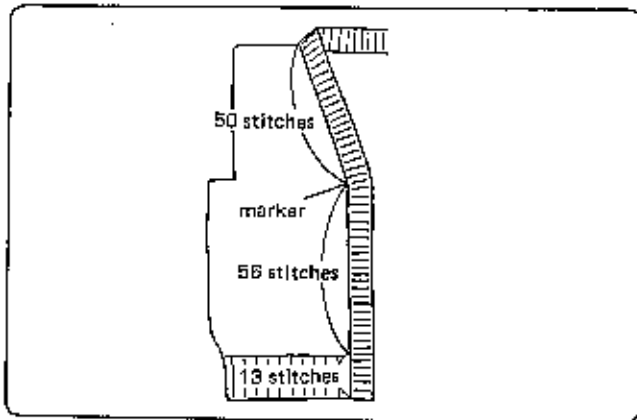

4) Join the BUTTON BAND to the left FRONT opening in the same way.
5) Join the NECKBAND to the back neck using 32 needles in the same way.

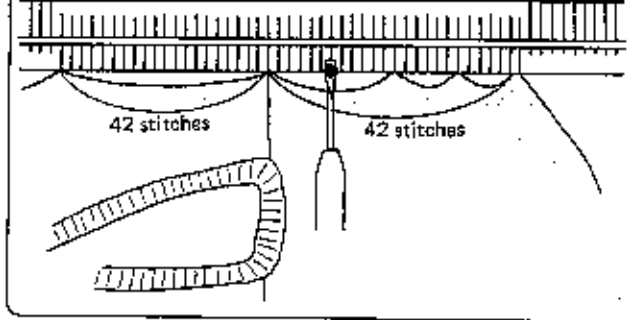

ATTACH THE SLEEVE TO THE BODICE: —
 1) Push 84 needles into B position. With the right side of the BODICE facing you, pick up stitches evenly along armhole edge and place onto needles.

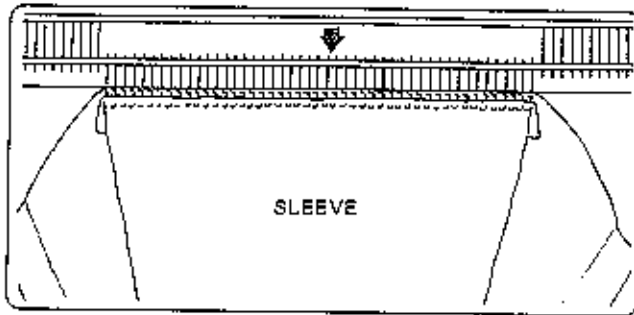

2) Holding the knitting so that it does not come towards you, push the needles into E position. With the wrong side of the sleeve head facing you place stitches from last row knitted in main yarn into the hooks of the needles.

3) Push the needles back to B position in order to make a single stitch. Using a Tapestry Needle bind off the last row knitted in main yarn. *Refer to page 54.* Remove the waste knitting for the sleeve.

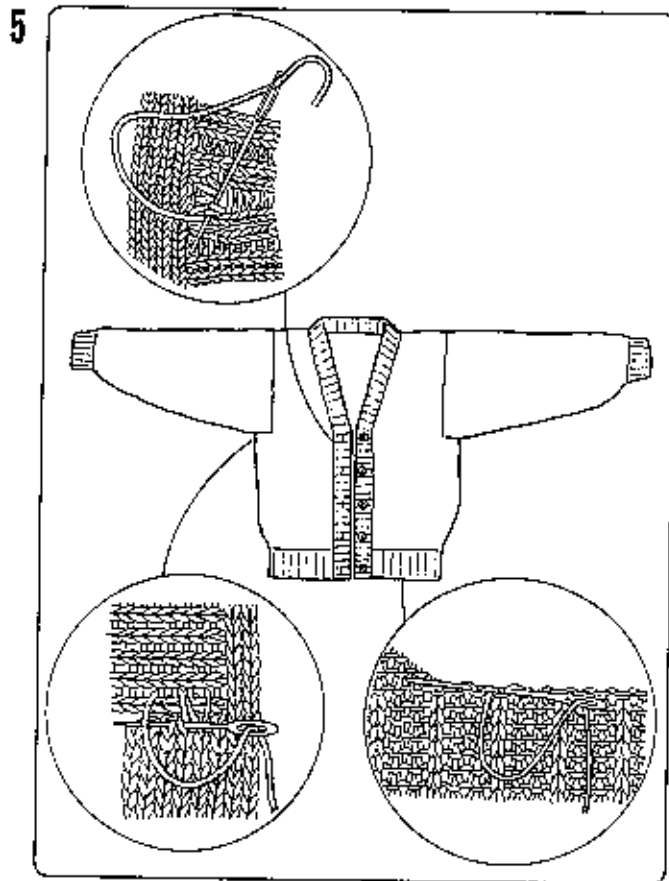

1) Using a Tapestry Needle bind off the stitches from the first row knitted in main yarn of the welts. *Refer to page 51.* Remove waste yarn.

2) Using mattress stitch join side and sleeve seams: — *Refer to page 55.*

3) Using mattress stitch join neckband seams. Using blanket stitch, work around buttonholes from the right side.

4) Sew in yarn ends and give final press.

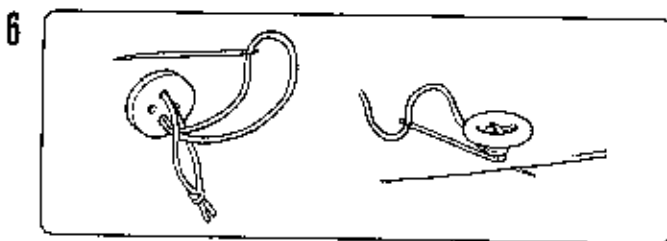

Attach buttons as illustrated.

PATTERN KNITTING

The following examples are a guide as to how to knit different types of stitch patterns with your machine. Once you have knitted through the exercises, and you see how the stitch patterns are formed, you will then be able to create your own designs. *Diagram shows the wrong side of the fabric (when you are knitting, the wrong side of the fabric is showing).

1 PULL-UP STITCH PATTERN (TUCK STITCH PATTERN)

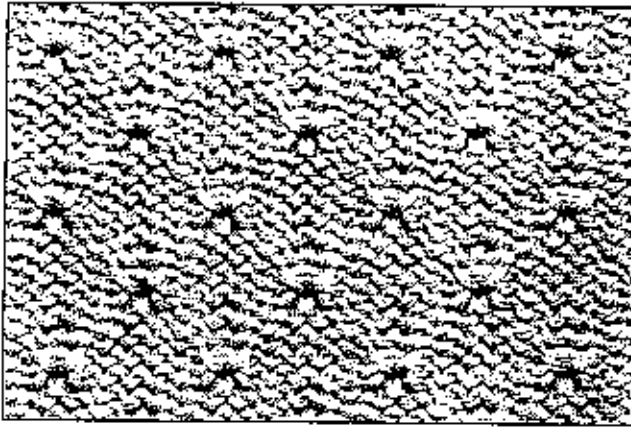

																					10	
																						9
																						8
																						7
																						6
																						5
																						4
																						3
																						2
																						1

Needle in E position

NOTE

Rehang the Cast-on Comb and Claw Weights every 20 rows or so to give an even tension. You cannot tuck more than 3 rows on one needle. You cannot tuck on the end needle.

2 SKIP STITCH PATTERN

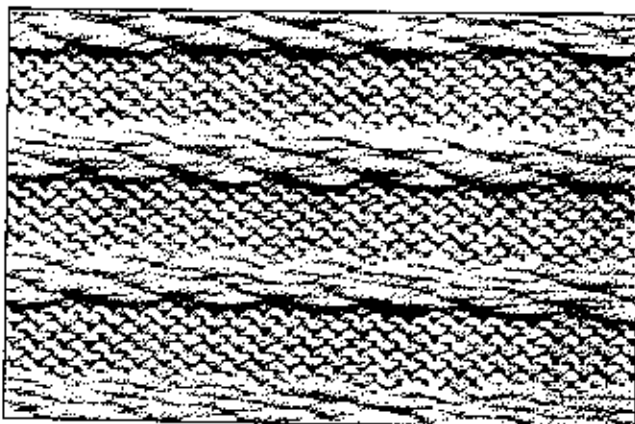

- 1) Knit several rows.
- 2) Using the Needle Pusher 1 x 5, bring forward every 6th needle to E position. * Refer to the 1st row on the diagram.*
- 3) Set the Holding Cam Levers to H. Knit three rows.



Yarn is held on those needles in E position.

- 4) Set the Holding Cam Lever to N (right one for the rightward, left one for the leftward movement).
- 5) Knit two rows.
- 6) Using the Needle Pusher 1 x 5, bring forward every 6th needle to E position. * Refer to the 6th row on the diagram.*
- 7) Set the Holding Cam Levers to H. Knit three rows.
- 8) Set the Holding Cam Lever to N (right one for the rightward, left one for the leftward movement).
- 9) Knit two rows.
- 10) Repeat steps 2) – 9).

- 1) Knit several rows.
- 2) Using the Needle Pusher 1 x 3, bring forward every 4th needle to D position. * Refer to the 1st row on the diagram.*
- 3) Set the Part Levers at each side of the Carriage to P. Knit one row.
- 4) Using the Needle Pusher 1 x 3, bring forward the needles next to ones you selected in step 2). * Refer to the 2nd row on the diagram.* Knit one row.
- 5) Selecting the needles according to the diagram, continue knitting until you have knitted 7 rows.
- 6) Set the Part Levers to N and knit 5 rows in stocking stitch.
- 7) Repeat steps 2) – 6).

														12
														11
														10
														9
														8
														7
														6
														5
														4
														3
														2
														1

NOTE

When the Part Levers is set to P, only needles in D and E position will knit.

☐ Needle in D position

3 MULTI-COLOUR SKIP STITCH PATTERN

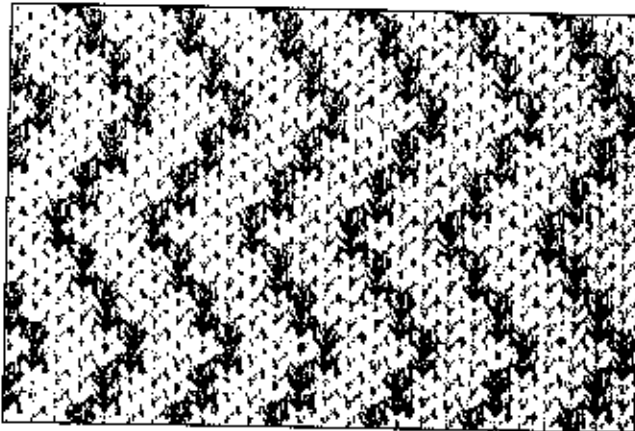

															24
															23
															22
															21
															20
															19
															18
															17
															16
															15
															14
															13
															12
															11
															10
															9
															8
															7
															6
															5
															4
															3
															2
															1

☐ Knit in contrast yarn. (Needle in D position)
 ☑ Knit in main yarn. (Needle in D position)

- Prepare two yarns — main yarn and contrast yarn
- 1) Knit several rows.
 - 2) Set the Part Levers at each side of the Carriage to P.
 - 3) Bring forward the needles to D position according to the 1st row of the diagram.

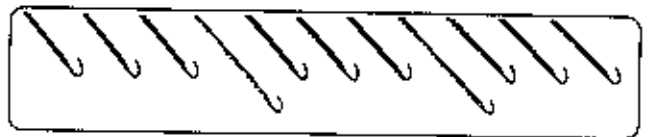

- 4) Knit one row in contrast yarn.
- 5) Bring forward the needles to D position according to the 2nd row of the diagram and knit one row with contrast yarn.
- 6) Bring forward the needles to D position according to the 3rd row of the diagram.

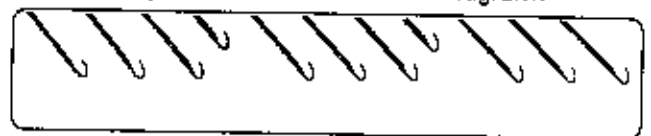

- 7) Knit one row in main yarn.
- 8) Bring forward the needles to D position according to the 4th row of the diagram and knit one row in main yarn.
- 9) Selecting the needles according to the diagram, continue knitting in yarns indicated on the diagram.

NOTE

When the Part Lever is set to P, only needles in D and E position will knit.

4 LACE PATTERN

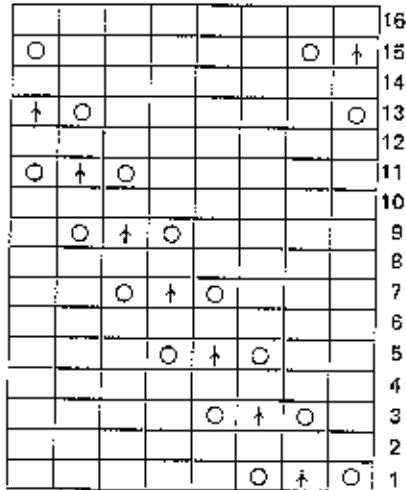
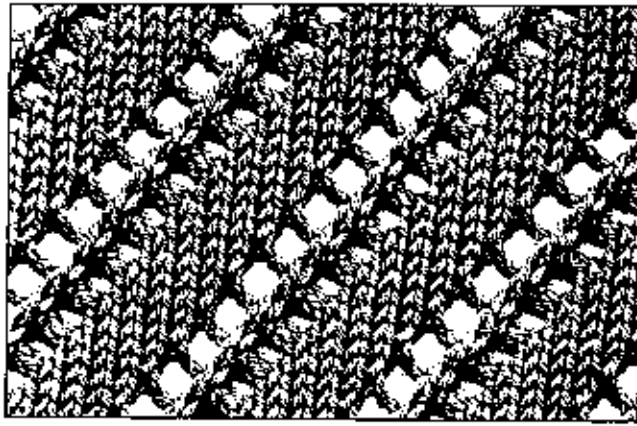

- 1) Knit several rows.
- 2) Transfer the stitches according to the first row of the diagram using the Transfer Tool.
Refer to "How to transfer stitches" on page 45.

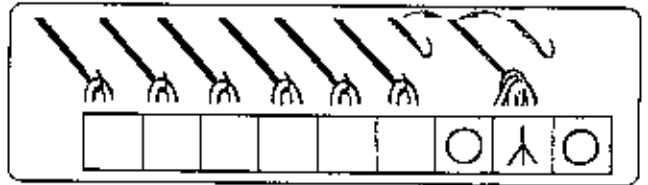

- 3) Make sure that all the needles are in B position. Knit two rows.
- 4) Transfer the stitches according to the 3rd row of the diagram.

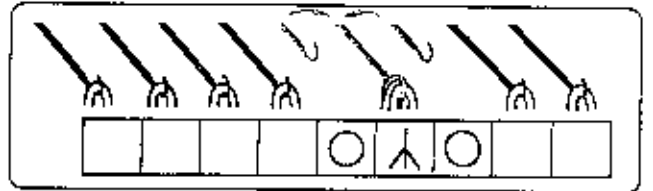

- 5) Make sure that all the needles are in B position. Knit two rows.
- 6) Transfer the stitches according to the diagram, continue in lace stitch pattern.

NOTE

If you cannot knit smoothly, bring forward the needles which have transferred stitches to E position.

5 KNIT & PURL STITCH PATTERN

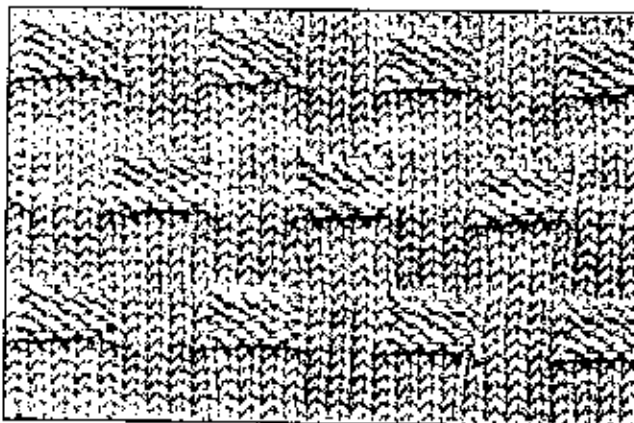

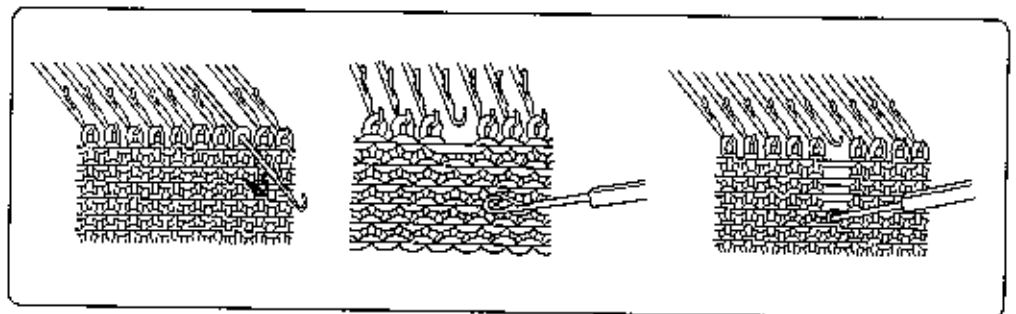

Purl stitches are worked with the Latchet Tool.

- 1) Knit ten rows.
- 2) Bring forward marked needle (5) on 10th row in the diagram to E position, then push it back to B position. The stitch will drop off the needle. Let the stitch run down the number of rows needed for each purl stitch.
- 3) Using the Latchet Tool pick up the stitch (one row below where the purl stitches will begin) (6th row, see the diagram).



																							20	
																								19
																								18
																								17
																								16
																								15
																								14
																								13
																								12
																								11
																								10
																								9
																								8
																								7
																								6
																								5
																								4
																								3
																								2
																								1
8	7	6	5	4	3	2	1																	

 Purl stitch
 Plain stitch

4) Catch the next horizontal bar above with the hook of the Latchet Tool with first stitch behind the latch. Then pull the Latchet Tool towards you. A purl stitch has been formed.

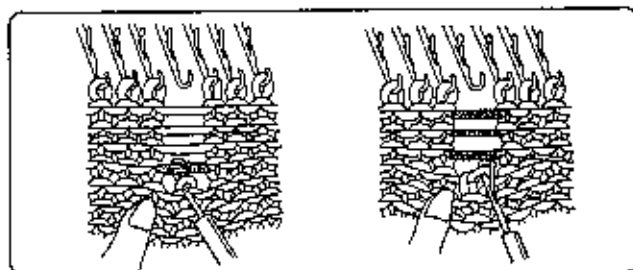

5) Continue in this way until you reach the last stitch. Hook the last stitch onto the needle.

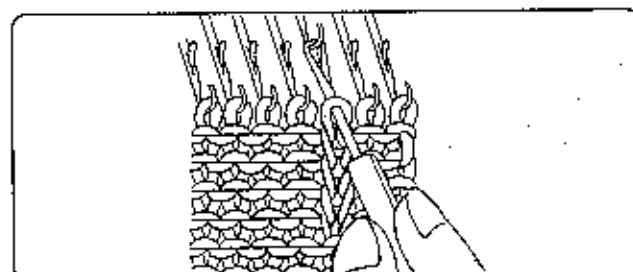

6) Repeat the above steps making the purl stitches according to the diagram.

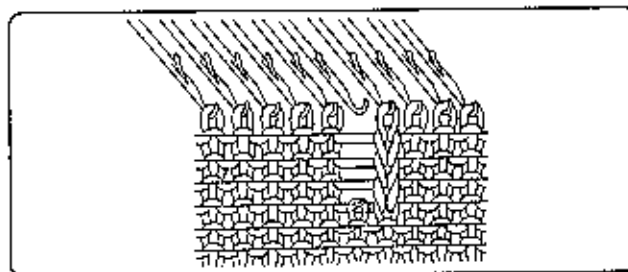

6 CABLE STITCH PATTERN

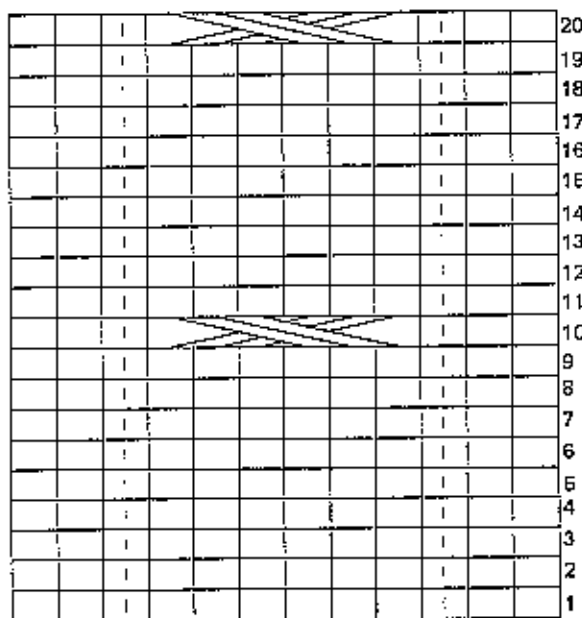
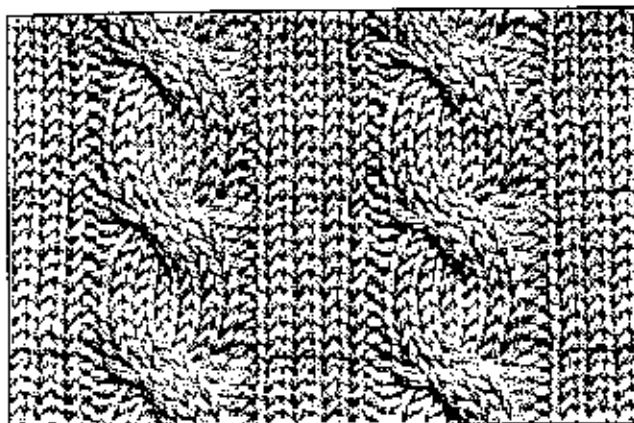

 Purl stitch

Cables are made by crossing two sets of stitches using two Transfer Tools. The following example uses two 3-eyed Transfer Tools.

- 1) Knit until you reach the point for your first cable crossover, for this example, knit 10 rows.
- 2) Drop one stitch on each side of the cable pattern stitches.

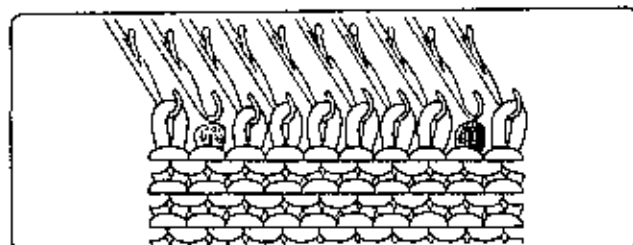

- 3) Cross the stitches as shown below.

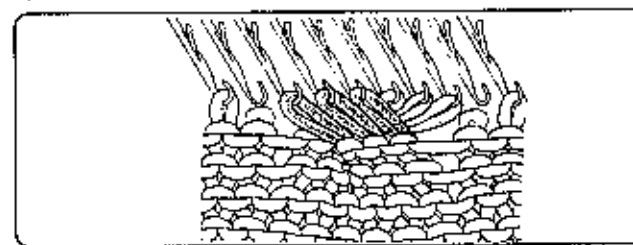
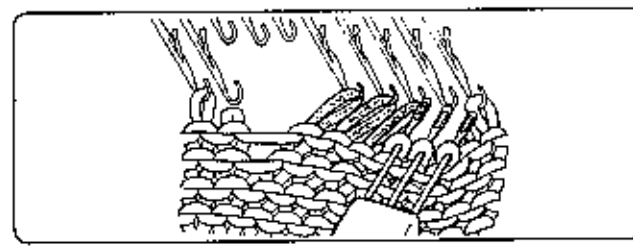
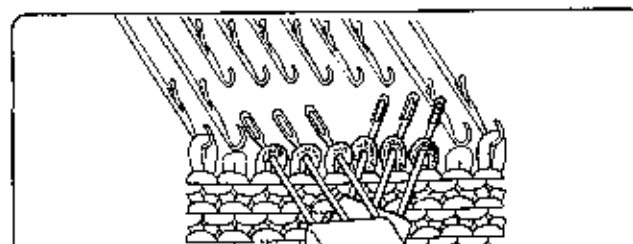

- 4) Allow the stitches on each side of the cable (which you dropped in step 1), to ladder down. Using the Latchet Tool reform them into purl stitches. * Refer to page 46. *

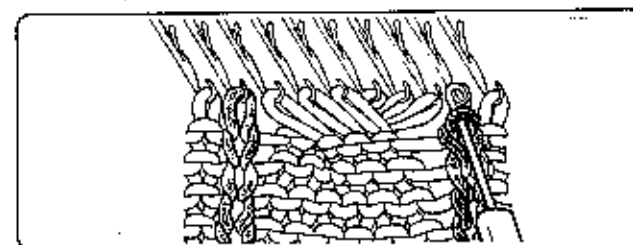

If it is hard to move the Carriage after you cross the stitches, bring forward the needles which have crossed stitches on them to E position before you move the Carriage.

BASIC TECHNIQUES FOR MAKING GARMENTS

1 HOW TO USE THE TRANSFER TOOL

Use when you decrease, increase, transfer stitches, etc.

How to hold the Transfer Tool

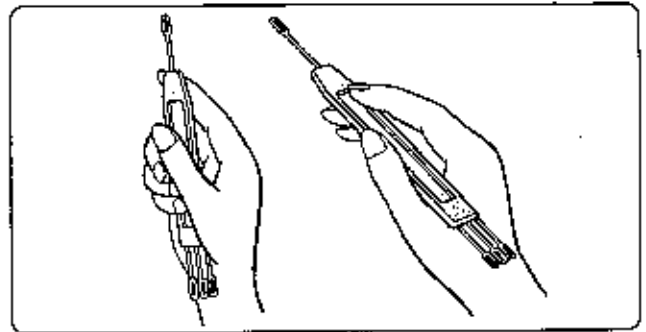

Transferring stitches

1

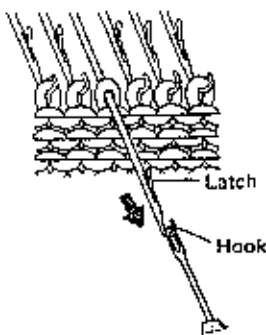

Place the eye of a single Transfer Tool over the needle hook, and pull the needle towards you until stitch passes behind the latch.

2

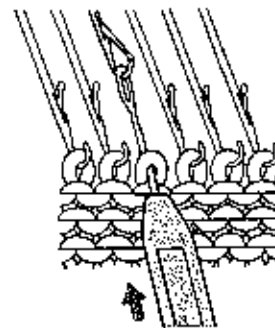

Holding the Transfer Tool in line with the needle, use it to push the needle back so that the stitch slips onto the Transfer Tool.

3

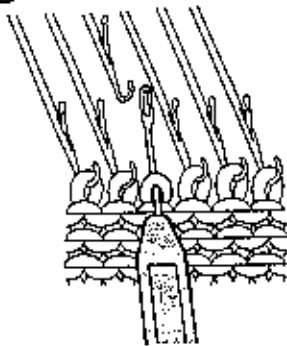

Lift the Transfer Tool together with the stitch, and place it onto the adjacent needle.

4

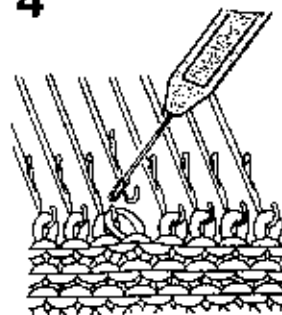

Lift the handle of the Transfer Tool slightly so that the stitch slides off into the hook of the needle. Then remove the Transfer Tool. One stitch has been transferred.

2 HOW TO USE THE LATCHET TOOL

Use the Latchet Tool when you work a welt, pick up dropped stitches, etc.

How to hold the Latchet Tool

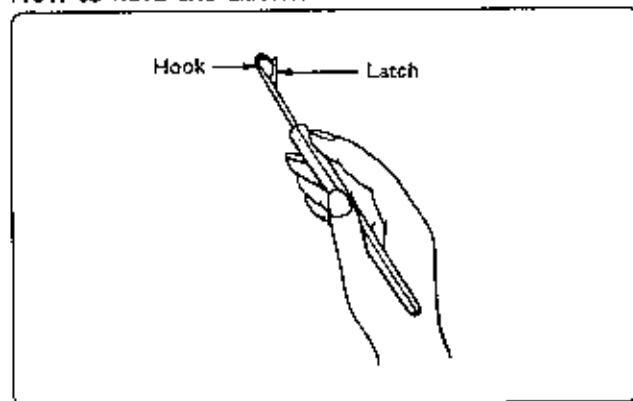

Making a welt by hand

1

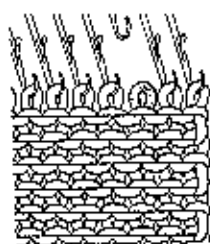

Bring the needle for "purl" stitch forward to E position and then back to B position so that the stitch drops off the needle.

2

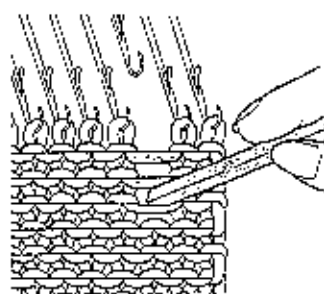

Using the end of your Latchet Tool, ladder the stitch down to within a few rows of the point where you want to start the welt.

3

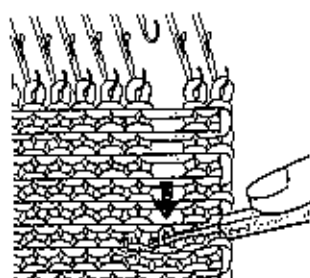

Hook the first stitch where the welt will begin and push down with the Latchet Tool so that the last few stitches drop.

4



Push the Latchet Tool forward to put the first stitch behind the latch and catch the next horizontal bar above with the Latchet Tool. Pull the Latchet Tool towards you.

5

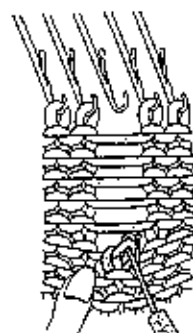

The latch closes with a new stitch in the hook. Gently slip the old stitch off the end of the Latchet Tool.

6

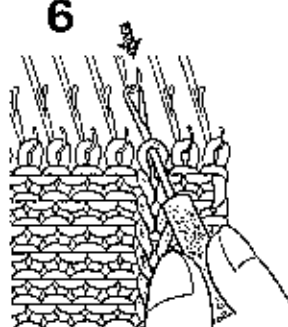

Continue in this way until you reach the top, then hook the last stitch onto the needle as shown.

3 DECREASING STITCHES

Use the Transfer Tool.



Decreasing one stitch . . . simple method

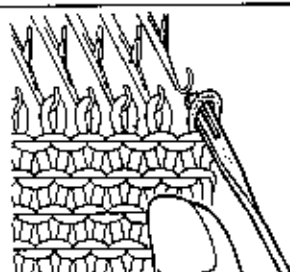

Remove one stitch at the edge onto your Transfer Tool.

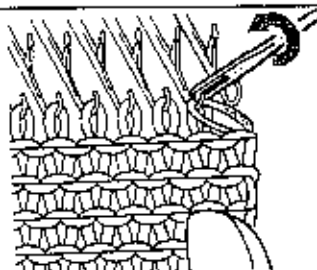

Place the Transfer Tool onto the hook of the adjacent inside needle, and transfer the stitch.

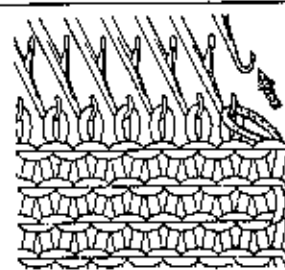

Return the empty needle to A position.

Decreasing one stitch . . . fully fashioned method

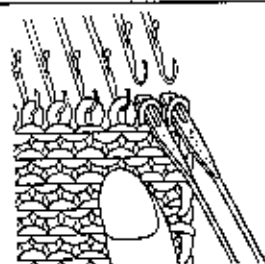

Remove two stitches at the edge using a 2 eyed Transfer Tool.

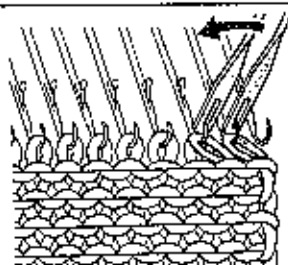

Place the Transfer Tool onto the hooks of the adjacent inside needles, and transfer the stitches.

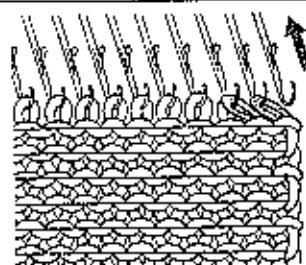

Return the empty needle to A position.

Decreasing several stitches

Carriage and yarn are at the side where you wish to decrease the stitches.

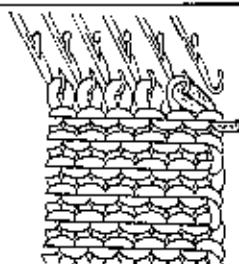

On the Carriage side transfer the end stitch onto the adjacent needle.

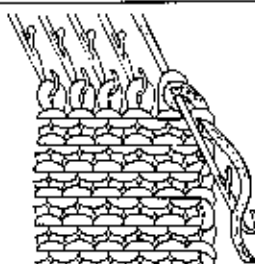

Bring this needle forward and loop the yarn around the needle hook.

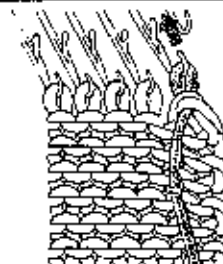

Push the needle back so that a single stitch is formed. Return the empty needle to A position.

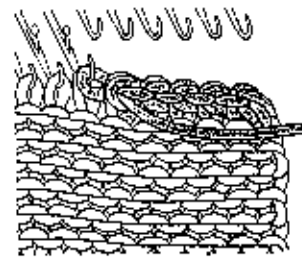

Repeat the same steps, but on the last stitch, only transfer the stitch.

Take care not pull the yarn too hard, or the cast off edge will become too tight.

4 INCREASING STITCHES

Use the Transfer Tool

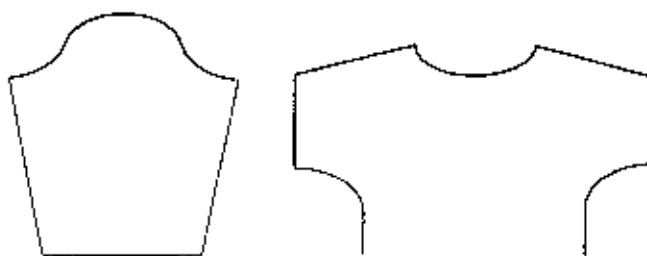

Increasing one stitch . . . simple method

The Carriage and yarn are at the side where you wish to increase the stitch.

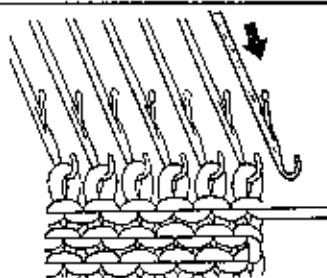

On the Carriage side, bring one edge needle forward from A to B position.

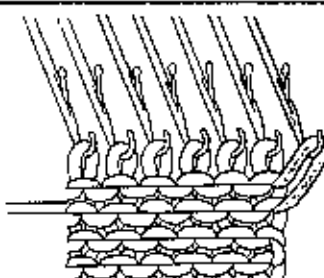

Knit one row to the left. The empty needle picks up the yarn.

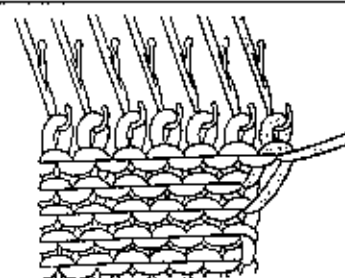

Knit one row to the right. The new stitch knits.

Increasing one stitch . . . fully fashioned method

The Carriage can be at either end of the needlebed.

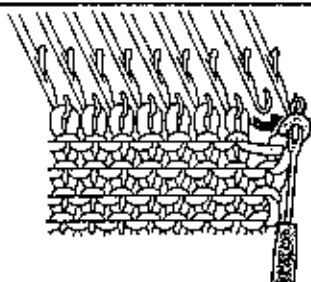

Using the Transfer Tool, transfer the edge stitch to the adjacent outside empty needle (the second needle becomes empty).

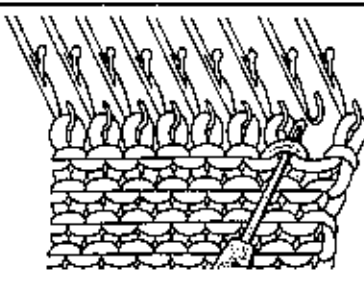

Pick up the horizontal loop from the lower row of the second stitch, from the end.

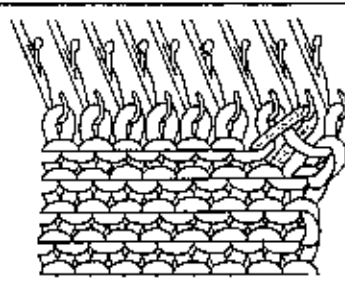

Place this loop onto the empty needle and continue to knit.

Increasing several stitches.

The Carriage and the yarn are at the side where you wish to increase the stitches.

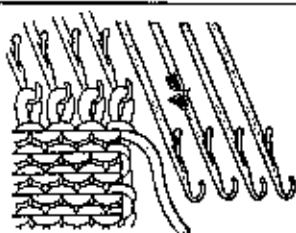

Bring the needles to be increased forward to E position.

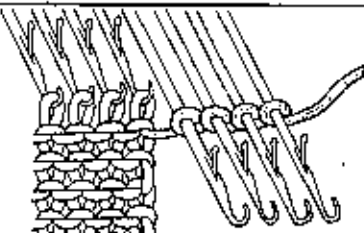

Wind the yarn loosely around the stem of each needle as shown.

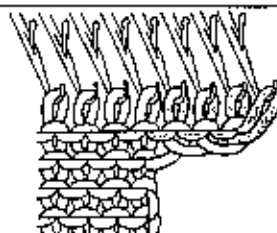

Knit one row pulling up any loose yarn with your hand. Knit two or three rows after pulling the needles containing the new stitches to E position.

■ DECREASING STITCHES

Work decreases for shoulder, neck opening, etc.
This example shows shoulders.



1

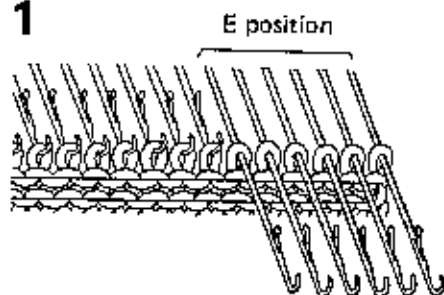

Set the Holding Cam Levers to H. On the opposite side to the Carriage, bring the needles you want to decrease forward to E position.

2

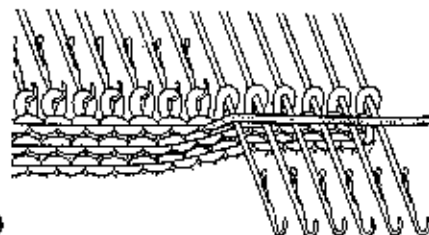

Knit one row. The needles in E position have not been knitted.

3

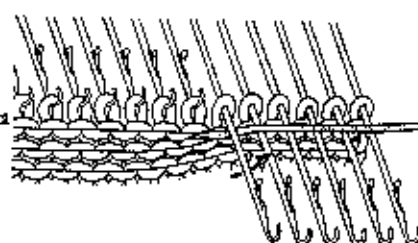

Pass the yarn under the stem of the first needle in E position.

4

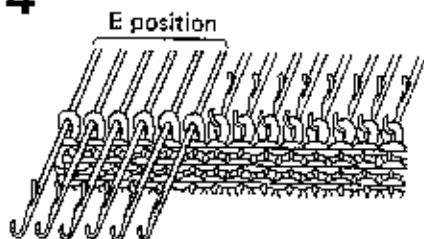

On the opposite side to the Carriage, bring the needles you want to decrease forward to E position.

5

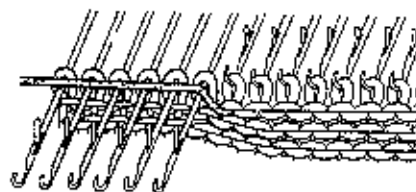

Knit one row. The needles in E position have not been knitted.

6

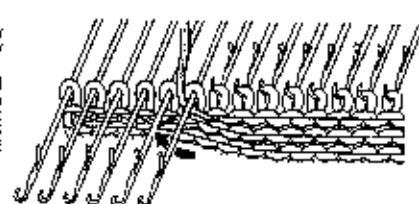

Pass the yarn under the stem of the first needle in E position.

7

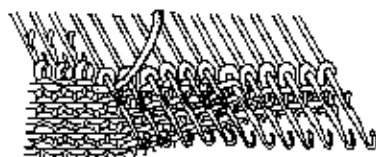

When you want to knit all the needles after partial knitting, return the Holding Cam Levers to N. When the Holding Cam Lever is set to H, needles in E position are not knit. Therefore, if you have brought forward the needles to E position to knit smoothly or to knit pull up stitch pattern, push them back to D position.

Repeat the steps 1 – 6.

■ INCREASING STITCHES

Work increases for hemline of a skirt, dart, etc.
This example shows the hemline.

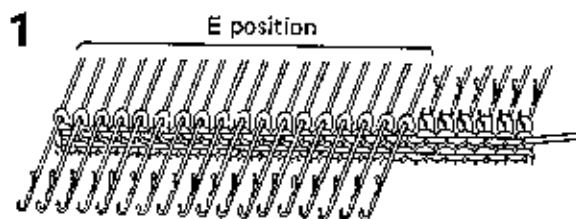
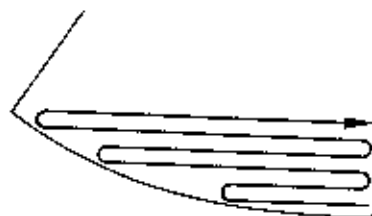

Set the Holding Cam Levers to H. On the opposite side to Carriage, bring forward to E position those needles that you do not want to knit.

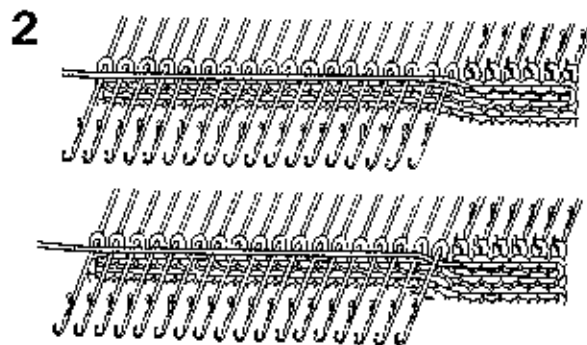

Knit one row. Pass the yarn under the stem of the first needle in E position.

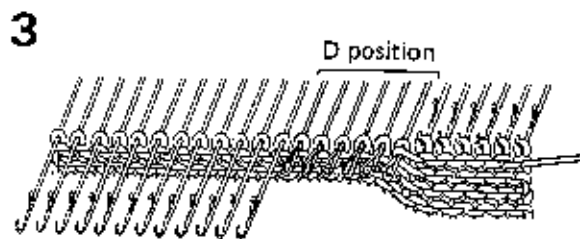

Knit one row and push the needles to be increased from E to D position.

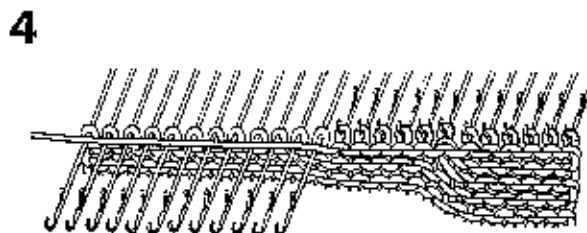

Knit one row. Pass the yarn under the stem of the first needle in E position. Repeat steps 3 – 4. When you want to knit all the needles after partial knitting, return the Holding Cam Levers to N.

When the Holding Cam Lever is set to H, needles in E position are not knit. Therefore, if you have brought forward the needles to E position to knit smoothly or to knit pull-up stitch pattern, push them back to D position.

6 WASTE KNITTING

Waste knitting is the term used to describe knitting that will be removed when the garment is completed, or to enable you to carry out the next step.

■ CASTING-ON

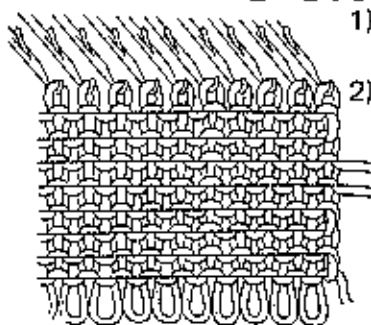

- 1) Knit several rows in waste yarn.
- 2) Unthread the waste yarn and knit in main yarn.

■ CASTING-OFF

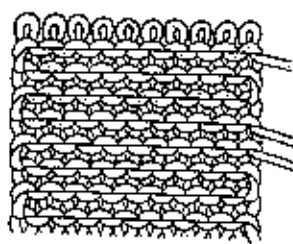

- 1) After the main yarn knitting, unthread the main yarn and knit several rows in waste yarn.
- 2) Run the empty Carriage across the needles to remove the knitting.

Waste yarn is a smooth yarn in a different colour to that of the main yarn, and of a similar thickness to that of main yarn.

7 BACK STITCH

Hold the knitting with the wrong side facing you and fold the waste knitting away from you. Then follow the steps below.

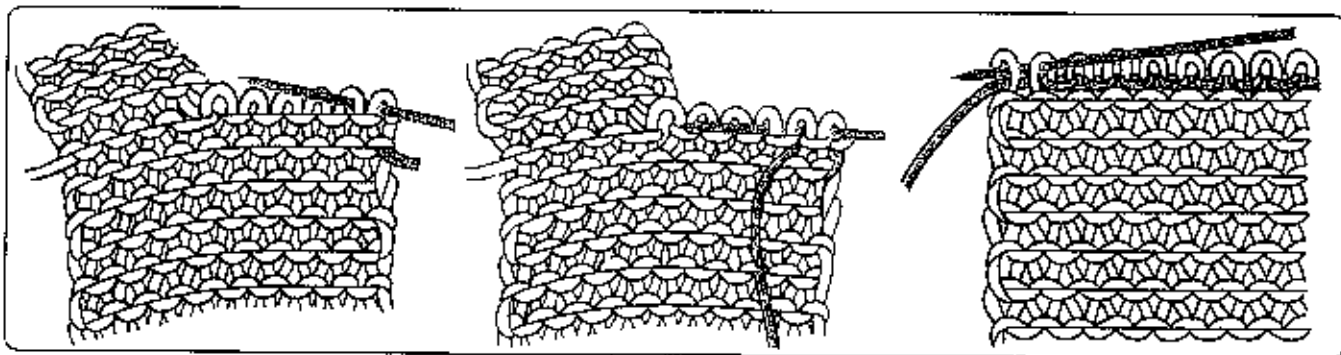

8 REMOVING THE WASTE KNITTING

Just after binding off is completed waste knitting can be unravelled.

*Waste knitting for casting-on is difficult to remove, so cut the end stitch of the last row of waste knitting, and then pull yarn end.

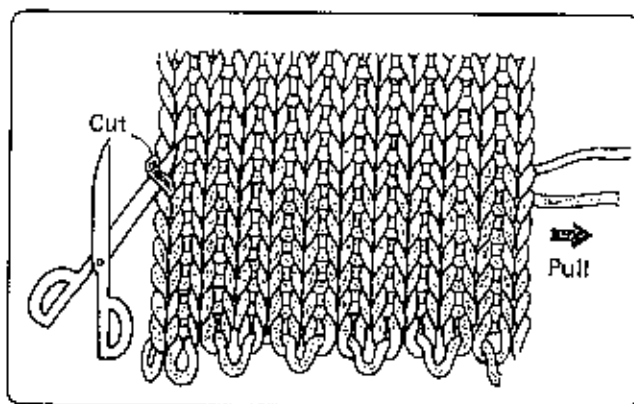

9 CASTING-OFF

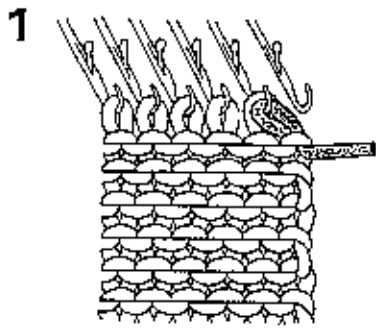
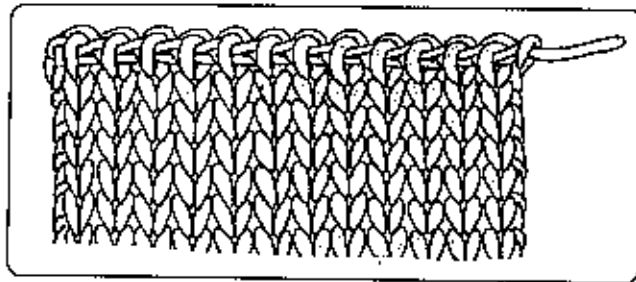

1
On the same side as the Carriage, transfer the end stitch to the 2nd needle.

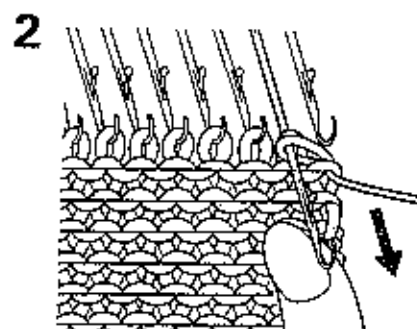

2
Bring forward the needle with two stitches to E position.

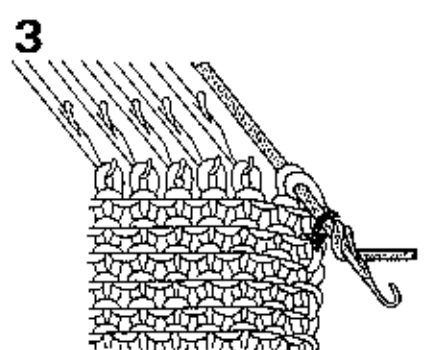

3
Loop the yarn around the stem behind the latch, anticlockwise.

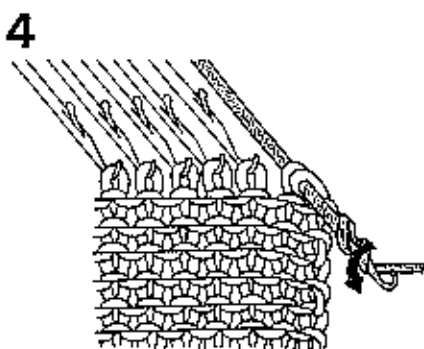

4
Now loop the yarn around the hook of the needle.

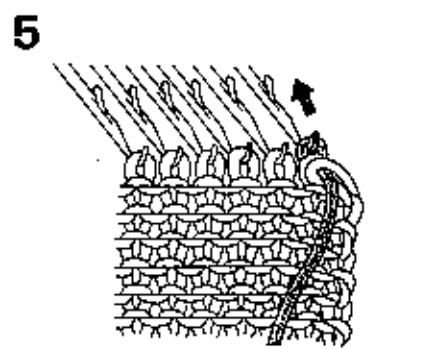

5
Push back the needle to B position.

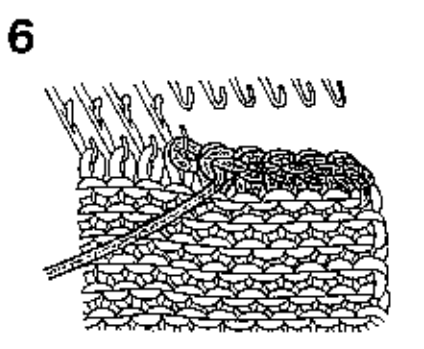

6
Repeat steps 1-5 until cast off edge has been completed.

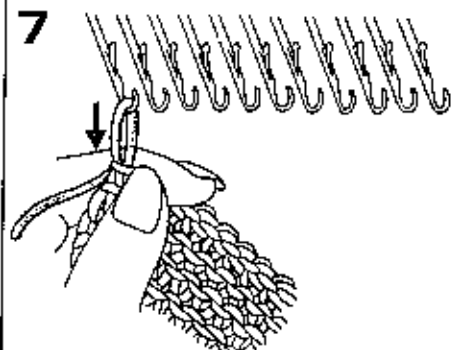

7
Break yarn and pull end through loop of the last stitch. Return all empty needles to A position.

TO BINDING OFF FOR FINISHED EDGE

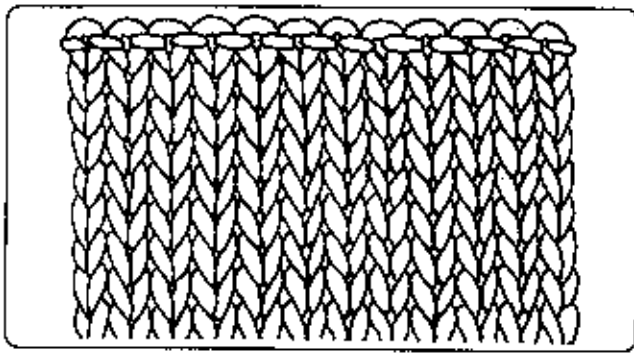

The yarn is on the left-hand side. Take yarn out of the Yarn Feeder and cut it leaving a length three times the width of the knitting. (If the yarn is on the right, use another strip of yarn.) Knit a few rows in waste yarn.

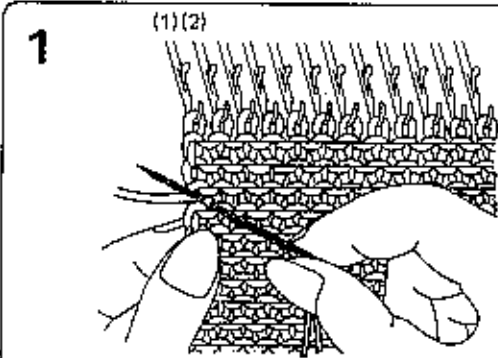

1 Thread yarn end into a Tapestry Needle. From the back, pass needle through the first stitch at the left (1).

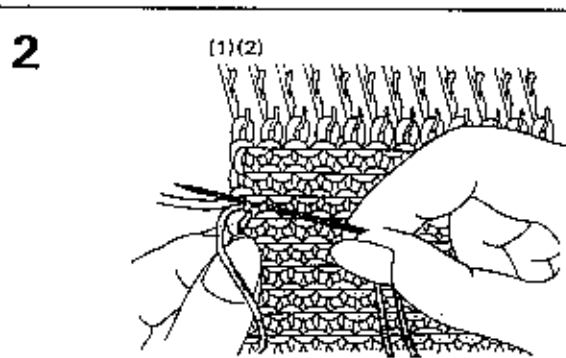

2 From the front, insert the needle in through the second stitch (2) and back out through the first stitch (1).

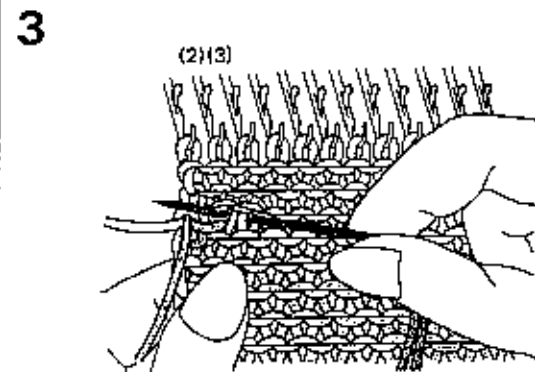

3 From the front, insert the needle in through the third stitch (3) and back out through the second stitch (2).

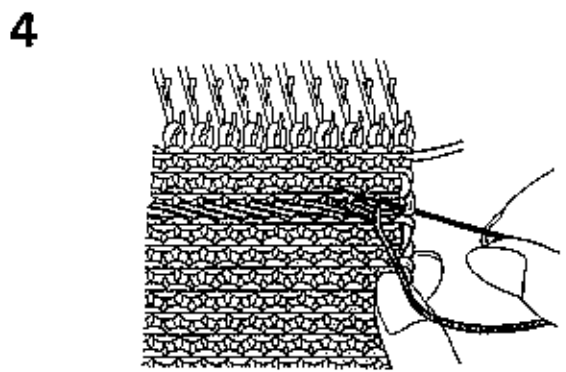

4 Continue in this way until you reach the right-hand edge of the knitting. After releasing the knitting from the machine, remove the waste knitting.

11 PICKING UP THE STITCHES

From the wrong side

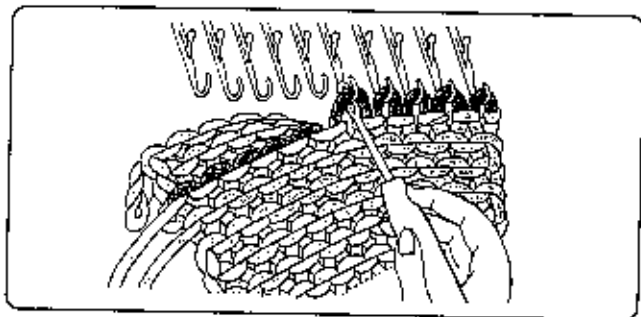

Fold the waste knitting towards the machine.

From the right side

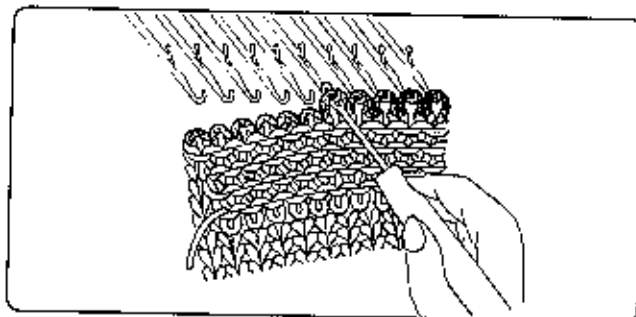

Fold the waste knitting towards you.

12 PICKING UP THE SIDE EDGE STITCHES

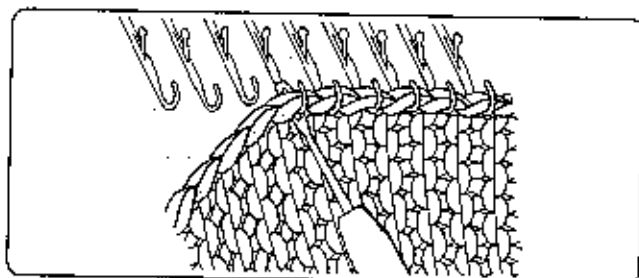

Pick up the edge stitches with the Transfer Tool and hook them onto the hooks of the needles.

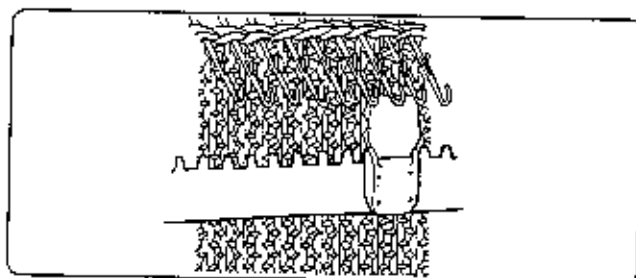

Bring forward the needles to E position holding the knitting so that it does not come towards you. Hang the Cast-on Comb and Claw Weights and knit.

13 BINDING OFF ON THE MACHINE TO JOIN THE KNITTING

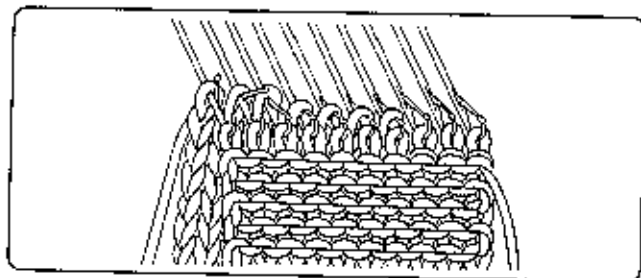

Pick up all the stitches of the first swatch with its right side facing you. All the stitches of the second swatch with its wrong side facing you and push back all of the first swatch stitches behind the latches. Pass all the stitches over the latches of the needles to make a single stitch.

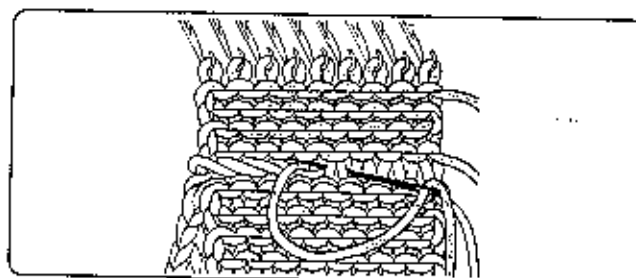

Knit a few rows in waste yarn. Bind off all stitches with the Tapestry Needle referring to page 53.

*If the yarn is on the right, use another strip of yarn. After releasing the knitting from the machine, remove the waste knitting.

14 SEAMING

■ STOCKING STITCH

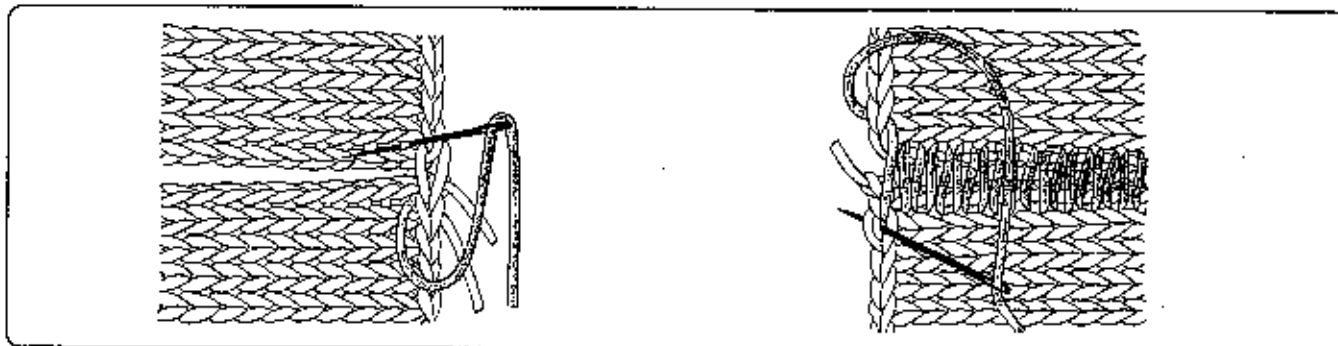

■ 2x1 WELT

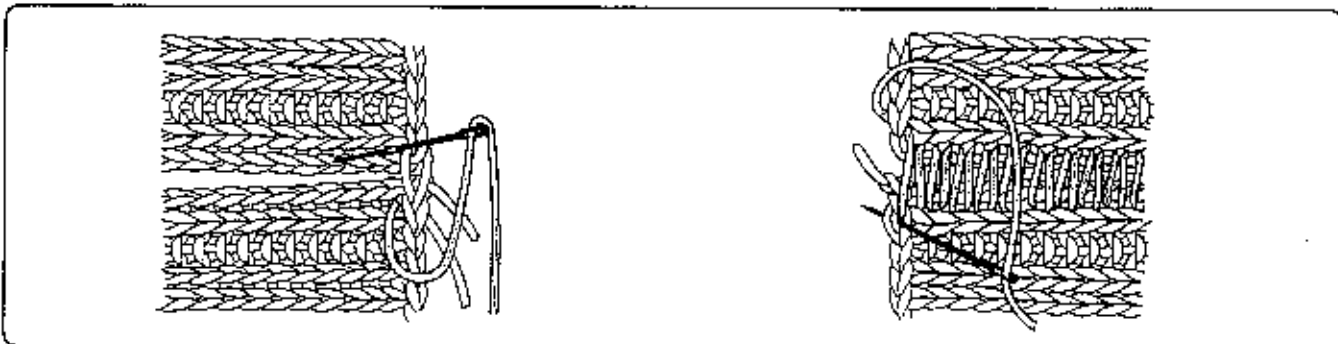

■ EDGE WHERE YOU INCREASE STITCHES

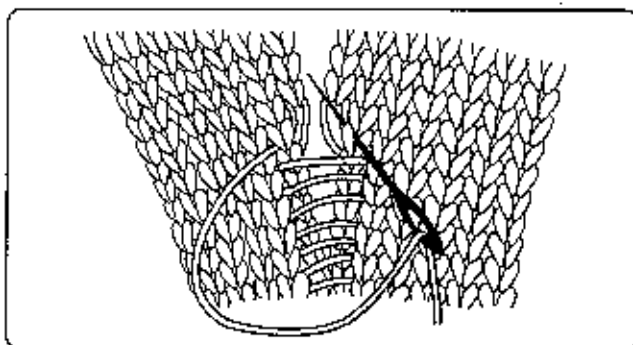

15 FINISHING

■ ON THE EDGE OF A SWATCH

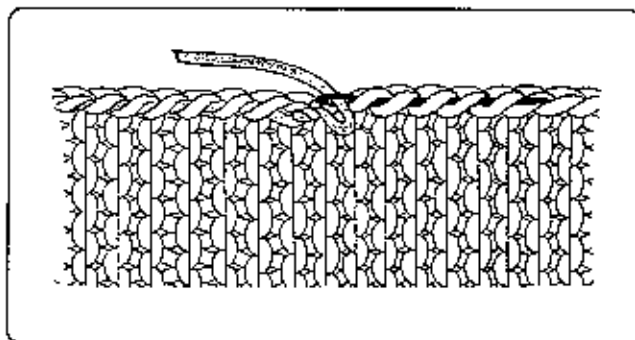

■ IN THE MIDDLE OF A SWATCH

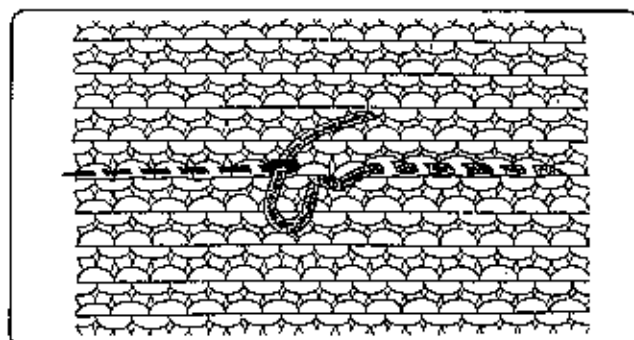

USEFUL HINTS (PROBLEMS DURING KNITTING)

1 WHAT TO DO WHEN YOU CANNOT KNIT SMOOTHLY

■ WHEN THE NEEDLES DO NOT CATCH THE YARN CORRECTLY

Is the yarn correctly located in the Yarn Feeder?

Is the Carriage set correctly on the needlebed?

Are the Part Levers set to N?

Are the Holding Cam Levers set to N?

Make sure that the yarn is flowing freely from the cone or ball.

■ WHEN THE CARRIAGE IS HARD TO PUSH BACK AND FORTH

Make sure that the Tension Dial is adjusted according to the thickness of your yarn (See page 5)

Make sure that the yarn is flowing freely from the cone or ball.

Is the Carriage knocking against the butt of a needle? If so, arrange the needle to the proper position.

Are there any knots in the yarn?

Does the machine need oiling? (See page 60)

■ WHEN STITCHES ARE NOT FORMED CORRECTLY

Is the needle bent? If so, change it for a new one (see p. 60).

If you move the Carriage far beyond the knitting, end stitches are apt to drop because of the loose tension. Therefore do not move the Carriage too far beyond the knitting.

Rehang the Cast-on Comb when the knitting becomes long. Rehang the Claw Weights onto the edge of the knitting.

2 HOW TO PICK UP A DROPPED STITCH

■ REPAIRING A DROPPED STITCH

Insert the Transfer Tool into the stitches on the row below the dropped stitch as illustrated.

1

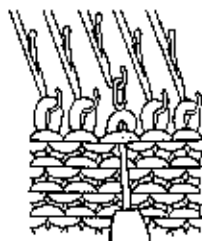

2

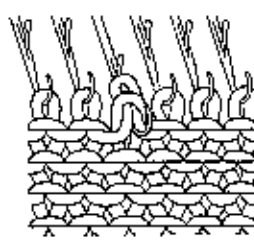

3

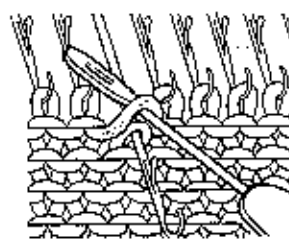

4

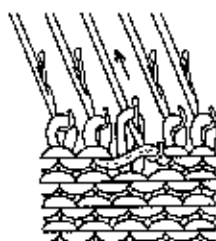

5

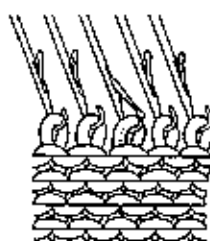

■ REPAIRING A DROPPED STITCH THAT HAS DROPPED SEVERAL ROWS

Use the Latchet Tool from behind, and hook up the first stitch. Remake the dropped stitches row by row. On the final row, transfer the stitch from the Latchet Tool to a Transfer Tool, and replace it onto the needle.

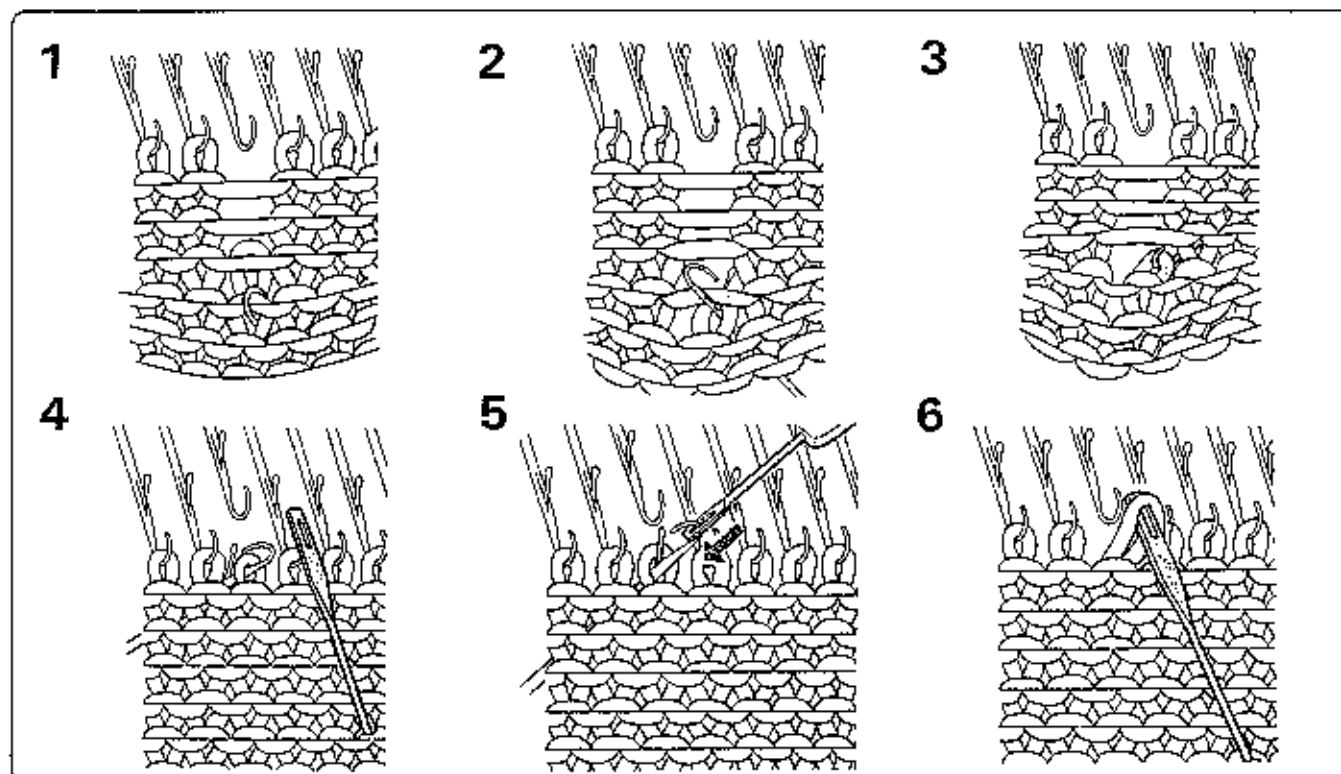

3 WHAT TO DO IF YOU MAKE MISTAKES AS YOU KNIT

■ IF THE CARRIAGE SHOULD JAM

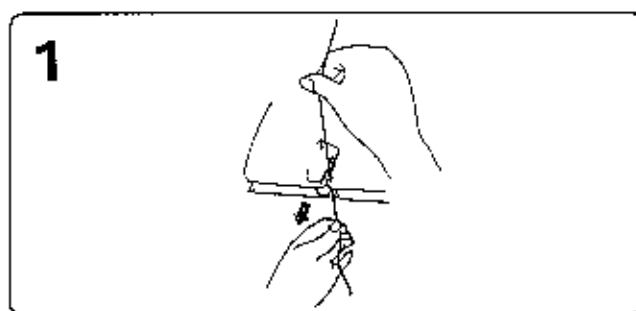

Take the yarn out of Yarn Feeder.

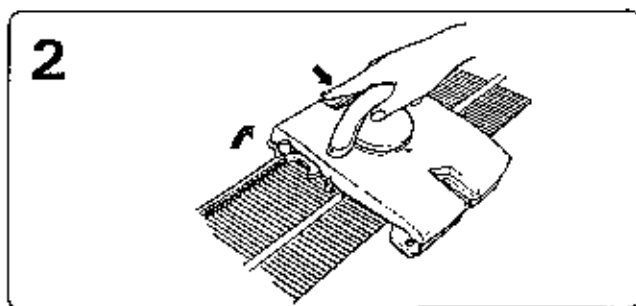

Push the Carriage Release Button and lift up the Carriage towards you to remove the Carriage from the needlebed.

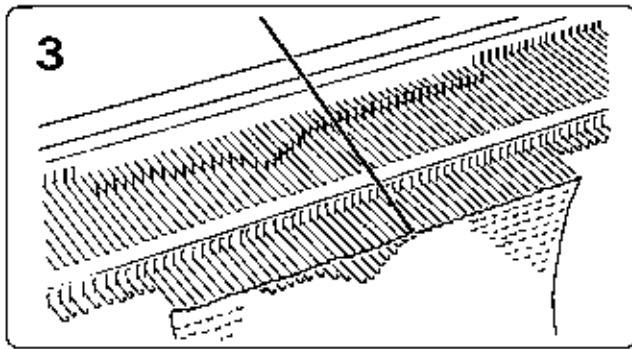

Using your Transfer Tool, replace any stitches that are on the stems of the needles back into the hooks, so that they will not drop off (the following steps illustrate this technique).

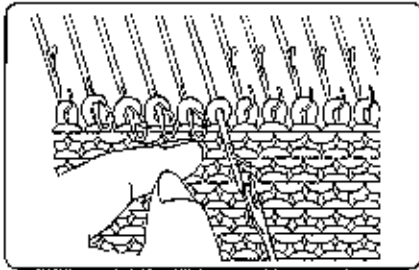
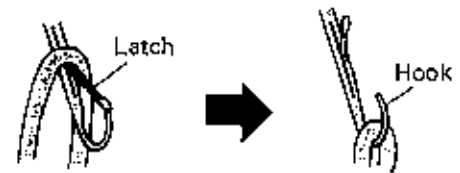

Place the eye of the Transfer Tool into the hook of the needle. Hold the Transfer Tool in line with the needle and pull it towards you.

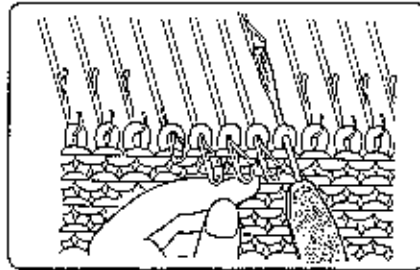

Push the Transfer Tool away from you towards the machine until the stitch is on the Transfer Tool.

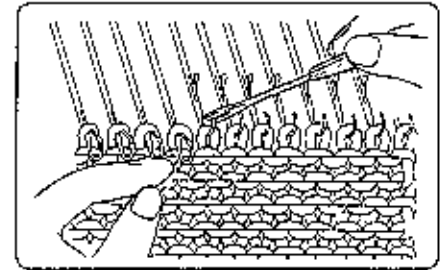

Transfer the stitch into the hook of the needle.

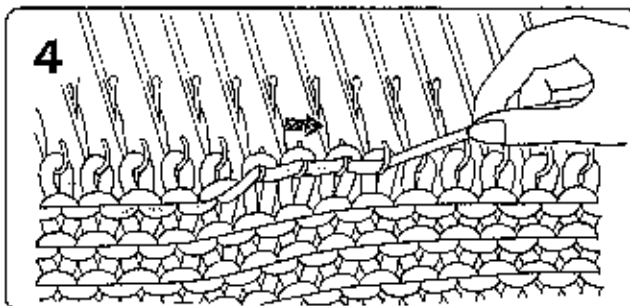

When all stitches are safely in the hooks of the needles, align all needles in B position using the Needle Pusher.

Pull the yarn sideways slightly so that it becomes tight in the needle hooks.

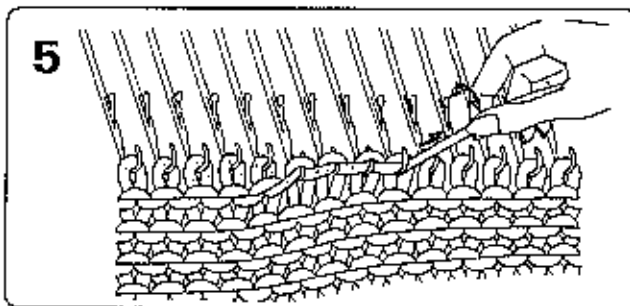

Now pull the yarn in an upwards direction to unravel the knitting. The stitches are undone and those from the row below will slip into the needle hooks. Work a few stitches at a time and repeat steps 4 – 5 across the row.

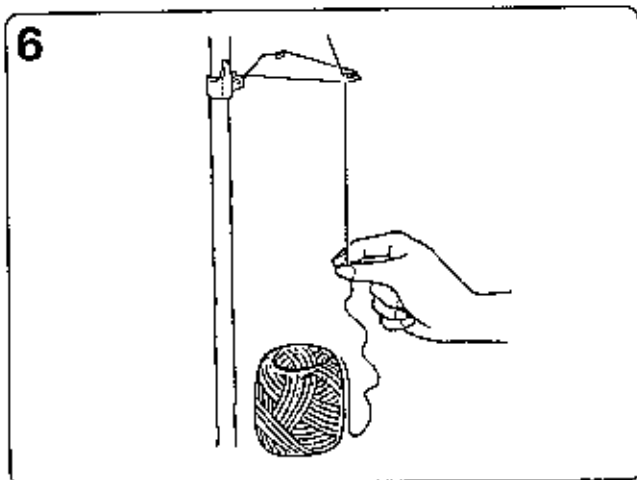

Pull down the loose unraveled yarn from behind the Rear Yarn Guide.

To unravel several rows of knitting, repeat steps 4 – 6.

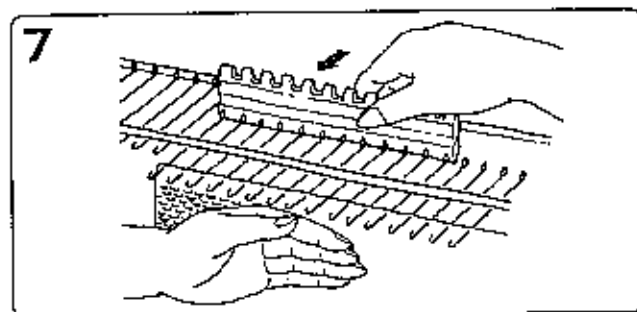

Bring forward the needles to E position holding the knitting so that it does not come towards you. Wind back the Row Counter the number of rows you have unraveled.

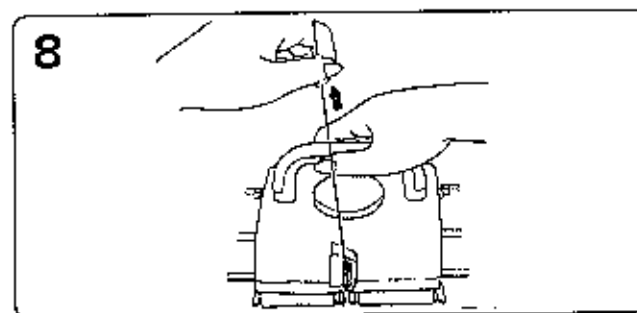

Thread the yarn into the Yarn Feeder. Continue knitting with the Carriage, pulling the yarn slightly on the first row to remove any slackness.

■ IF YOU WANT TO UNRAVEL SOME KNITTING

Should you wish to unravel a row or rows of knitting, if for example you find you have knitted too many, follow steps 4 – 8.

LOOKING AFTER YOUR MACHINE

1 REPLACING A NEEDLE

Needles that are bent, broken or damaged will cause problems during knitting. If you experience dropped or badly knitted stitches you should check the needles and replace any faulty ones immediately. In an emergency if you have no spare needles, use one from the extreme edge of the needlebed.

1

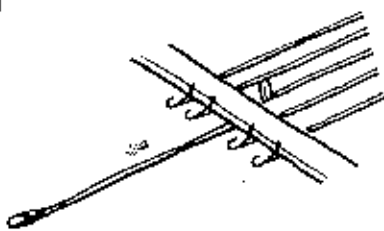

Push the faulty needle forward to E position with the latch closed.

2

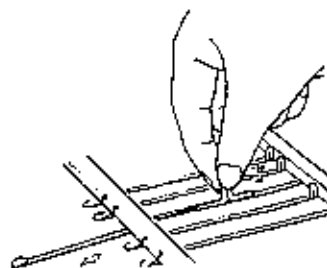

Catch hold of the shank end and lift the faulty needle out from the needlebed.

3

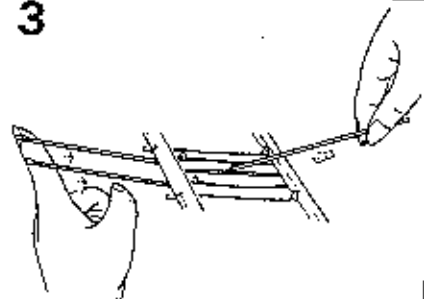

Bring forward the next needles on both sides to E position. With the latch open, insert the new needle lifting up the two needles.

2 CLEANING AND MAINTENANCE

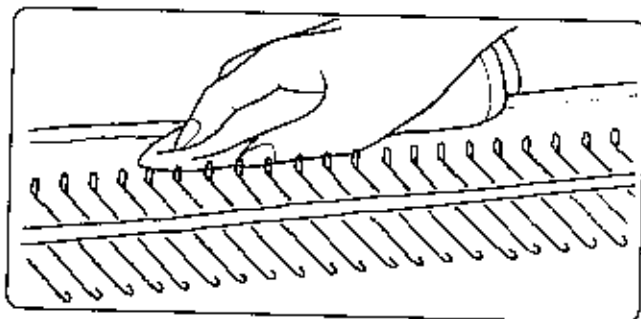

Clean plastic parts with a soft cloth and mild, neutral detergent.

*Do not use alcohol, benzine, thinners or petrol.

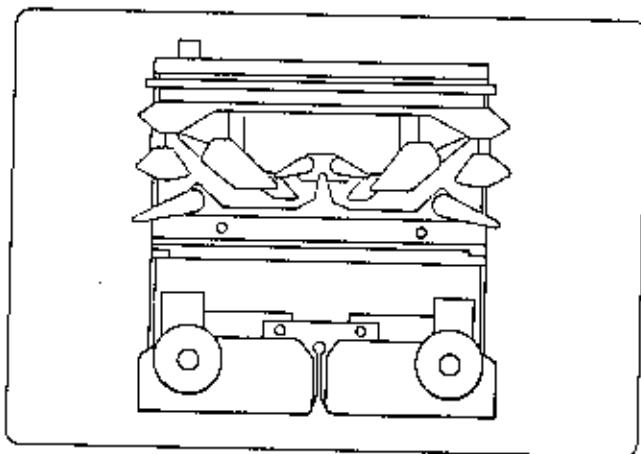

Lubricate the needlebed, rear and front rails, needle butt, and the areas indicated above using an oily cloth (silicone oil).

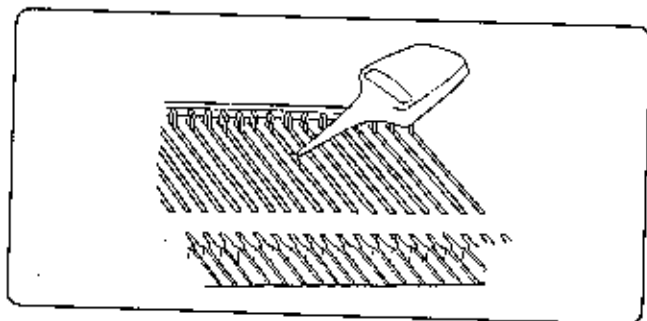

Should the Carriage feel heavy to operate, you should lubricate needlebed (especially into the slit) and wipe off the excessive oil. (You cannot use the oil except silicone oil). If you regularly clean and lightly oil your machine, it will make knitting easier and help to prevent excessive wear.

*When you come to use your machine again after you have stored it for a while, knit 20 - 30 rows with waste yarn to clean away any dirty oil.

HOW TO REPLACE THE KNITTING MACHINE

